

Penn State Industries Bushing Book

HOW TO USE THIS DOCUMENT

Welcome to the Bushing Book from Penn State Industries. This document covers bushings, trimming sleeves and chucks that are used to turn and size your project. The bushings are listed in the Table of Contents and the corresponding page matches the page number of the PDF document page. The document is broken up into three sections.

The first section has specification sheets for each bushing. The last three sections are Appendices. The List by Kit appendix is a listing of each series of kit and the bushing used for that kit. The second appendix lists each bushing and all kits that use that bushing. The Diameter Index is a list of the diameter measurements for each section of the bushings to make it easier to identify bushings that have become mixed up. Remember that there will be slight variations for tolerances and wear from use. If variation exceeds .005", consider replacing bushing.

The specification sheets consist of a simplified drawing of the item with each section marked off for length and diameter. The type of product is listed on each page. The drawing is representative and is made to relative scale, not exact scale. Each part (e.g. tip, center) and each section is named to help distinguish what section of the kit the part is for. Some sets contain more than one of a particular part. Next to each part name is a number in parenthesis noting how many will come in the set. At the bottom of each page is a list of Kit Item Numbers for kits that use the bushing.

This document is searchable through several methods. It can be searched by the Bushing Item Number, or it can be searched by the Kit Series Number. This is the part of the kit item code that does not include the finish. For example the Bolt Action Series Number would be "PKCP80(XX)" the last 2 numbers of a Bolt Action Kit reference the finish of the kit and are not listed individually in this document for reasons of space. You can also search for "BOLT" which would take you to the appendix pages which will tell you which bushing is used by the Bolt Action Pens.

FAQ SHEET

What is a Bushing?

A bushing is used to support the turning projects from Penn State while mounted on the mandrel. When mounted, these bushings act as a size guide to help make sure that when the turned piece is combined with the kit hardware, the places where they meet will match.

What is a Barrel and what is an Extension?

A Barrel means that that section is intended to mark the outside diameter that the turned piece must be cut to. This is the part that the kit hardware will be next to and this is the size intended to make sure the turned piece matches that hardware. The Extension is intended to fit inside the tube that is glued into the turning material. The Penn State mandrel systems all have a single mandrel rod size. The Extension acts as a bridge to fit on the rod and act as a support for larger tubes.

Why are some pieces are marked “upper” or “lower”?

This is mostly on bushings that are intended to fit in between two turned portions of a single kit. This helps point out which section of the assembled kit these parts should be oriented towards. The upper side will generally be the one that points towards the top of the pen, and the bottom will generally refer to the side that the tip is on.

What is a Trimming Sleeve?

The PSI Barrel Trimmer systems have a pilot shaft designed to help line up the trimming surface with the tube inside the turning material. The Sanding Disc systems have a 7mm pilot shaft meant to be aligned 90° to a sanding disc. The Barrel Trimmers have cutting heads mounted on pilot shafts. These shafts come in 4 basic sizes: 7mm, 8mm, 10mm, and 3/8”. Some tubes are larger than these sizes. The Barrel Trimming Sleeves are meant to be inserted in the tube and the internal hole in the sleeve guides the Trimmer Pilot Shaft helping to maintain the alignment between the trimmer and the tube.

What is an Internal Bushing?

Internal bushings are meant to act like Extensions. Mostly used in closed end kits, they support the tube, but do not have exposed sections for sizing the outer barrel of the pen.

What is a Drill Chuck Mandrel?

Drill chuck mandrels are for turning vanity projects, such as a Purse Hanger. They are mounted in a drill chuck and the material is attached to the

TABLE OF CONTENTS

BS11GSBU.....	11
BS12GABU.....	12
BS15BU.....	13
BS25XBU.....	14
BS6-BU.....	15
BSLEDBU.....	16
KSEG-M.....	17
KSNECBU.....	18
PK10-BUSH3.....	19
PK50BABU.....	20
PK50CALBU.....	21
PK50CALPBU.....	22
PK50RBU.....	23
PKABBU.....	24
PKANVBU.....	25
PKAPBBU.....	26
PKAPBTS.....	27
PKAPCEBU.....	28
PKAPFILBU.....	29
PKAPR2BU.....	30
PKARTBU.....	31
PKATHNBU.....	32
PKATOM-BU.....	33
PKATOMKCBU.....	34
PKAUTOBU.....	35
PKBASEBU.....	36
PKBCMBU.....	37
PKBCPBU.....	38
PKBEGBU.....	39
PKBELBU.....	40

TABLE OF CONTENTS

PKBHOLDBU.....	41
PKBIG-BU.....	42
PK-BS1-MJ.....	43
PKBS28CBU.....	44
PKBSBU.....	45
PKBULPENBU.....	46
PKCAMBU.....	47
PKCEOBU.....	48
PKCFBUSH.....	49
PKCHPENBU.....	50
PKCKBU.....	51
PKCLBU.....	52
PKCLFPBU.....	53
PKCMRBU.....	54
PKCONBU.....	55
PKCORBU.....	56
PKCP2400BU.....	57
PKCP3000BU.....	58
PKCP6000BU.....	59
PKCP7000BU.....	60
PKCP9000BU.....	61
PKCPENRBU.....	62
PKCSCOOPBU.....	63
PKCTPENBU.....	64
PKCWPENBU.....	65
PKDBBUA.....	66
PKDCM100.....	67
PKDCM125.....	68
PKDCM150.....	69
PKDCM1916.....	70

TABLE OF CONTENTS

PKDCM200.....	71
PKDCMBS.....	72
PKDCMPT.....	73
PKDET2BU.....	74
PKDRABU.....	75
PKDRIP7BU.....	76
PKDRIP8BU.....	77
PKDRRBU.....	78
PKDSTYBU.....	79
PKDUSLIMBU.....	80
PKDWBU.....	81
PKEXEC-BU.....	82
PKEXECRBU.....	83
PKEZBU.....	84
PKFBALLBU.....	85
PKFCBU.....	86
PKFEDBU.....	87
PKFILBU.....	88
PKFIREBU.....	89
PKFLYRBU.....	90
PKFP4500BU.....	91
PKFP5000BU.....	92
PKFPBU.....	93
PKFPENBU.....	94
PKGABTS.....	95
PKGABU.....	96
PKGAFBU.....	97
PKGDJRBU.....	98
PKGDPENBU.....	99
PKGDRBBU.....	100

TABLE OF CONTENTS

PKGDRBTS.....	101
PKGOLFBU.....	102
PKGRAD2BU.....	103
PKGRADB.....	104
PKGRAPBU.....	105
PKGREATBU.....	106
PKGRENBU.....	107
PKGRIND7BU.....	108
PKGRIND8BU.....	109
PKHGBU.....	110
PKHPENBU.....	111
PKHPRBU.....	112
PKISCOOPBU.....	113
PKJPENBU.....	114
PKKNBU.....	115
PKL750BU.....	116
PKL760BU.....	117
PKLBALMBU.....	118
PKLEVB.....	119
PKLONGBU.....	120
PKLPULLFB.....	121
PKLSBU.....	122
PKMAGNECB.....	123
PKMAJBTS.....	124
PKMAJBU.....	125
PKMAJRBTS.....	126
PKMAJRBU.....	127
PKMAJLOBU.....	128
PKMAJSQBU.....	129
PKMAYBU.....	130

TABLE OF CONTENTS

PKMBEADY.....	131
PKMBL105.....	132
PKMBL125.....	133
PKMBL1532.....	134
PKMBL2564.....	135
PKMBL3164.....	136
PKMBL3364.....	137
PKMBL916.....	138
PKMBLCBU.....	139
PKM-BUSH3.....	140
PKMINCLKBU.....	141
PKMJRCBU.....	142
PKMONT2-BU.....	143
PKMONT3BU.....	144
PKMONT-BU.....	145
PKMONT-BU2.....	146
PKMONT-BUX.....	147
PKMONTL2BU.....	148
PKMONTPRBU.....	149
PKMOONBU.....	150
PKMSPBU.....	151
PKMT7BU.....	152
PKMUSBU.....	153
PKMUSRBU.....	154
PKNICK-BU.....	155
PKOL2BU.....	156
PKOLBTS.....	157
PKOLCEBU.....	158
PKPAR10-B2.....	159
PKPARK-BU.....	160

TABLE OF CONTENTS

PKPATDSBU.....	161
PKPATPENBU.....	162
PKPCUBU.....	163
PK-PENXXBU.....	164
PKPERF-BU.....	165
PKPHANGM.....	166
PKPIRBU.....	167
PKPLI2-BU.....	168
PKPLI-BU.....	169
PK-POLBU.....	170
PKPOLICEBU.....	171
PKPOWBU.....	172
PKPPENBU.....	173
PKPPRBBU.....	174
PKPRPENBU.....	175
PKPT100BU.....	176
PKPURSEBU.....	177
PKPUTBU.....	178
PKRAHANBU.....	179
PKRASAF2BU.....	180
PKRASTBU.....	181
PKREVB.....	182
PKSANDPBU.....	183
PKSAPENBU.....	184
PKSC-BU.....	185
PKSDPENBU.....	186
PKSEGPENBU.....	187
PKSEPILLBU.....	188
PKSERBU.....	189
PKSHAKEBU.....	190

TABLE OF CONTENTS

PKSKULLBU.....	191
PKSKULLRBU.....	192
PKSPBU.....	193
PKSPCL2BU.....	194
PKSPCL3BU.....	195
PKSPCLBU.....	196
PKSPDRBU.....	197
PKSPENBU.....	198
PKSPKSBU.....	199
PKSPRTBU.....	200
PKSRBU.....	201
PKSTANDYBU.....	202
PKSWPBU.....	203
PKTANKBU.....	204
PKTOOL2BU.....	205
PKTPENBU.....	206
PKTS100BU.....	207
PKTSTECBU.....	208
PKTYBTS.....	209
PKTYBU.....	210
PKTYCEBU.....	211
PKVESBU.....	212
PKVICBU.....	213
PKVICRBU.....	214
PKVPENBU.....	215
PKWDYBU.....	216
PKWESTBU.....	217
PKXMBU.....	218
PKYOGABU.....	219
ZTRIMSET01.....	220

TABLE OF CONTENTS

ZTRIMSET02.....	221
ZTRIMSET03.....	222
ZTRIMSET04.....	223
ZTRIMSET05.....	224
ZTRIMSET06.....	225
ZTRIMSET07.....	226
ZTRIMSET08.....	227
ZTRIMSET09.....	228

APPENDICES

APPENDIX A - GROUPED BY KIT.....	229
APPENDIX B - GROUPED BY BUSHING.....	235
APPENDIX C - DIAMETER INDEX.....	245

PICTURE IS AN APPROXIMATE REPRESENTATION. NOT TO EXACT SCALE OR PROPORTION. ALL MEASUREMENTS IN INCHES. BUSHING DIAMETERS (TOP ROW) ARE OPTIMAL AND SHOULD VARY BY NO MORE THAN .002" WHEN NEW.

**ID NUMBER BS11GSBU
NUMBER OF PARTS 2**

TYPE: BUSHING

NOTES: TOP SIDE FITS INTO RECESS DRILL IN THE TOP OF BLANK

THRU HOLE STANDARD (0.248')

PART NAME AND (QUANTITY)

SECTION NAME

DIAMETER

BASE (1)

TOP (1)

BARREL

RECESS BUSHING

0.620"

0.875"

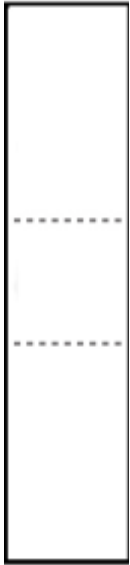
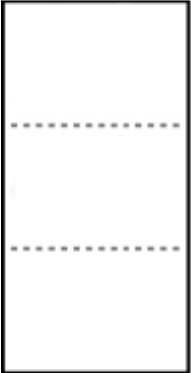

LENGTH

0.377"

0.100"

**ASSOCIATED BS11GS(XX)
KITS:**

PICTURE IS AN APPROXIMATE REPRESENTATION. NOT TO EXACT SCALE OR PROPORTION. ALL MEASUREMENTS IN INCHES. BUSHING DIAMETERS (TOP ROW) ARE OPTIMAL AND SHOULD VARY BY NO MORE THAN .002" WHEN NEW.

ID NUMBER BS12GABU

TYPE: BUSHING

NOTES:

NUMBER OF PARTS 2

THRU HOLE STANDARD (0.248')

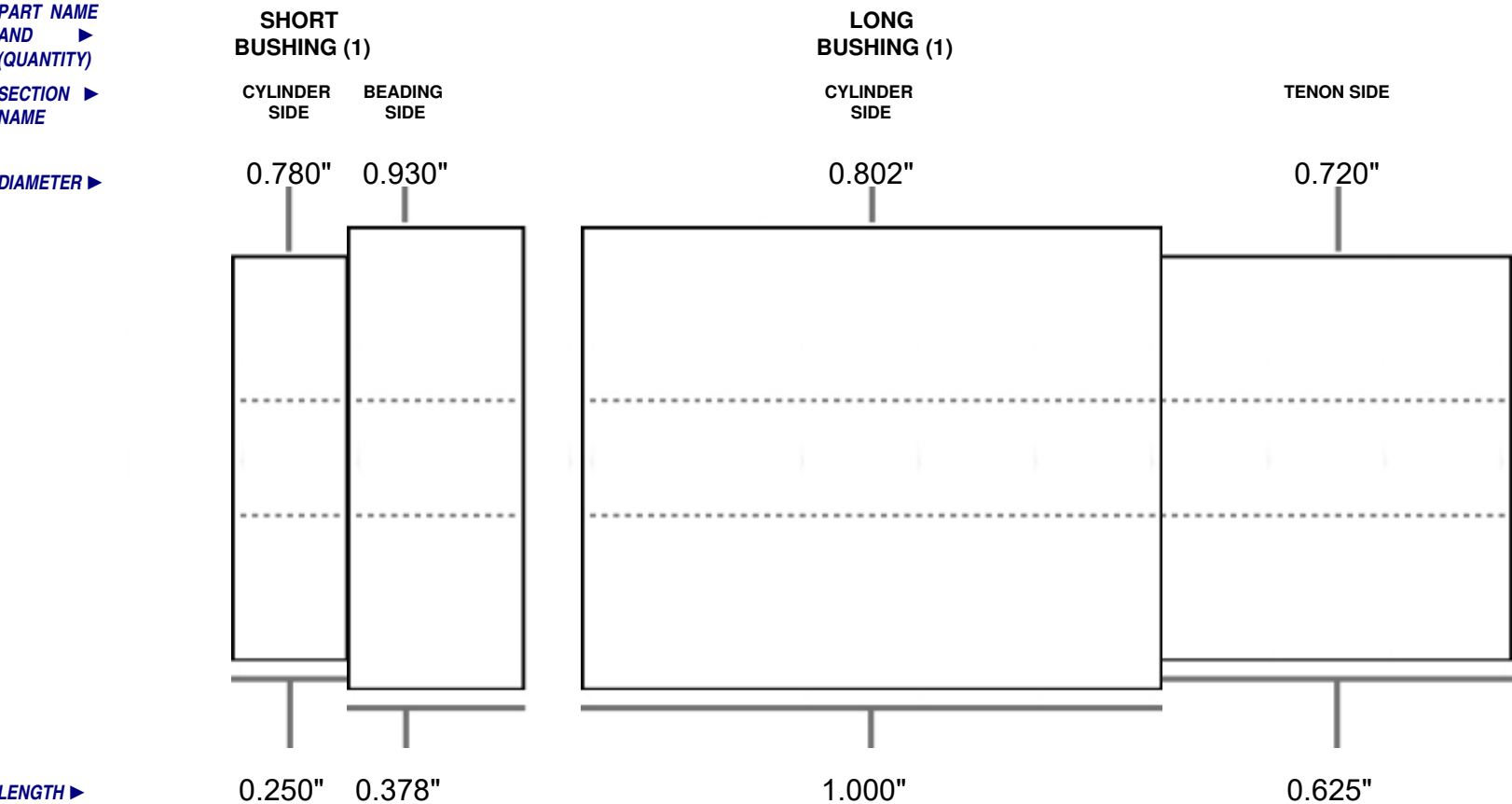

ASSOCIATED BS12GA(XX)
KITS:

PICTURE IS AN APPROXIMATE REPRESENTATION. NOT TO EXACT SCALE OR PROPORTION. ALL MEASUREMENTS IN INCHES. BUSHING DIAMETERS (TOP ROW) ARE OPTIMAL AND SHOULD VARY BY NO MORE THAN .002" WHEN NEW.

ID NUMBER BS15BU

TYPE: BUSHING

NOTES:

NUMBER OF PARTS 2

THRU HOLE STANDARD (0.248")

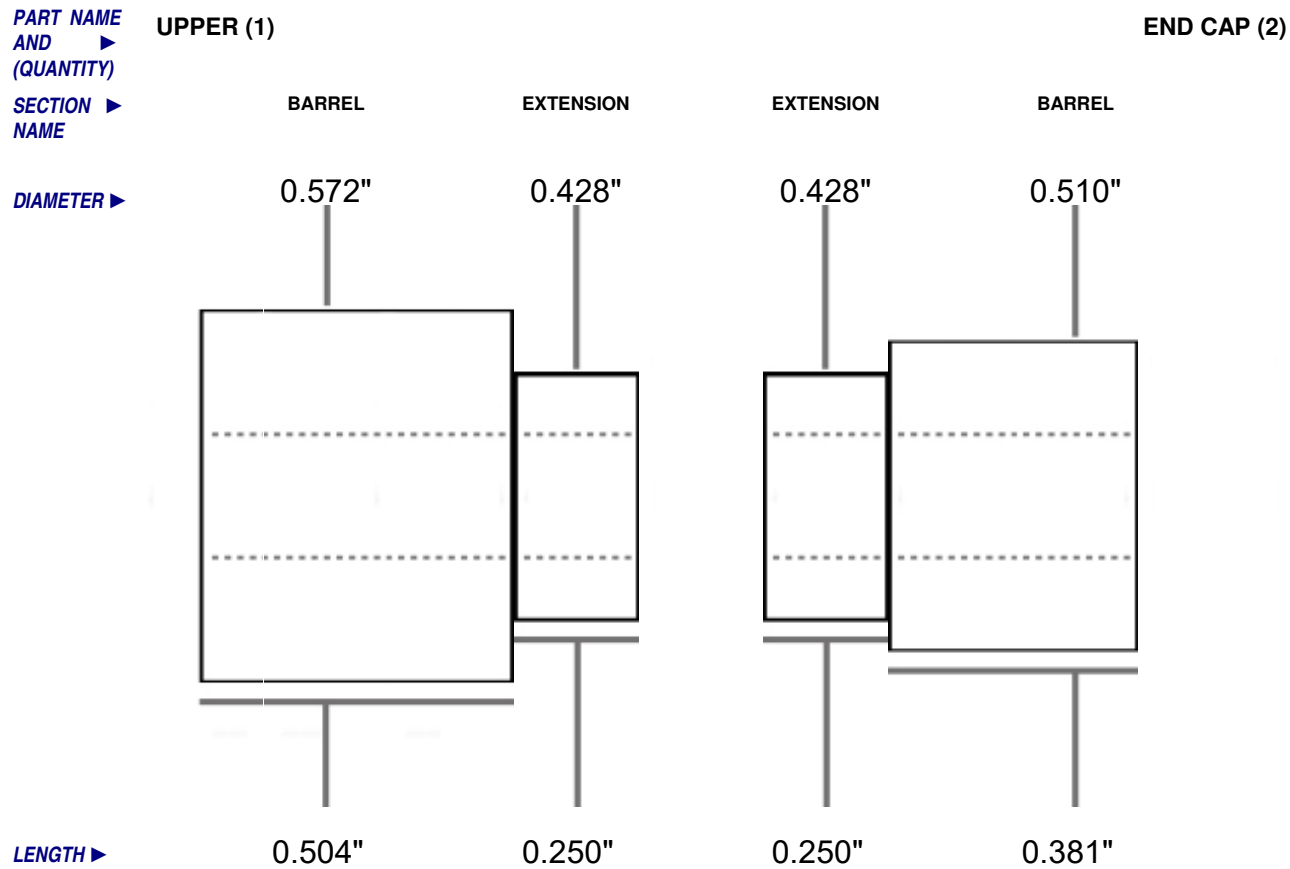

**ASSOCIATED BS15(XX)
KITS:**

PICTURE IS AN APPROXIMATE REPRESENTATION. NOT TO EXACT SCALE OR PROPORTION. ALL MEASUREMENTS IN INCHES. BUSHING DIAMETERS (TOP ROW) ARE OPTIMAL AND SHOULD VARY BY NO MORE THAN .002" WHEN NEW.

ID NUMBER BS25XBU

TYPE: BUSHING

NOTES: END BUSHINGS ARE SAME MEASUREMENTS

NUMBER OF PARTS 3

THRU HOLE STANDARD (0.248')

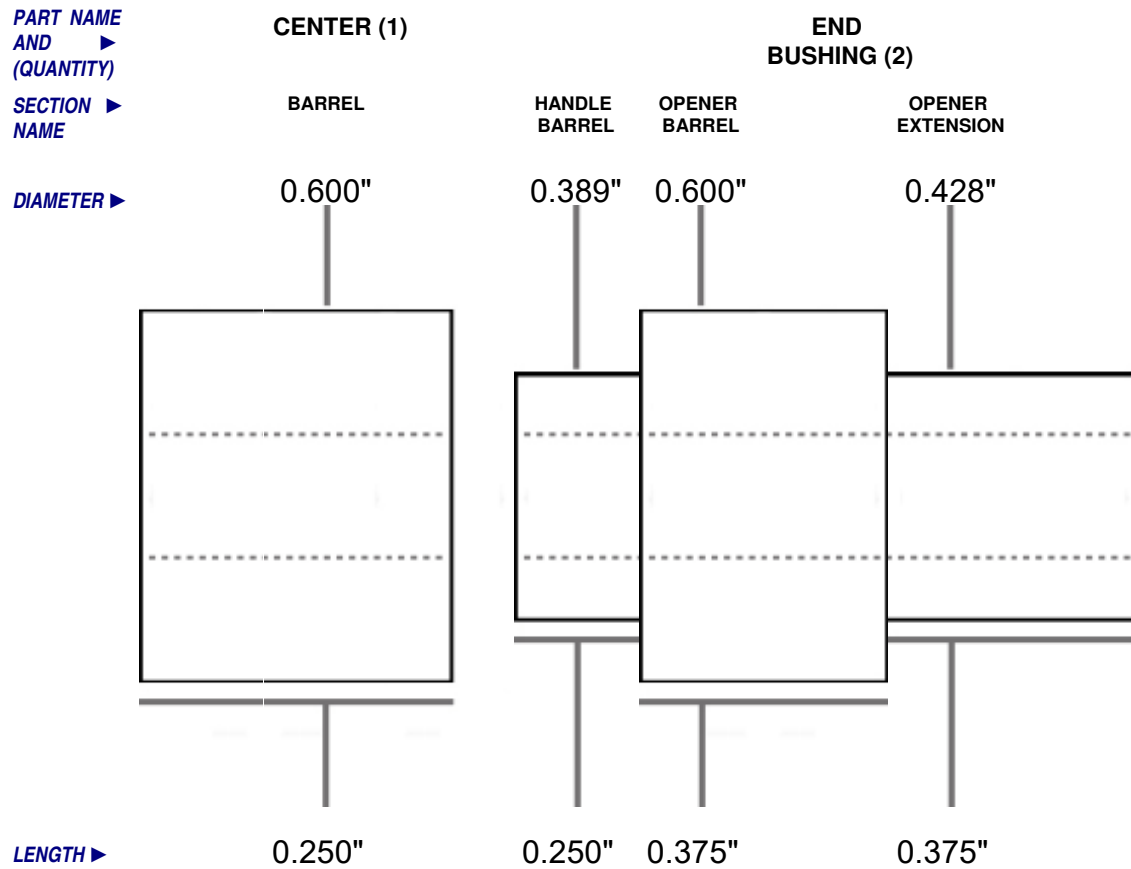

ASSOCIATED BS25X(XX)

KITS:

PICTURE IS AN APPROXIMATE REPRESENTATION. NOT TO EXACT SCALE OR PROPORTION. ALL MEASUREMENTS IN INCHES. BUSHING DIAMETERS (TOP ROW) ARE OPTIMAL AND SHOULD VARY BY NO MORE THAN .002" WHEN NEW.

ID NUMBER BS6-BU

TYPE: BUSHING

NOTES: END BUSHINGS SAME DIMENSION

NUMBER OF PARTS 3

THRU HOLE STANDARD(0.248")

PART NAME AND (QUANTITY)

END (2)

CENTER (1)

SECTION NAME

BARREL

BARREL

DIAMETER

0.390"

0.600"

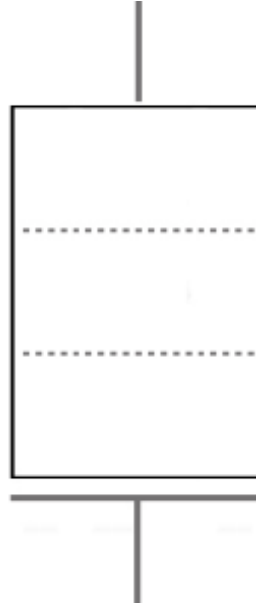

LENGTH

0.450"

0.400"

ASSOCIATED BS6(XX), BS7(XX)

KITS:

PICTURE IS AN APPROXIMATE REPRESENTATION. NOT TO EXACT SCALE OR PROPORTION. ALL MEASUREMENTS IN INCHES. BUSHING DIAMETERS (TOP ROW) ARE OPTIMAL AND SHOULD VARY BY NO MORE THAN .002" WHEN NEW.

ID NUMBER BSLEDBU

TYPE: BUSHING

NOTES:

NUMBER OF PARTS 2

THRU HOLE STANDARD (0.248')

PART NAME AND (QUANTITY)

SECTION NAME

DIAMETER

LENGTH

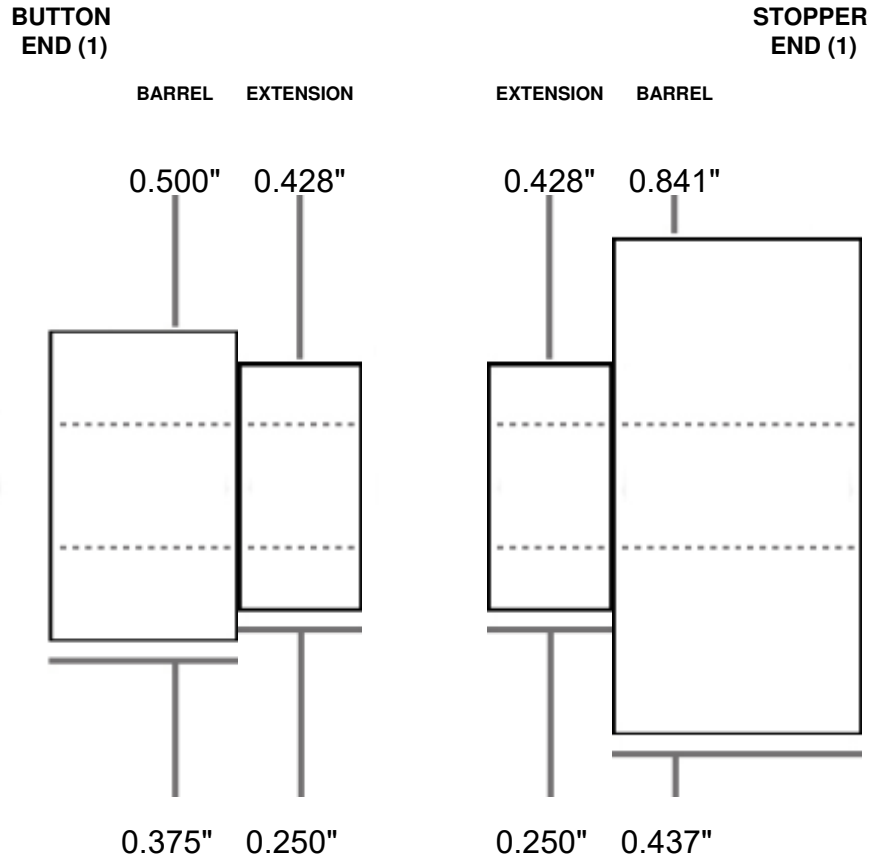

ASSOCIATED BSLED(XX)

KITS:

PICTURE IS AN APPROXIMATE REPRESENTATION. NOT TO EXACT SCALE OR PROPORTION. ALL MEASUREMENTS IN INCHES. BUSHING DIAMETERS (TOP ROW) ARE OPTIMAL AND SHOULD VARY BY NO MORE THAN .002" WHEN NEW.

**ID NUMBER KSEG-M
NUMBER OF PARTS 2**

TYPE: BUSHING

NOTES: BOTH BUSHINGS SAME DIMENSION

THRU HOLE STANDARD(0.248")

**PART NAME AND (QUANTITY)
SECTION NAME
DIAMETER**

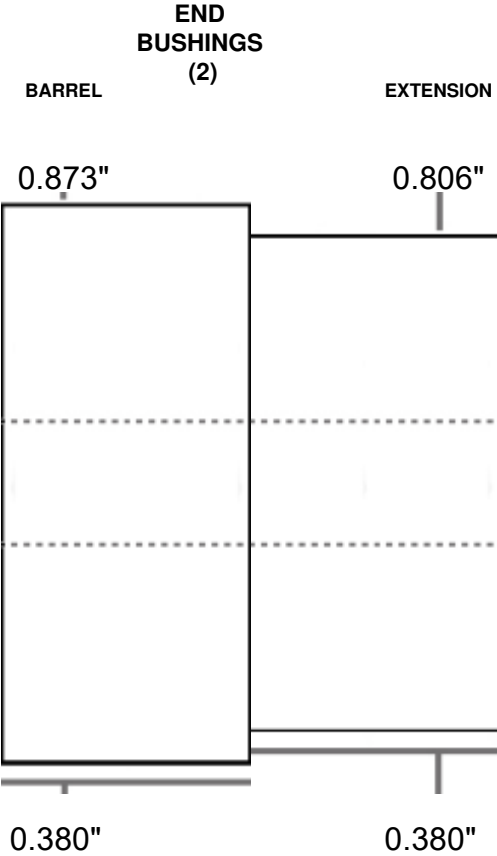

LENGTH

**ASSOCIATED KSEG(XX), KSWAND(XX)
KITS:**

PICTURE IS AN APPROXIMATE REPRESENTATION. NOT TO EXACT SCALE OR PROPORTION. ALL MEASUREMENTS IN INCHES. BUSHING DIAMETERS (TOP ROW) ARE OPTIMAL AND SHOULD VARY BY NO MORE THAN .002" WHEN NEW.

ID NUMBER KSNECBU

TYPE: BUSHING

NOTES:

NUMBER OF PARTS 2

THRU HOLE STANDARD (0.248')

PART NAME AND (QUANTITY)

SECTION NAME

DIAMETER

END BUSHING (2)
BARREL EXTENSION

0.592" 0.460"

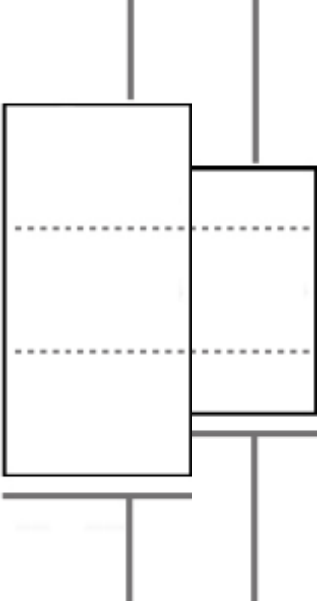

LENGTH

0.460" 0.250"

ASSOCIATED KITS:

PICTURE IS AN APPROXIMATE REPRESENTATION. NOT TO EXACT SCALE OR PROPORTION. ALL MEASUREMENTS IN INCHES. BUSHING DIAMETERS (TOP ROW) ARE OPTIMAL AND SHOULD VARY BY NO MORE THAN .002" WHEN NEW.

ID NUMBER PK10-BUSH3 **TYPE:** BUSHING

NOTES: CAP AND TIP HAVE SAME DIMENSIONS

NUMBER OF PARTS 3

THRU HOLE STANDARD(0.248")

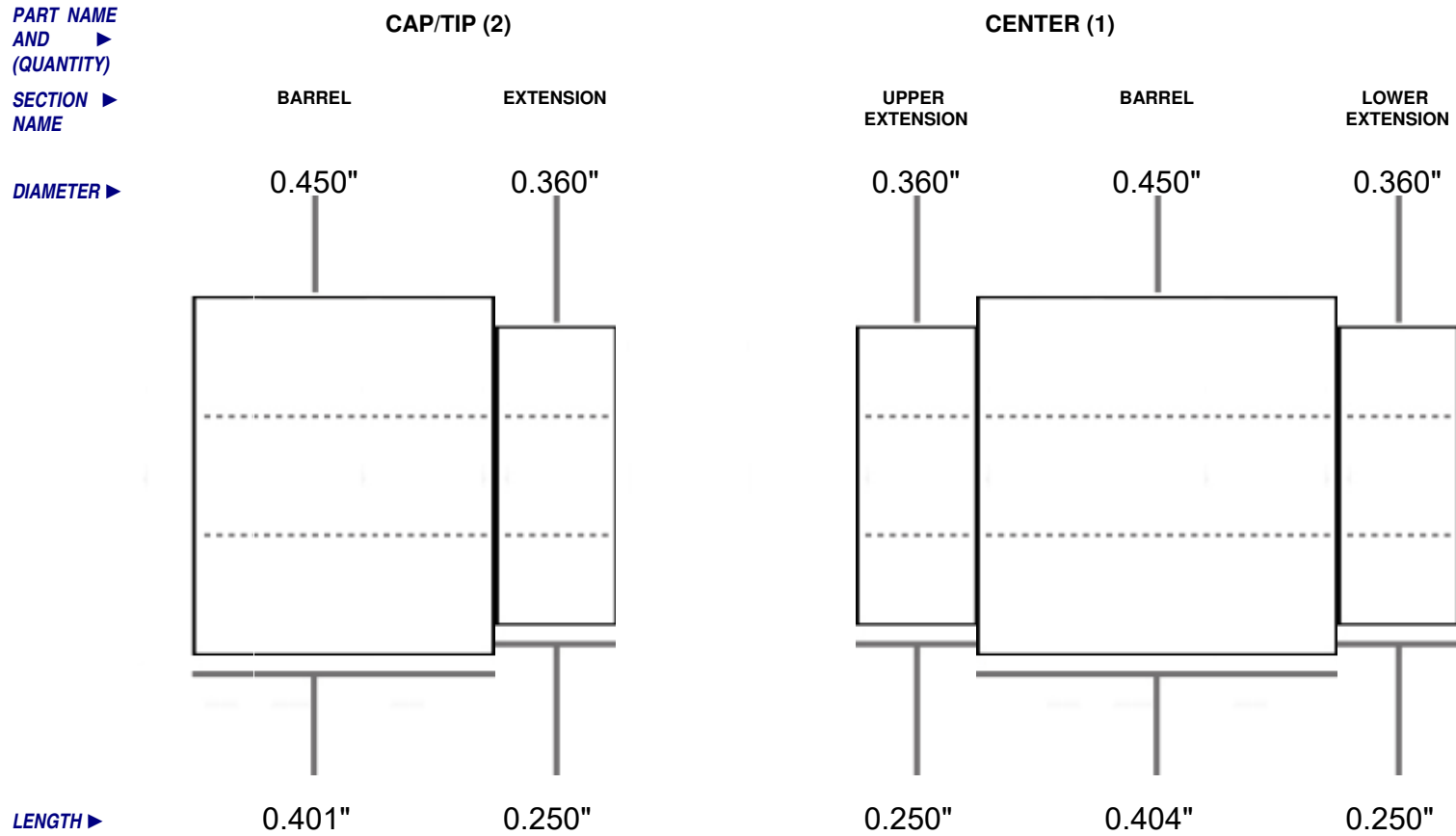

ASSOCIATED KITS: PK10-FP2(XX), PK10-RP2(XX), PKDVN(XX), PKSECRET(XX), PKSEWHIST(XX), PKTOOL(XX), PKTOP2(XX), PKYOYO(XX)

PICTURE IS AN APPROXIMATE REPRESENTATION. NOT TO EXACT SCALE OR PROPORTION. ALL MEASUREMENTS IN INCHES. BUSHING DIAMETERS (TOP ROW) ARE OPTIMAL AND SHOULD VARY BY NO MORE THAN .002" WHEN NEW.

ID NUMBER PK50BABU **TYPE:** BUSHING

NUMBER OF PARTS 3

THRU HOLE STANDARD (0.248")

NOTES: TIP BUSHING AND SMALLER SIDE OF CENTER BUSHING ARE NOT USED FOR TURNING IF USING PRE-MADE BULLET TIP. LARGER SIDE OF CENTER BUSHING IS FOR THE BASE (WIDER) END OF TIP AND THE FRONT (TIP SIDE) END OF THE TURNED CARTRIDGE SECTION.

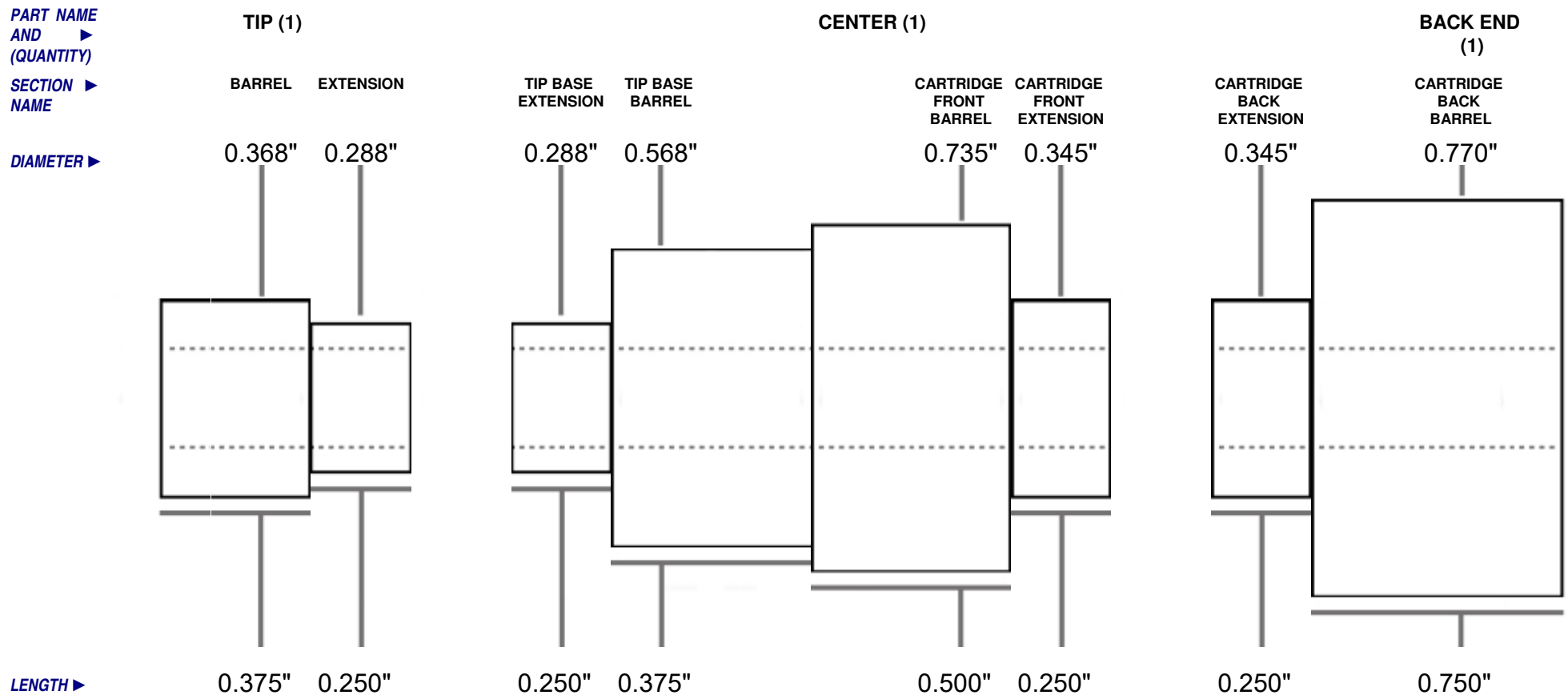

ASSOCIATED PK50BA(XX), PK50BA(XX)2
KITS:

PICTURE IS AN APPROXIMATE REPRESENTATION. NOT TO EXACT SCALE OR PROPORTION. ALL MEASUREMENTS IN INCHES. BUSHING DIAMETERS (TOP ROW) ARE OPTIMAL AND SHOULD VARY BY NO MORE THAN .002" WHEN NEW.

ID NUMBER PK50CALBU

TYPE: BUSHING

NOTES:

NUMBER OF PARTS 2

THRU HOLE CENTER BUSHING THRU HOLE IS .277 TO FIT OVER 7MM TUBE. TIP IS STANDARD(0.248)

PART NAME AND (QUANTITY)

CENTER (1)

TIP (1)

SECTION NAME

BARREL

BARREL

DIAMETER

0.571"

0.369"

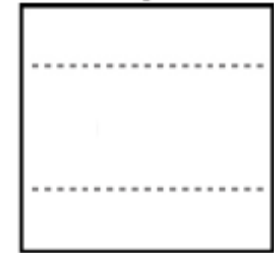
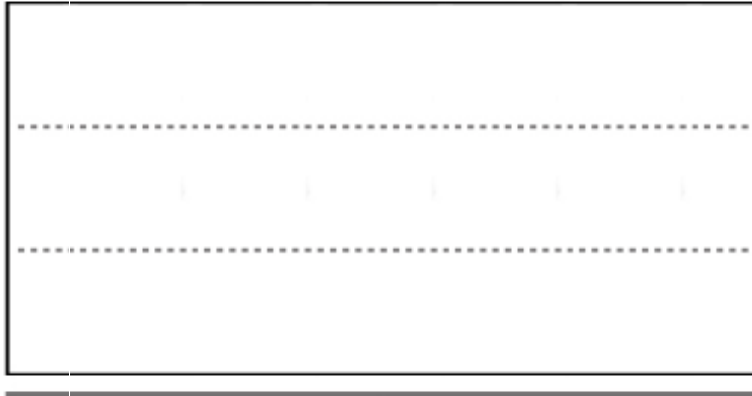

LENGTH

1.500"

0.375"

ASSOCIATED PK50CAL(XX), PK50CALBS(XX)

KITS:

PICTURE IS AN APPROXIMATE REPRESENTATION. NOT TO EXACT SCALE OR PROPORTION. ALL MEASUREMENTS IN INCHES. BUSHING DIAMETERS (TOP ROW) ARE OPTIMAL AND SHOULD VARY BY NO MORE THAN .002" WHEN NEW.

ID NUMBER PK50CALPBU **TYPE:** BUSHING

NOTES: END BUSHINGS SAME MEASUREMENT

NUMBER OF PARTS 3

THRU HOLE CENTER BUSHING THRU HOLE IS .304" TO ACCOMMODATE OUTSIDE OF 8MM TUBE. END BUSHING IS STANDARD (.248")

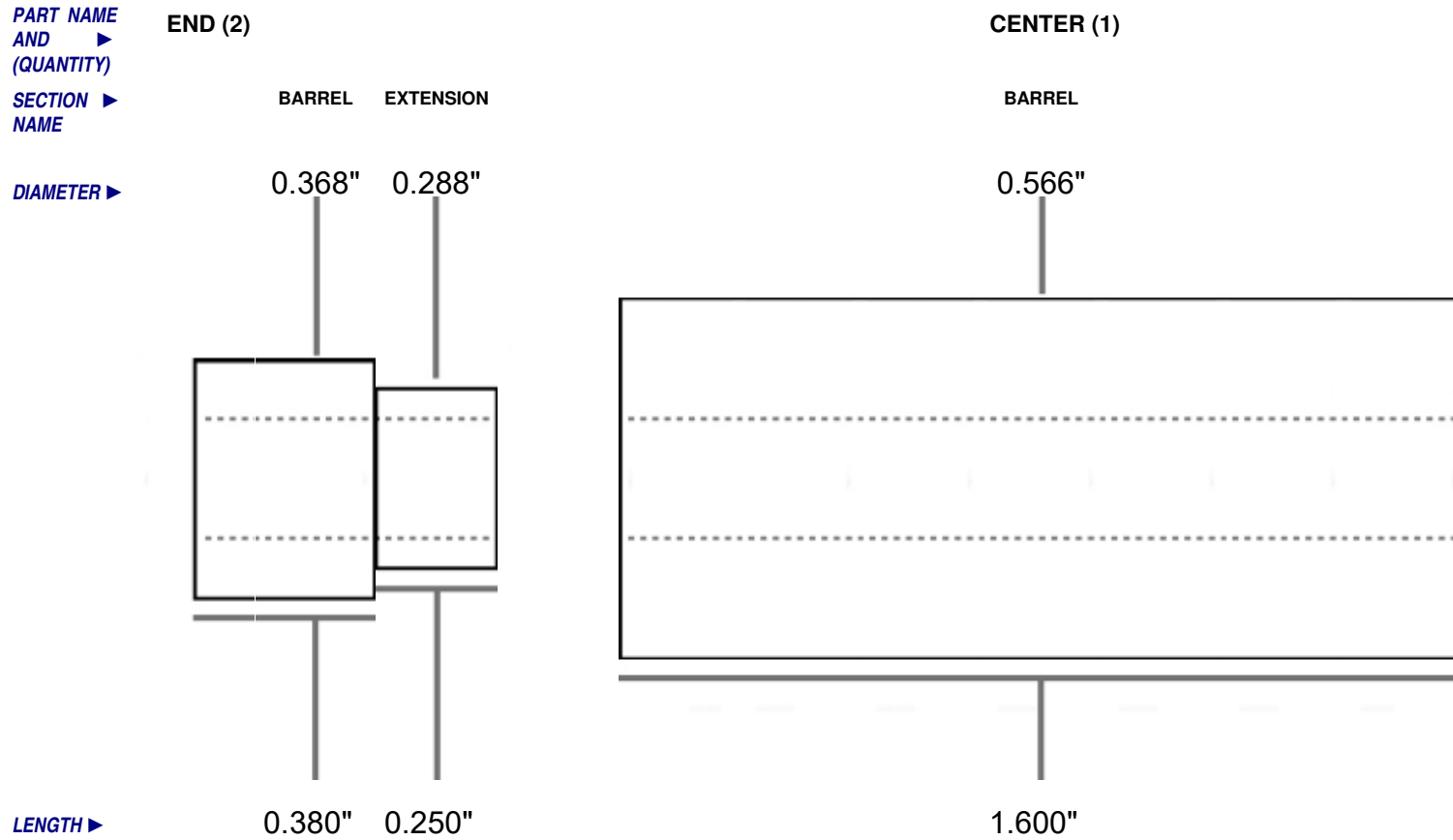

ASSOCIATED PK50CALP(XX)
KITS:

PICTURE IS AN APPROXIMATE REPRESENTATION. NOT TO EXACT SCALE OR PROPORTION. ALL MEASUREMENTS IN INCHES. BUSHING DIAMETERS (TOP ROW) ARE OPTIMAL AND SHOULD VARY BY NO MORE THAN .002" WHEN NEW.

ID NUMBER PK50RBU

TYPE: BUSHING

NOTES: TIP CAP SAME DIMENSION

NUMBER OF PARTS 2

THRU HOLE STANDARD(0.248")

PART NAME AND (QUANTITY)

SECTION NAME

DIAMETER

LENGTH

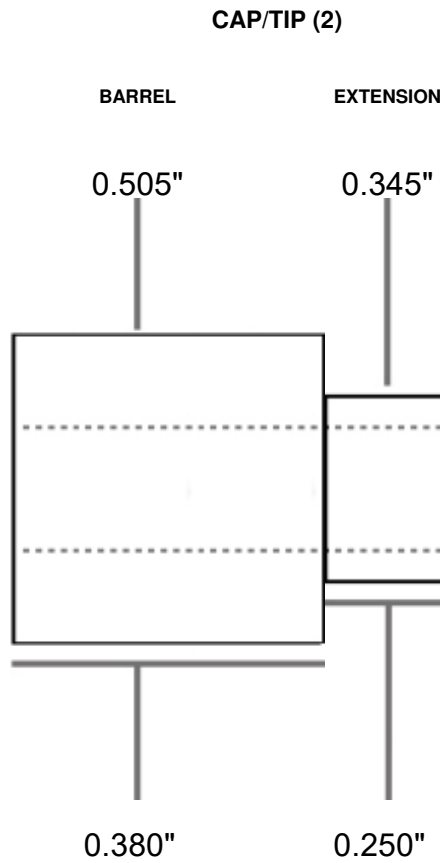

ASSOCIATED PK50BPX(XX), PK50RBX(XX)

KITS:

PICTURE IS AN APPROXIMATE REPRESENTATION. NOT TO EXACT SCALE OR PROPORTION. ALL MEASUREMENTS IN INCHES. BUSHING DIAMETERS (TOP ROW) ARE OPTIMAL AND SHOULD VARY BY NO MORE THAN .002" WHEN NEW.

ID NUMBER PKABBU

TYPE: BUSHING

NOTES: BOTH SIDES SAME MEASUREMENT

NUMBER OF PARTS 2

THRU HOLE STANDARD (0.248')

PART NAME AND (QUANTITY)

SECTION NAME

DIAMETER

LENGTH

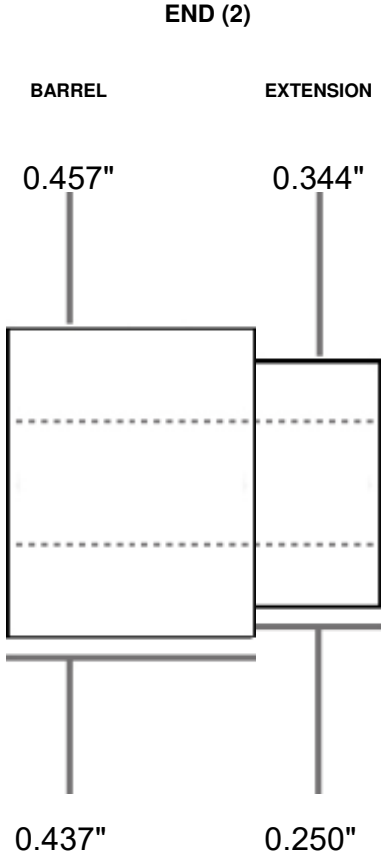

ASSOCIATED PKAB(XX), PKBPNKC(XX), PKHGUN(XX), PKMSCUP(XX) KITS:

PICTURE IS AN APPROXIMATE REPRESENTATION. NOT TO EXACT SCALE OR PROPORTION. ALL MEASUREMENTS IN INCHES. BUSHING DIAMETERS (TOP ROW) ARE OPTIMAL AND SHOULD VARY BY NO MORE THAN .002" WHEN NEW.

ID NUMBER PKANVBU

TYPE: BUSHING

NOTES:

NUMBER OF PARTS 2

THRU HOLE STANDARD (0.248')

PART NAME AND (QUANTITY)

SECTION NAME

DIAMETER

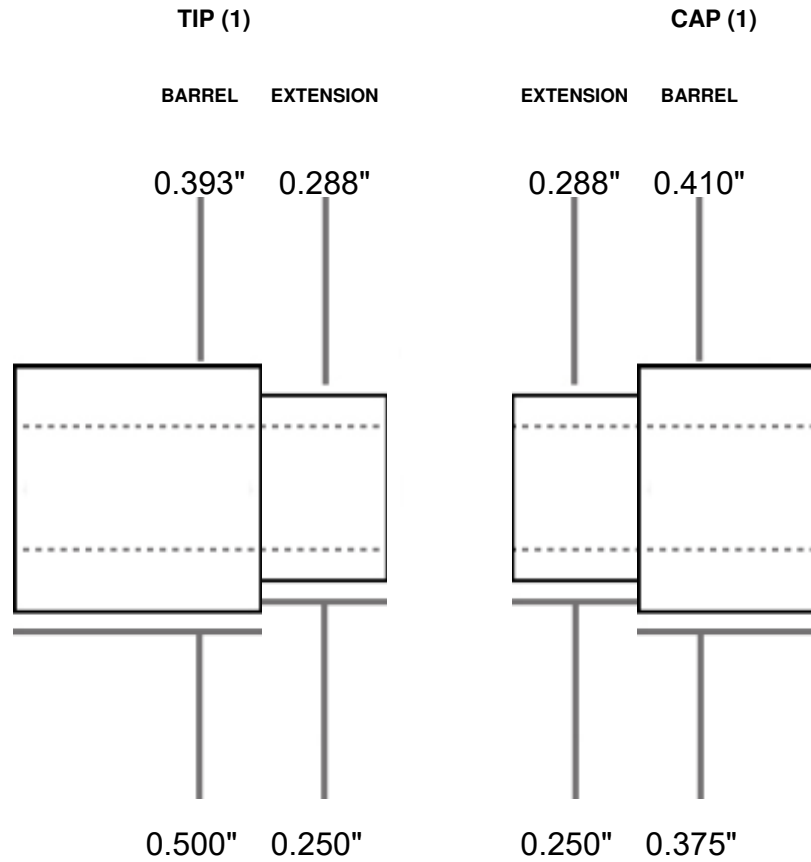

LENGTH

ASSOCIATED PKANV(XX), PKANVX(XX)

KITS:

PICTURE IS AN APPROXIMATE REPRESENTATION. NOT TO EXACT SCALE OR PROPORTION. ALL MEASUREMENTS IN INCHES. BUSHING DIAMETERS (TOP ROW) ARE OPTIMAL AND SHOULD VARY BY NO MORE THAN .002" WHEN NEW.

ID NUMBER PKAPBBU

TYPE: BUSHING

NOTES:

NUMBER OF PARTS 3

THRU HOLE STANDARD (0.248')

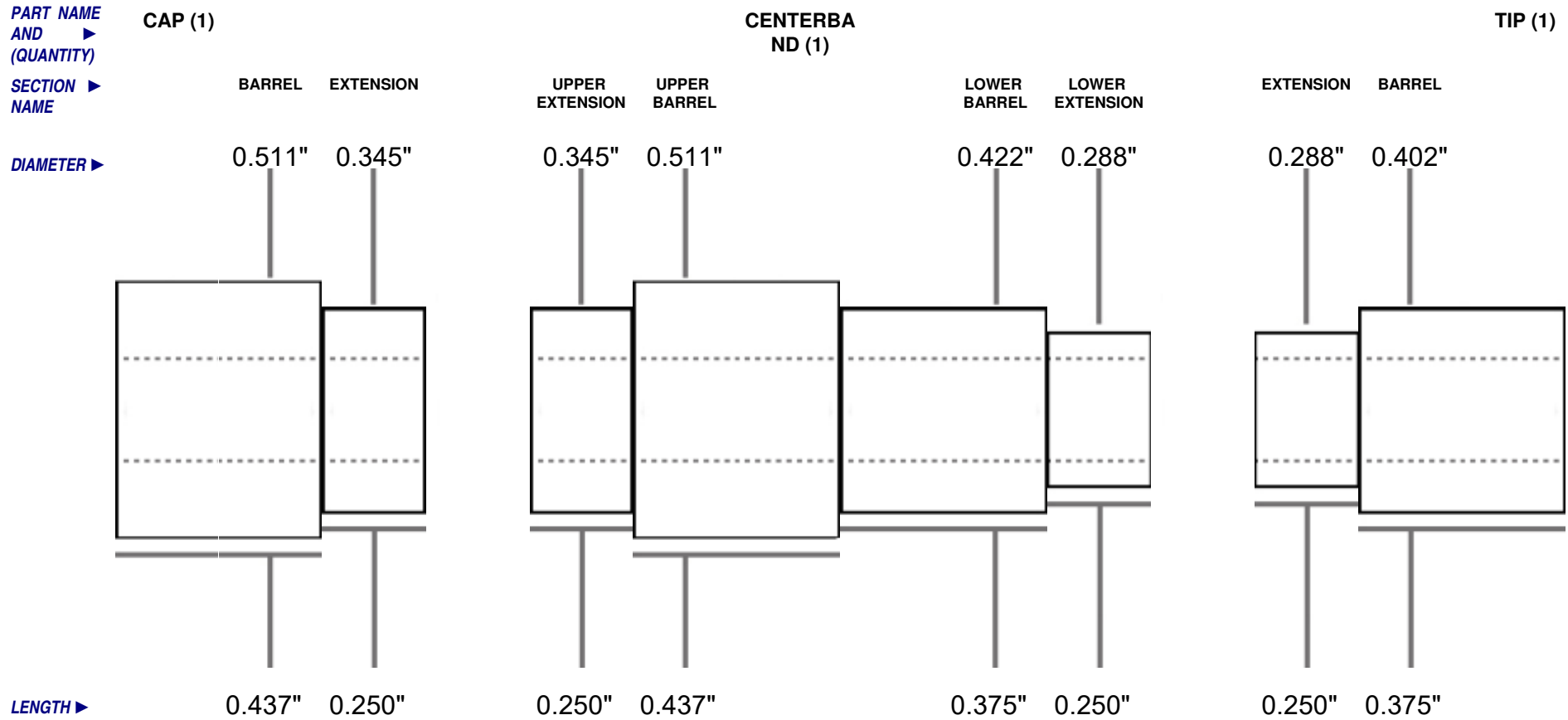

ASSOCIATED PKAPB(XX)

KITS:

PICTURE IS AN APPROXIMATE REPRESENTATION. NOT TO EXACT SCALE OR PROPORTION. ALL MEASUREMENTS IN INCHES. BUSHING DIAMETERS (TOP ROW) ARE OPTIMAL AND SHOULD VARY BY NO MORE THAN .002" WHEN NEW.

ID NUMBER PKAPBTS
NUMBER OF PARTS 2

TYPE: TRIMMING SLEEVE

NOTES: FITS STANDARD TUBES SIZED 9/16" (UPPER) AND 12.5MM (LOWER)

THRU HOLE ACCEPTS 7MM TRIMMER SHAFT

PART NAME AND (QUANTITY)

UPPER BARREL (1)

LOWER BARREL (1)

SECTION NAME

BARREL

BARREL

DIAMETER

0.534"

0.454"

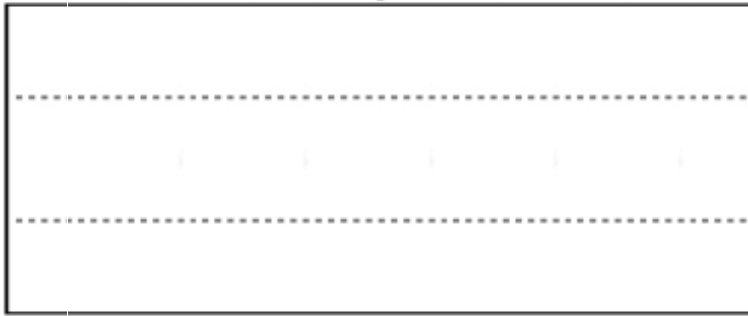

LENGTH

1.563"

2.000"

ASSOCIATED KITS:

PICTURE IS AN APPROXIMATE REPRESENTATION. NOT TO EXACT SCALE OR PROPORTION. ALL MEASUREMENTS IN INCHES. BUSHING DIAMETERS (TOP ROW) ARE OPTIMAL AND SHOULD VARY BY NO MORE THAN .002" WHEN NEW.

ID NUMBER PKAPCEBU **TYPE:** BUSHING

NOTES: PART OF CLOSED END SYSTEM. ONLY ONE BUSHING IS USED ON EACH BLANK

NUMBER OF PARTS 2

THRU HOLE STANDARD (0.248')

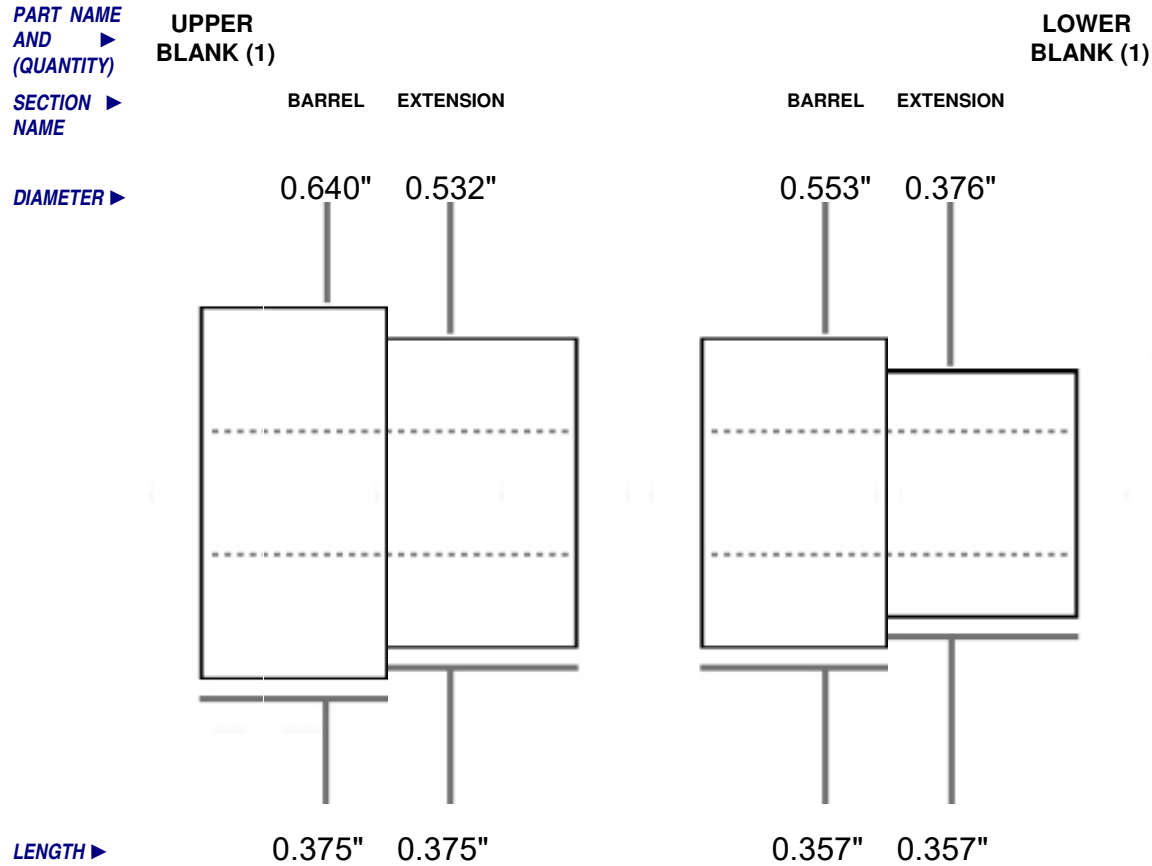

ASSOCIATED PKAPCF(XX), PKAPCR(XX)
KITS:

PICTURE IS AN APPROXIMATE REPRESENTATION. NOT TO EXACT SCALE OR PROPORTION. ALL MEASUREMENTS IN INCHES. BUSHING DIAMETERS (TOP ROW) ARE OPTIMAL AND SHOULD VARY BY NO MORE THAN .002" WHEN NEW.

ID NUMBER PKAPFILBU **TYPE:** BUSHING

NOTES:

NUMBER OF PARTS 3

THRU HOLE STANDARD (0.248')

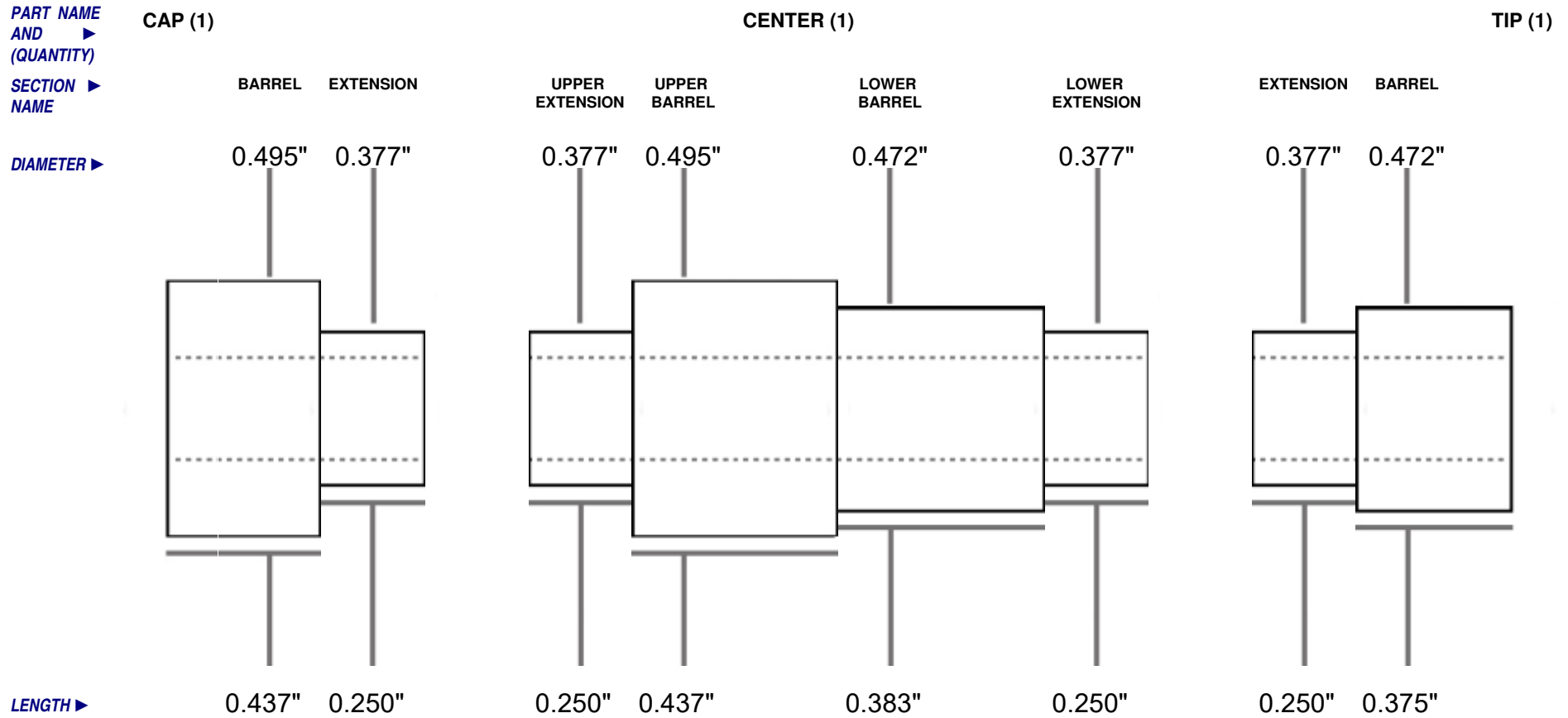

ASSOCIATED PKAPFIL(XX)
KITS:

PICTURE IS AN APPROXIMATE REPRESENTATION. NOT TO EXACT SCALE OR PROPORTION. ALL MEASUREMENTS IN INCHES. BUSHING DIAMETERS (TOP ROW) ARE OPTIMAL AND SHOULD VARY BY NO MORE THAN .002" WHEN NEW.

ID NUMBER PKAPR2BU

TYPE: BUSHING

NOTES:

NUMBER OF PARTS 3

THRU HOLE STANDARD(0.248")

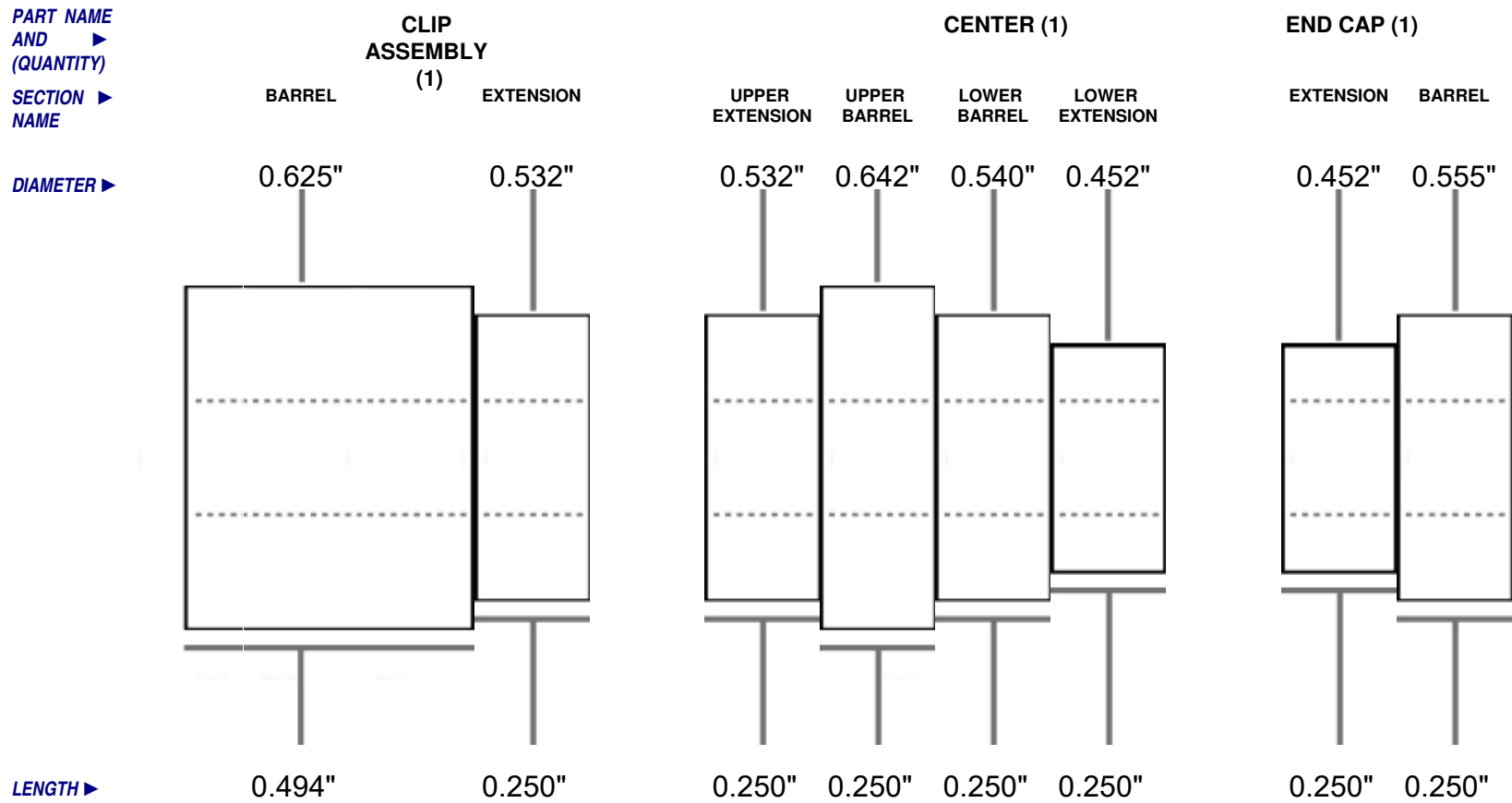

ASSOCIATED PKAPFP2(XX), PKAPRB2(XX)

KITS:

PICTURE IS AN APPROXIMATE REPRESENTATION. NOT TO EXACT SCALE OR PROPORTION. ALL MEASUREMENTS IN INCHES. BUSHING DIAMETERS (TOP ROW) ARE OPTIMAL AND SHOULD VARY BY NO MORE THAN .002" WHEN NEW.

ID NUMBER PKARTBU

TYPE: BUSHING

NOTES:

NUMBER OF PARTS 3

THRU HOLE STANDARD(0.248")

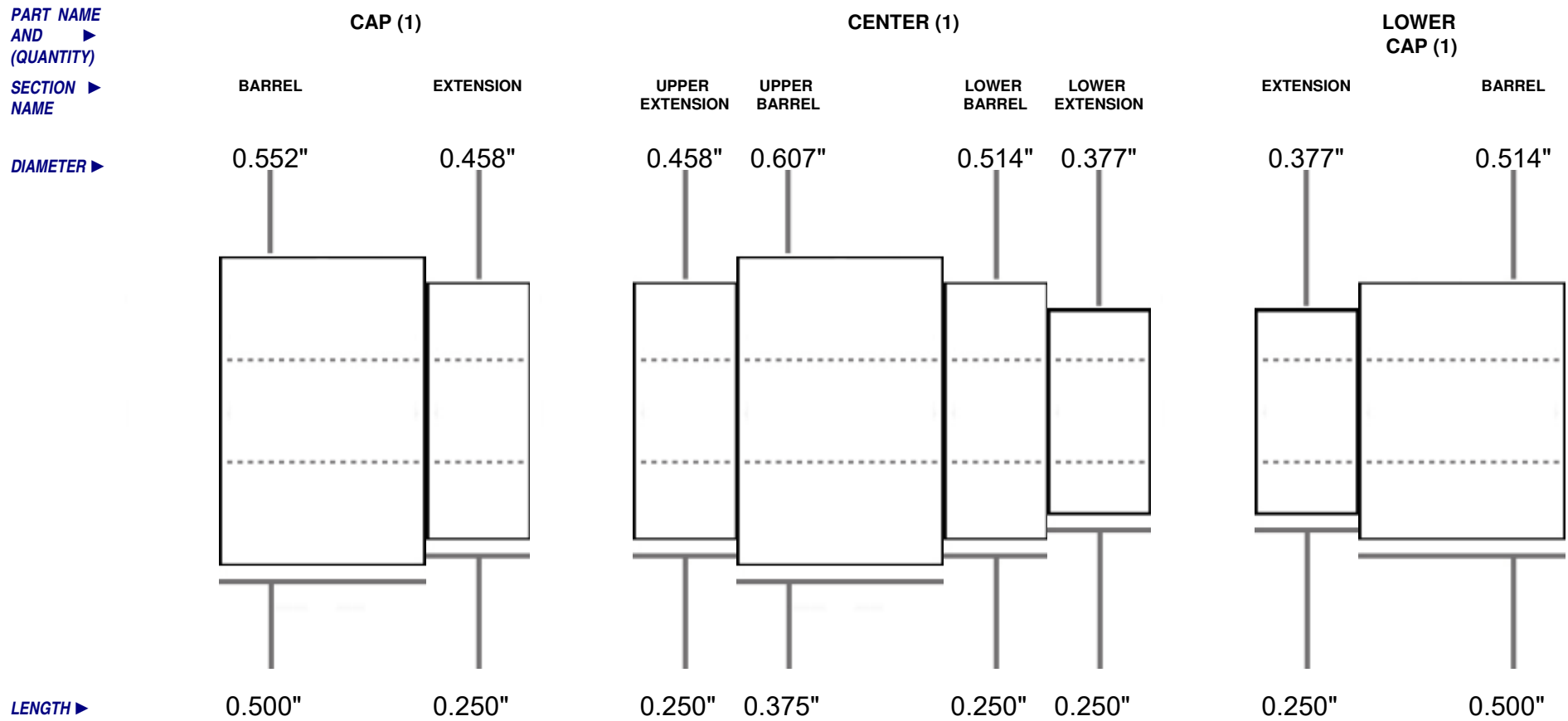

ASSOCIATED KITS: PKART(XX)F, PKART(XX)R

PICTURE IS AN APPROXIMATE REPRESENTATION. NOT TO EXACT SCALE OR PROPORTION. ALL MEASUREMENTS IN INCHES. BUSHING DIAMETERS (TOP ROW) ARE OPTIMAL AND SHOULD VARY BY NO MORE THAN .002" WHEN NEW.

ID NUMBER PKATHNBU **TYPE:** BUSHING

NOTES: BOTH SIDES SAME DIMENSION

NUMBER OF PARTS 2

THRU HOLE STANDARD (0.248')

PART NAME AND (QUANTITY)

SECTION NAME

DIAMETER

LENGTH

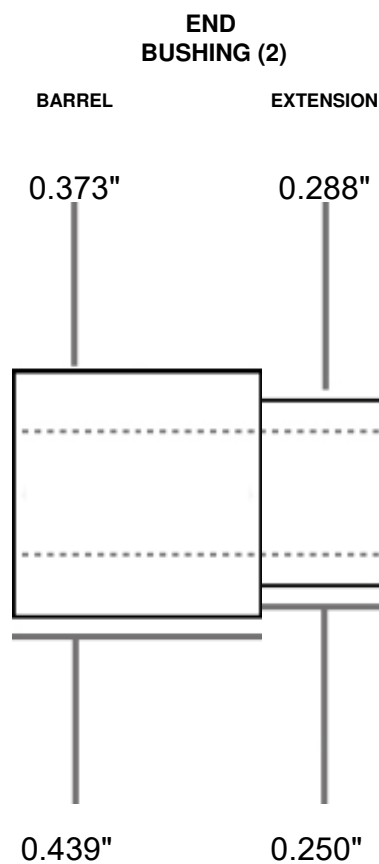

ASSOCIATED KITS: PKATHN(XX), PKAUX(XX), PK-WHIST(XX)

PICTURE IS AN APPROXIMATE REPRESENTATION. NOT TO EXACT SCALE OR PROPORTION. ALL MEASUREMENTS IN INCHES. BUSHING DIAMETERS (TOP ROW) ARE OPTIMAL AND SHOULD VARY BY NO MORE THAN .002" WHEN NEW.

ID NUMBER PKATOM-BU **TYPE:** BUSHING

NOTES: END BUSHINGS ARE THE SAME DIMENSION

NUMBER OF PARTS 3

THRU HOLE STANDARD(0.248")

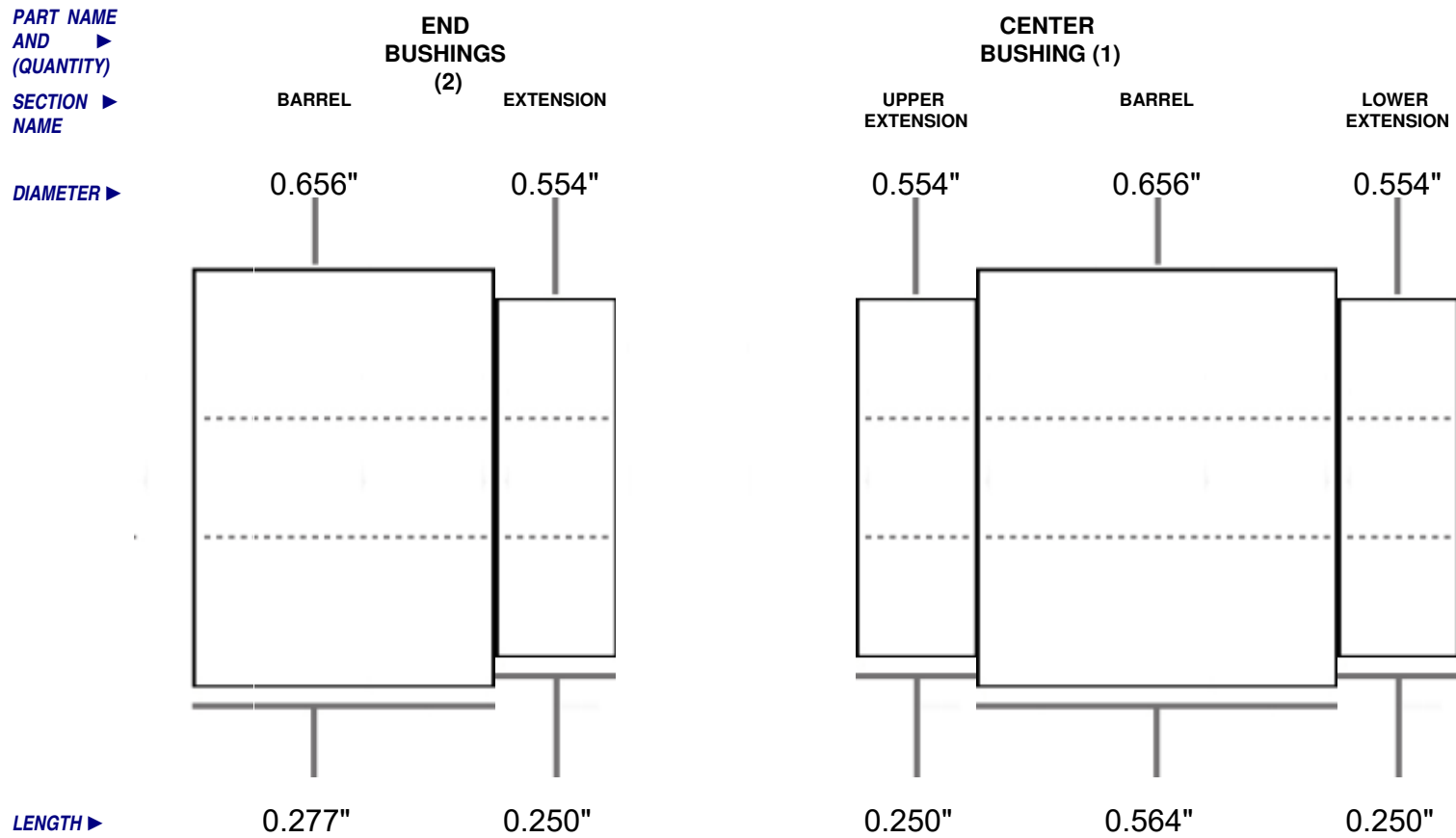

ASSOCIATED PKATOM(XX), PKATOM2(XX)
KITS:

PICTURE IS AN APPROXIMATE REPRESENTATION. NOT TO EXACT SCALE OR PROPORTION. ALL MEASUREMENTS IN INCHES. BUSHING DIAMETERS (TOP ROW) ARE OPTIMAL AND SHOULD VARY BY NO MORE THAN .002" WHEN NEW.

ID NUMBER PKATOMKCBU **TYPE:** BUSHING
NUMBER OF PARTS 3

NOTES: BARREL TRIMMER COMES WITH BUSHINGS. END BUSHINGS ARE SAME MEASUREMENT

THRU HOLE STANDARD (0.248") ON BUSHINGS, .355" ON BARREL TRIMMING SLEEVE

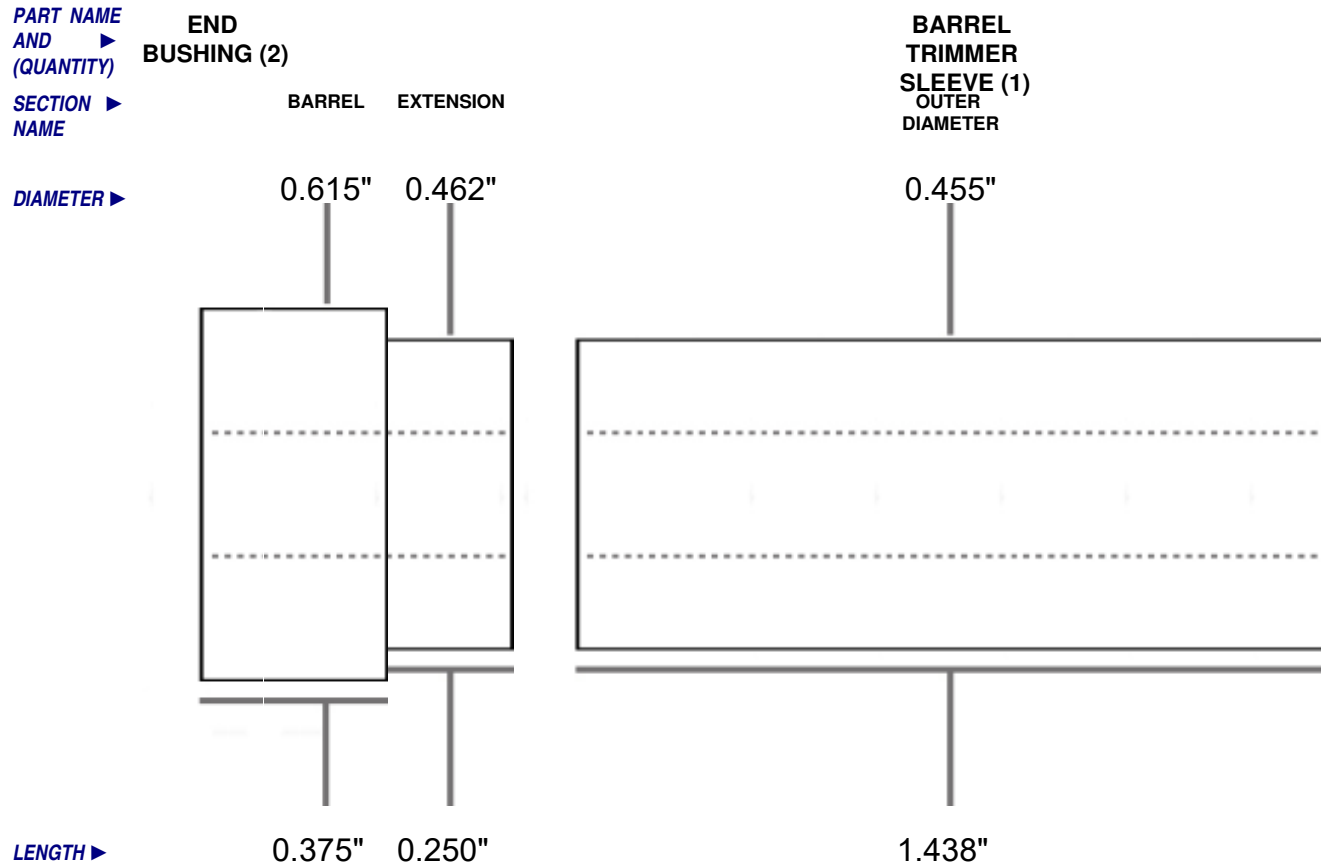

ASSOCIATED PKATOMKC(XX)
KITS:

PICTURE IS AN APPROXIMATE REPRESENTATION. NOT TO EXACT SCALE OR PROPORTION. ALL MEASUREMENTS IN INCHES. BUSHING DIAMETERS (TOP ROW) ARE OPTIMAL AND SHOULD VARY BY NO MORE THAN .002" WHEN NEW.

ID NUMBER PKAUTOBU **TYPE:** BUSHING

NOTES: BOTH BUSHINGS SAME DIMENSIONS

NUMBER OF PARTS 2

THRU HOLE STANDARD (0.248')

PART NAME AND (QUANTITY)

SECTION NAME

DIAMETER

LENGTH

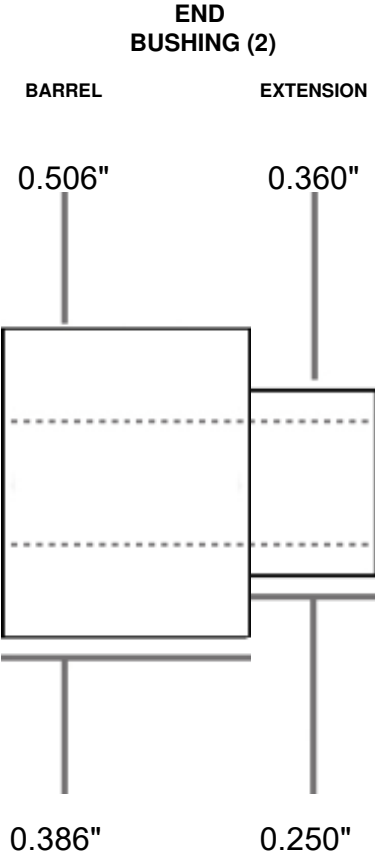

ASSOCIATED PKAUTO(XX)
KITS:

PICTURE IS AN APPROXIMATE REPRESENTATION. NOT TO EXACT SCALE OR PROPORTION. ALL MEASUREMENTS IN INCHES. BUSHING DIAMETERS (TOP ROW) ARE OPTIMAL AND SHOULD VARY BY NO MORE THAN .002" WHEN NEW.

ID NUMBER PKBASEBU **TYPE:** BUSHING

NOTES:

NUMBER OF PARTS 2

THRU HOLE STANDARD (0.248')

PART NAME AND (QUANTITY)

SECTION NAME

DIAMETER

LENGTH

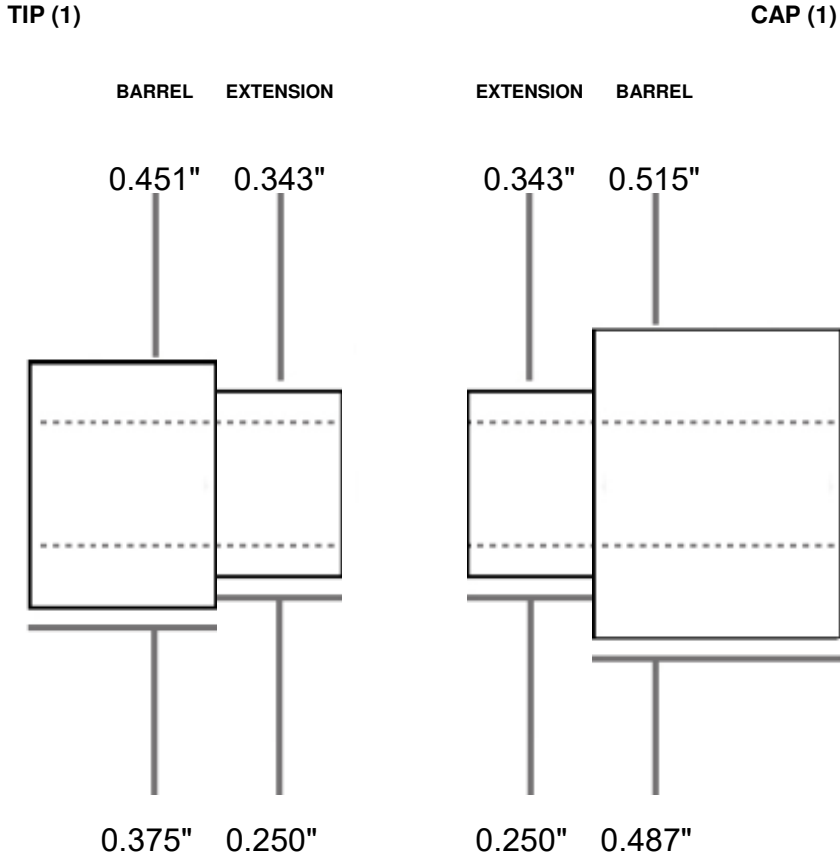

ASSOCIATED PKBASE(XX)
KITS:

PICTURE IS AN APPROXIMATE REPRESENTATION. NOT TO EXACT SCALE OR PROPORTION. ALL MEASUREMENTS IN INCHES. BUSHING DIAMETERS (TOP ROW) ARE OPTIMAL AND SHOULD VARY BY NO MORE THAN .002" WHEN NEW.

ID NUMBER PKBCMBU

TYPE: BUSHING

NOTES:

NUMBER OF PARTS 3

THRU HOLE STANDARD (0.248')

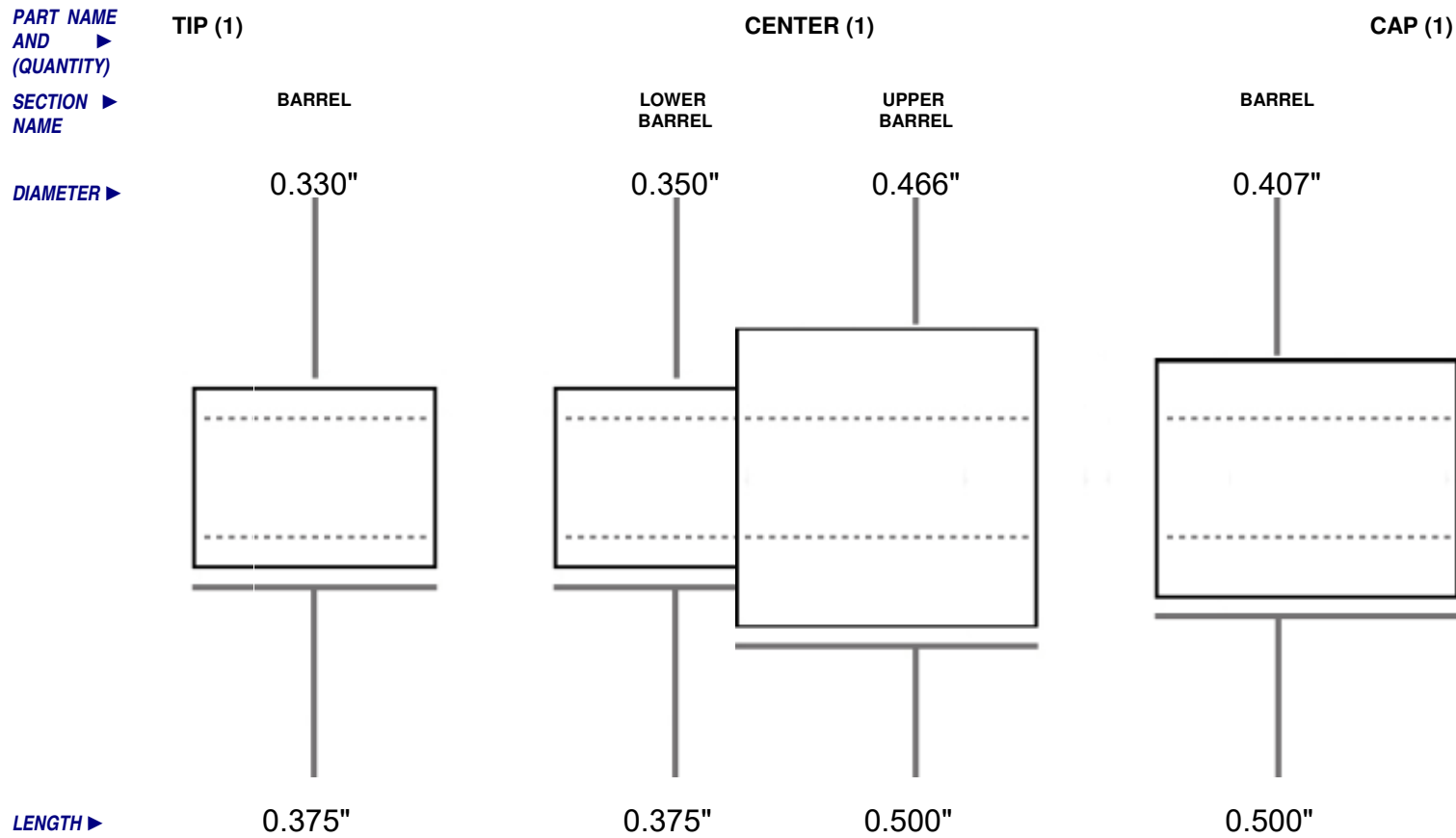

ASSOCIATED PKBCM(XX)

KITS:

PICTURE IS AN APPROXIMATE REPRESENTATION. NOT TO EXACT SCALE OR PROPORTION. ALL MEASUREMENTS IN INCHES. BUSHING DIAMETERS (TOP ROW) ARE OPTIMAL AND SHOULD VARY BY NO MORE THAN .002" WHEN NEW.

ID NUMBER PKBCPBU

TYPE: BUSHING

NOTES:

NUMBER OF PARTS 3

THRU HOLE STANDARD(0.248")

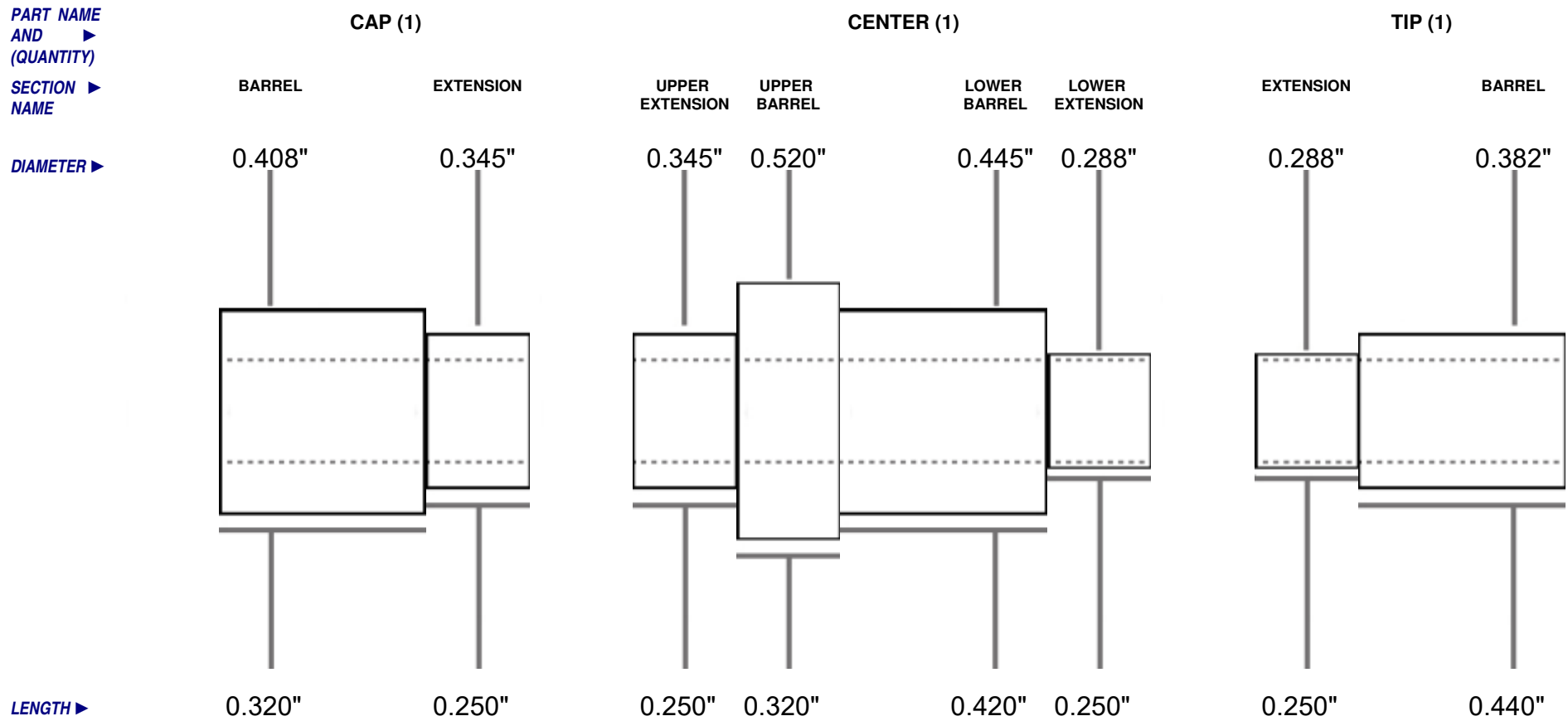

ASSOCIATED PKBCP(XX), PKBLPEN(XX)

KITS:

PICTURE IS AN APPROXIMATE REPRESENTATION. NOT TO EXACT SCALE OR PROPORTION. ALL MEASUREMENTS IN INCHES. BUSHING DIAMETERS (TOP ROW) ARE OPTIMAL AND SHOULD VARY BY NO MORE THAN .002" WHEN NEW.

ID NUMBER PKBEGBU

TYPE: BUSHING

NOTES:

NUMBER OF PARTS 2

THRU HOLE STANDARD (0.248')

PART NAME AND (QUANTITY)

SECTION NAME

DIAMETER

END (2)

BARREL

0.703"

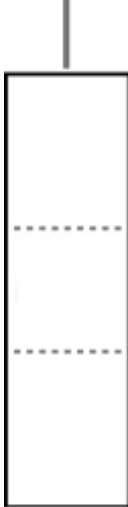

0.250"

LENGTH

ASSOCIATED KITS: PKBEGLERI(XX)

PICTURE IS AN APPROXIMATE REPRESENTATION. NOT TO EXACT SCALE OR PROPORTION. ALL MEASUREMENTS IN INCHES. BUSHING DIAMETERS (TOP ROW) ARE OPTIMAL AND SHOULD VARY BY NO MORE THAN .002" WHEN NEW.

ID NUMBER PKBELBU

TYPE: BUSHING

NOTES:

NUMBER OF PARTS 2

THRU HOLE STANDARD (0.248')

PART NAME AND (QUANTITY)

SECTION NAME

DIAMETER

LENGTH

TIP (1)

CAP (1)

BARREL

EXTENSION

EXTENSION

BARREL

0.469"

0.360"

0.360"

0.475"

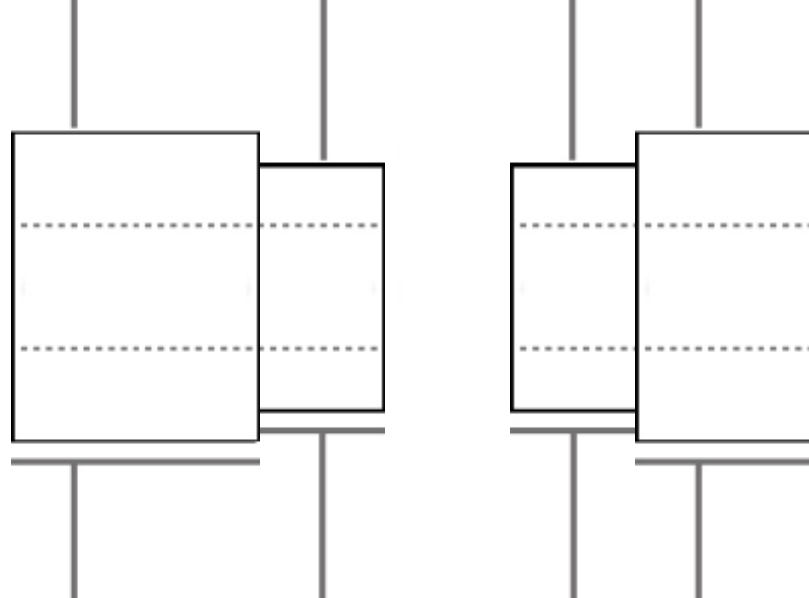

0.487"

0.250"

0.250"

0.375"

ASSOCIATED PKBEL(XX)

KITS:

PICTURE IS AN APPROXIMATE REPRESENTATION. NOT TO EXACT SCALE OR PROPORTION. ALL MEASUREMENTS IN INCHES. BUSHING DIAMETERS (TOP ROW) ARE OPTIMAL AND SHOULD VARY BY NO MORE THAN .002" WHEN NEW.

ID NUMBER PKBHOLDBU **TYPE:** BUSHING

NOTES: END BUSHINGS HAVE SAME DIMENSIONS

NUMBER OF PARTS 3

THRU HOLE STANDARD(0.248")

PART NAME AND (QUANTITY)
SECTION NAME

END BUSHINGS (2)

CENTER BUSHING (1)

BARREL

BARREL

DIAMETER ▶ 0.440"

DIAMETER ▶ 0.490"

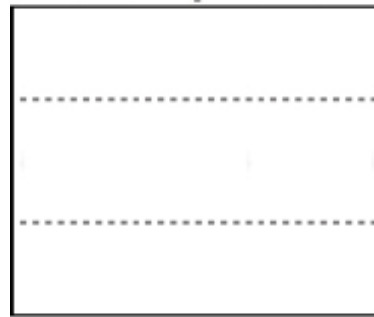
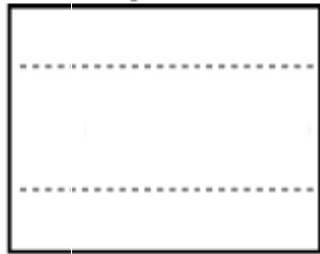

LENGTH ▶

0.375"

0.437"

ASSOCIATED PKBHOLD(XX)

KITS:

PICTURE IS AN APPROXIMATE REPRESENTATION. NOT TO EXACT SCALE OR PROPORTION. ALL MEASUREMENTS IN INCHES. BUSHING DIAMETERS (TOP ROW) ARE OPTIMAL AND SHOULD VARY BY NO MORE THAN .002" WHEN NEW.

ID NUMBER PKBIG-BU

TYPE: BUSHING

NOTES:

NUMBER OF PARTS 3

THRU HOLE STANDARD(0.248")

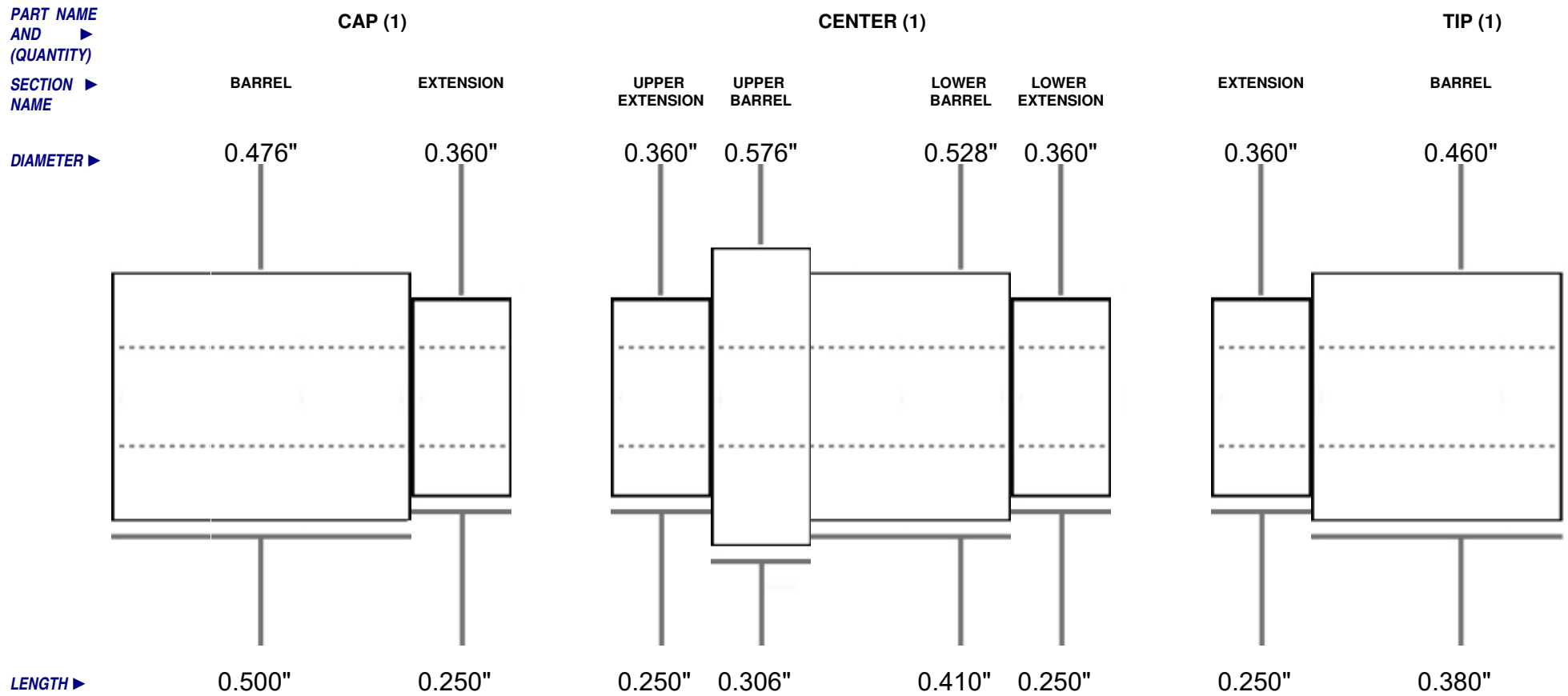

ASSOCIATED PKBIG(XX), PKBIGC(XX), PKBIGCP(XX), PKBIGFP2(XX), PKBIGRP2(XX), PKBIGST(XX), PKBIGTT(XX)

KITS:

PICTURE IS AN APPROXIMATE REPRESENTATION. NOT TO EXACT SCALE OR PROPORTION. ALL MEASUREMENTS IN INCHES. BUSHING DIAMETERS (TOP ROW) ARE OPTIMAL AND SHOULD VARY BY NO MORE THAN .002" WHEN NEW.

ID NUMBER PK-BS1-MJ **TYPE:** CHUCK

NOTES:

NUMBER OF PARTS 1

THRU HOLE NONE. REAR IS THREADED 1"X8TPI

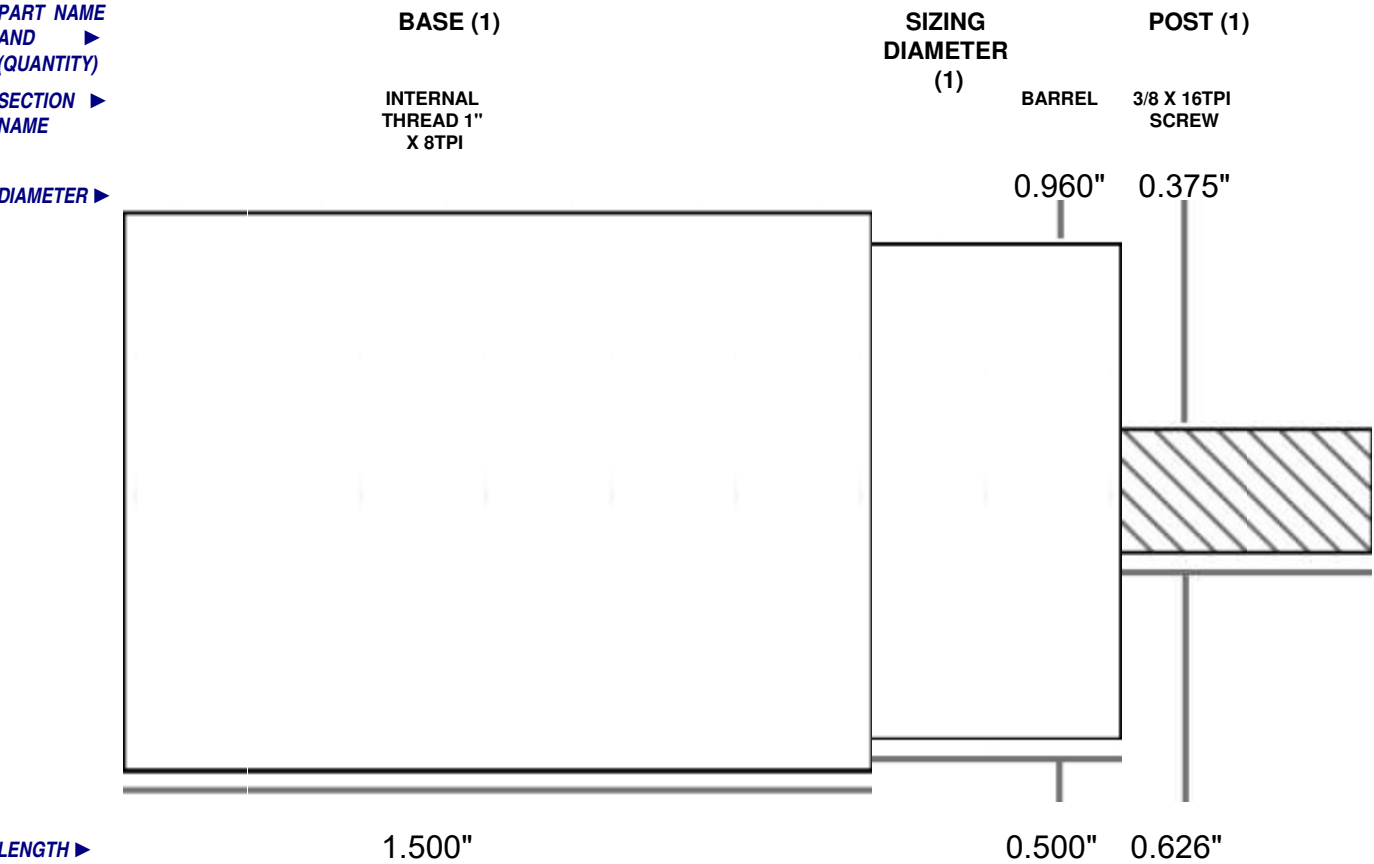

ASSOCIATED KITS: BS1(XX), BS10S(XX), BS12S(XX), BS14S(XX), BS2(XX), BS27(XX), BS3(XX), BS5(XX), BS7LP(XX), BS8(XX), BS9A(XX), PKTAT(XX)

PICTURE IS AN APPROXIMATE REPRESENTATION. NOT TO EXACT SCALE OR PROPORTION. ALL MEASUREMENTS IN INCHES. BUSHING DIAMETERS (TOP ROW) ARE OPTIMAL AND SHOULD VARY BY NO MORE THAN .002" WHEN NEW.

ID NUMBER PKBS28CBU **TYPE:** BUSHING

NOTES: SAME DIMENSION ON ALL 3 PARTS

NUMBER OF PARTS 3

THRU HOLE STANDARD (0.248')

PART NAME AND (QUANTITY)

SECTION NAME

DIAMETER

END BUSHING (3)

BARREL

0.553"

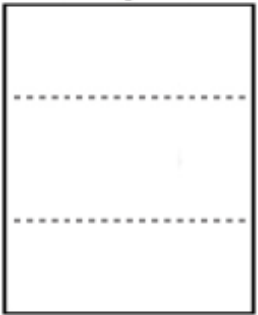

0.500"

LENGTH

ASSOCIATED BS28(XX)
KITS:

PICTURE IS AN APPROXIMATE REPRESENTATION. NOT TO EXACT SCALE OR PROPORTION. ALL MEASUREMENTS IN INCHES. BUSHING DIAMETERS (TOP ROW) ARE OPTIMAL AND SHOULD VARY BY NO MORE THAN .002" WHEN NEW.

ID NUMBER PKBSBU

TYPE: BUSHING

NOTES:

NUMBER OF PARTS 1

THRU HOLE .375"

PART NAME AND (QUANTITY)

SECTION NAME

DIAMETER

LENGTH

CHUCK BUSHING (1)

OUTER DIAMETER

0.800"

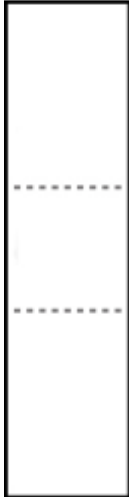

0.210"

ASSOCIATED BSN-(XX) KITS:

PICTURE IS AN APPROXIMATE REPRESENTATION. NOT TO EXACT SCALE OR PROPORTION. ALL MEASUREMENTS IN INCHES. BUSHING DIAMETERS (TOP ROW) ARE OPTIMAL AND SHOULD VARY BY NO MORE THAN .002" WHEN NEW.

ID NUMBER PKBULPENBU **TYPE:** BUSHING

NOTES:

NUMBER OF PARTS 3

THRU HOLE STANDARD (0.248')

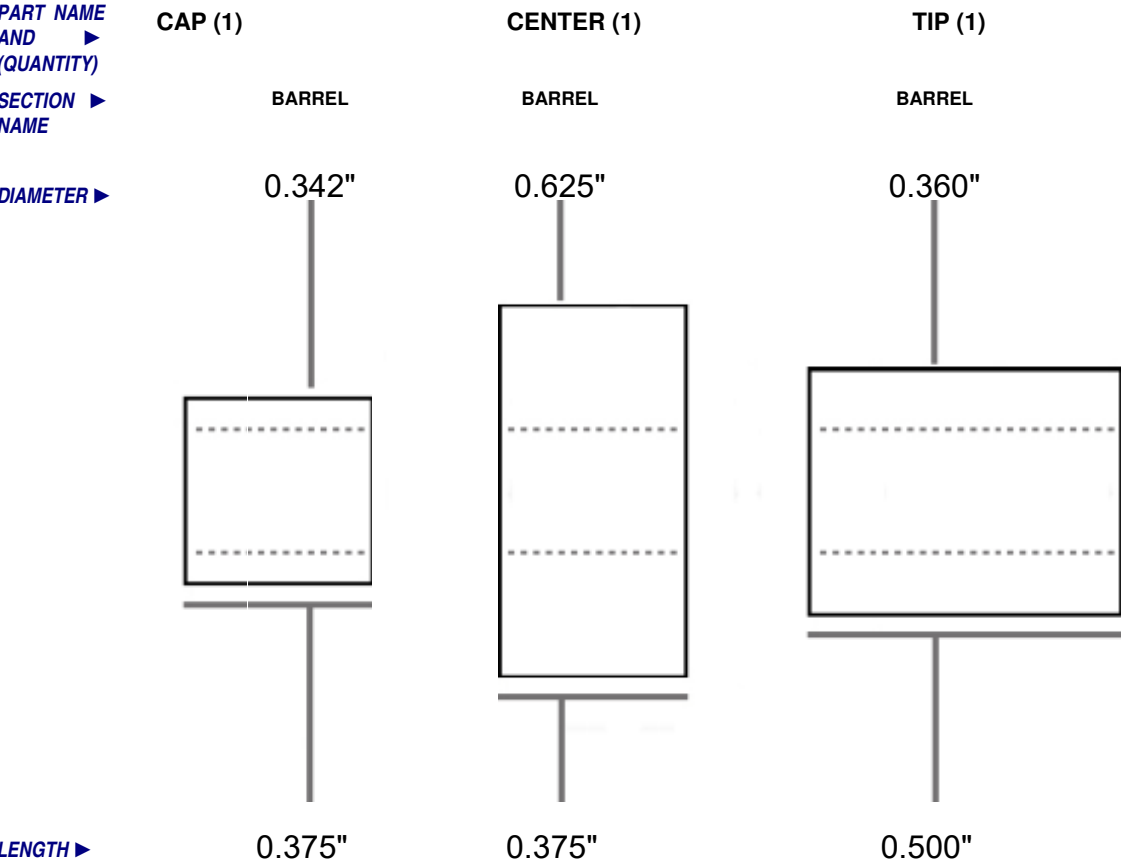

ASSOCIATED PKBULPEN(XX)
KITS:

PICTURE IS AN APPROXIMATE REPRESENTATION. NOT TO EXACT SCALE OR PROPORTION. ALL MEASUREMENTS IN INCHES. BUSHING DIAMETERS (TOP ROW) ARE OPTIMAL AND SHOULD VARY BY NO MORE THAN .002" WHEN NEW.

ID NUMBER PKCAMBU

TYPE: BUSHING

NOTES:

NUMBER OF PARTS 3

THRU HOLE STANDARD (0.248')

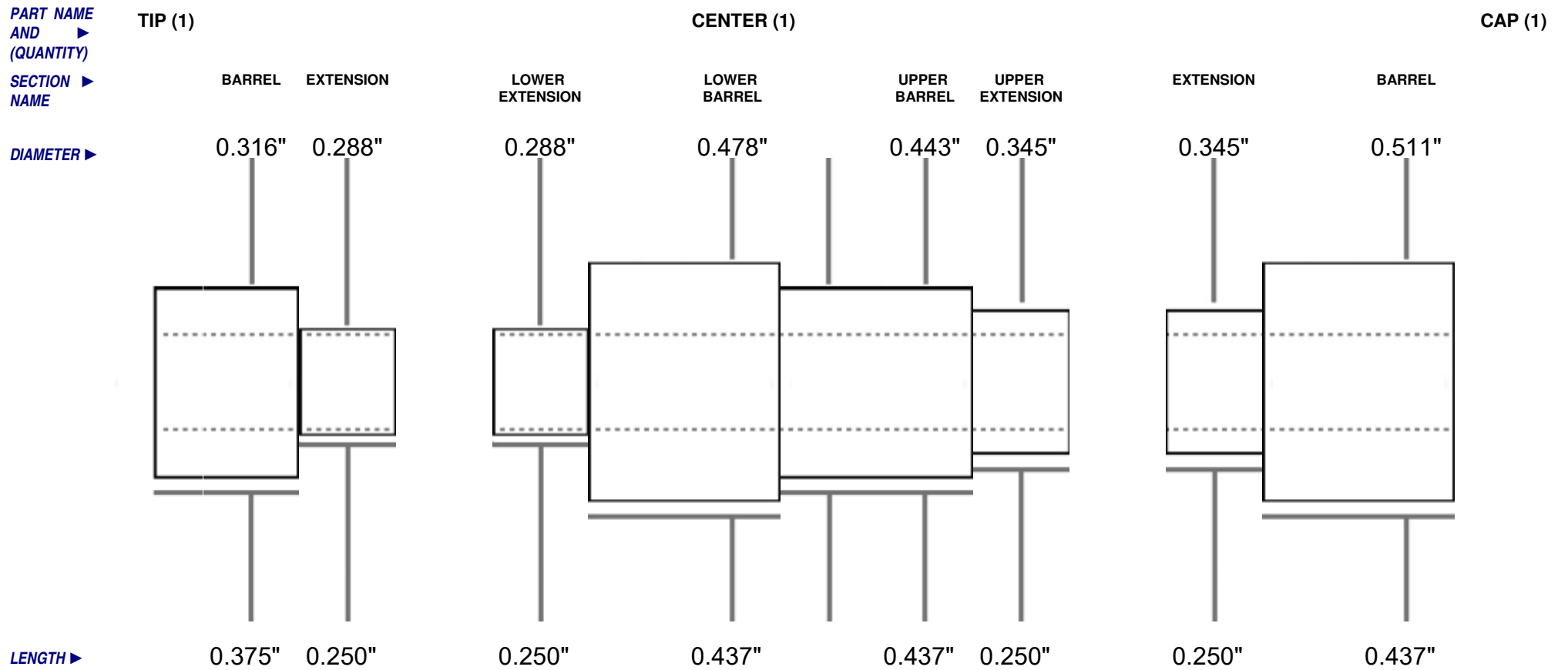

ASSOCIATED PKCAM(XX)

KITS:

PICTURE IS AN APPROXIMATE REPRESENTATION. NOT TO EXACT SCALE OR PROPORTION. ALL MEASUREMENTS IN INCHES. BUSHING DIAMETERS (TOP ROW) ARE OPTIMAL AND SHOULD VARY BY NO MORE THAN .002" WHEN NEW.

ID NUMBER PKCEOBU

TYPE: BUSHING

NOTES: CAP AND TIP SAME DIAMETERS

NUMBER OF PARTS 2

THRU HOLE STANDARD (0.248')

PART NAME AND (QUANTITY)

SECTION NAME

DIAMETER

LENGTH

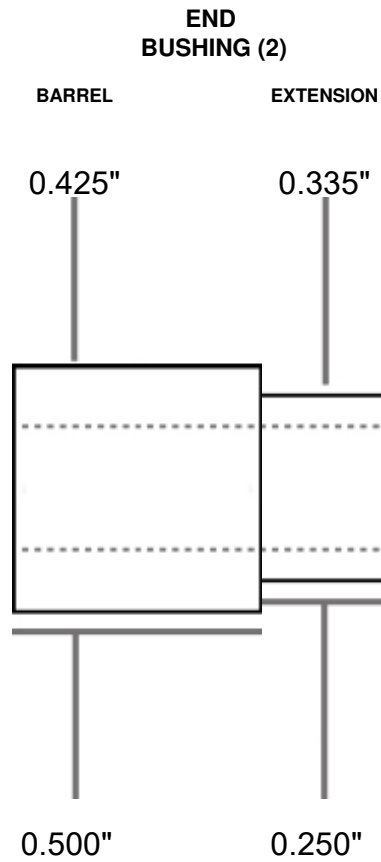

ASSOCIATED PKCEO(XX)

KITS:

PICTURE IS AN APPROXIMATE REPRESENTATION. NOT TO EXACT SCALE OR PROPORTION. ALL MEASUREMENTS IN INCHES. BUSHING DIAMETERS (TOP ROW) ARE OPTIMAL AND SHOULD VARY BY NO MORE THAN .002" WHEN NEW.

ID NUMBER PKCFBUSH **TYPE:** BUSHING

NUMBER OF PARTS 3

THRU HOLE STANDARD(0.248")

NOTES: TO TURN LOWER BARREL WITHOUT COMFORT GRIP
SUBSTITUTE A STANDARD 7MM SPACER/SLIMLINE BUSHING AT
THE TIP

**PART NAME
AND
(QUANTITY)**

CAP (1)

TIP/CENTER
(1)

**SECTION
NAME**

BARREL
DIAMETER

BARREL
DIAMETER

DIAMETER

0.330"

0.420"

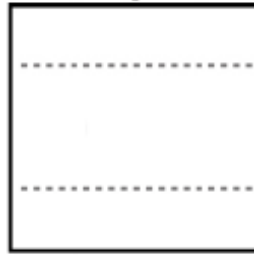

LENGTH

0.377"

0.440"

ASSOCIATED PKCFFUN(XX), PKCFPCL(XX), PKCFPEN(XX), PKDU(XX), PKDUN(XX), PKDUX(XX)

KITS:

PICTURE IS AN APPROXIMATE REPRESENTATION. NOT TO EXACT SCALE OR PROPORTION. ALL MEASUREMENTS IN INCHES. BUSHING DIAMETERS (TOP ROW) ARE OPTIMAL AND SHOULD VARY BY NO MORE THAN .002" WHEN NEW.

ID NUMBER PKCHPENBU **TYPE:** BUSHING

NOTES: BOTH BUSHINGS HAVE SAME DIMENSIONS

NUMBER OF PARTS 2

THRU HOLE STANDARD(0.248")

PART NAME AND (QUANTITY)

SECTION NAME

DIAMETER

LENGTH

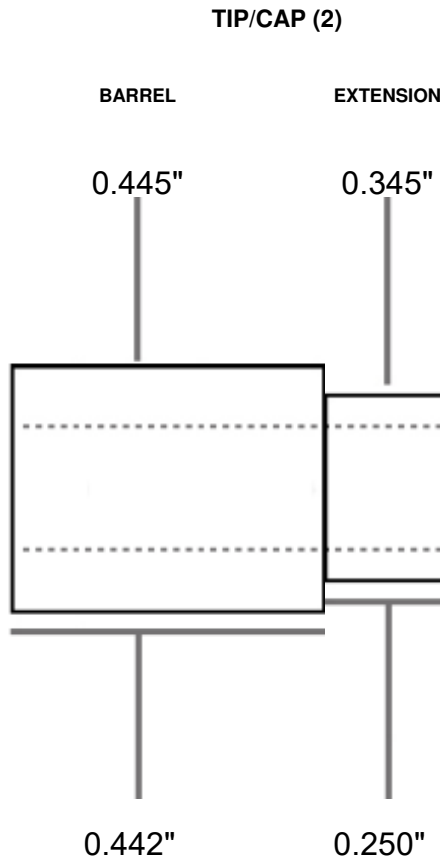

ASSOCIATED MCM-CH(XX), PKCHPEN(XX), PKCLBA(XX), PKKPCL(XX), PKKPEN(XX), PKRB10(XX), PKSWST(XX)

KITS:

PICTURE IS AN APPROXIMATE REPRESENTATION. NOT TO EXACT SCALE OR PROPORTION. ALL MEASUREMENTS IN INCHES. BUSHING DIAMETERS (TOP ROW) ARE OPTIMAL AND SHOULD VARY BY NO MORE THAN .002" WHEN NEW.

ID NUMBER PKCKBU

TYPE: BUSHING

NOTES: BOTH SIDES SAME DIMENSION

NUMBER OF PARTS 2

THRU HOLE STANDARD (0.248')

PART NAME AND (QUANTITY)

SECTION NAME

DIAMETER

LENGTH

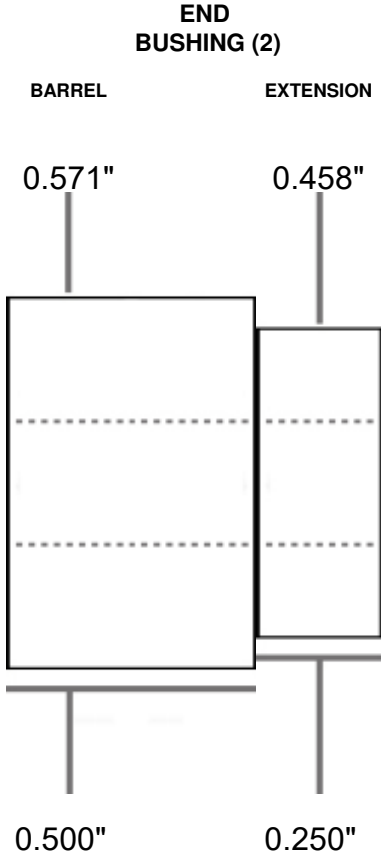

**ASSOCIATED PKCK(XX), PKTS3(XX)
KITS:**

PICTURE IS AN APPROXIMATE REPRESENTATION. NOT TO EXACT SCALE OR PROPORTION. ALL MEASUREMENTS IN INCHES. BUSHING DIAMETERS (TOP ROW) ARE OPTIMAL AND SHOULD VARY BY NO MORE THAN .002" WHEN NEW.

ID NUMBER PKCLBU

TYPE: BUSHING

NOTES:

NUMBER OF PARTS 3

THRU HOLE STANDARD (0.248')

PART NAME AND (QUANTITY)

CAP (1)

CENTER (1)

TIP (1)

SECTION NAME

BARREL

BARREL

BARREL

DIAMETER

0.370"

0.420"

0.330"

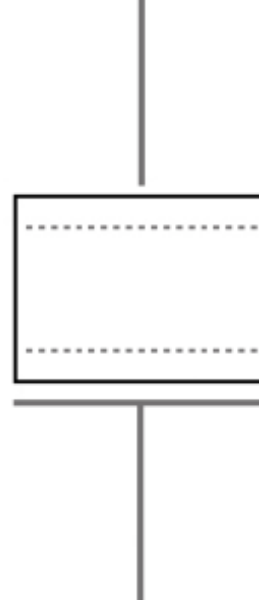
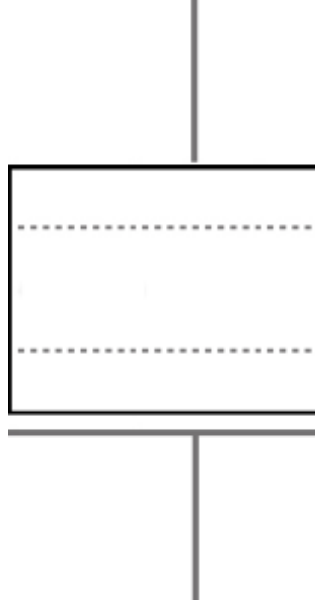
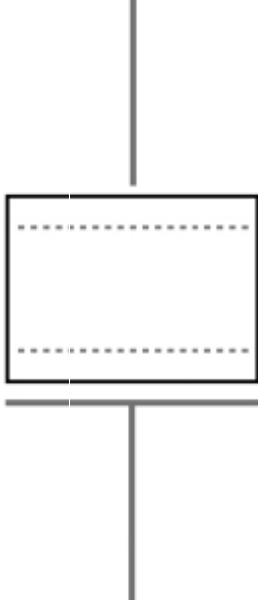

LENGTH

0.437"

0.500"

0.375"

ASSOCIATED PKCLPEN(XX)

KITS:

PICTURE IS AN APPROXIMATE REPRESENTATION. NOT TO EXACT SCALE OR PROPORTION. ALL MEASUREMENTS IN INCHES. BUSHING DIAMETERS (TOP ROW) ARE OPTIMAL AND SHOULD VARY BY NO MORE THAN .002" WHEN NEW.

ID NUMBER PKCLFPBU **TYPE:** BUSHING

NOTES:

NUMBER OF PARTS 2

THRU HOLE STANDARD (0.248')

PART NAME AND (QUANTITY)

SECTION NAME

DIAMETER

LENGTH

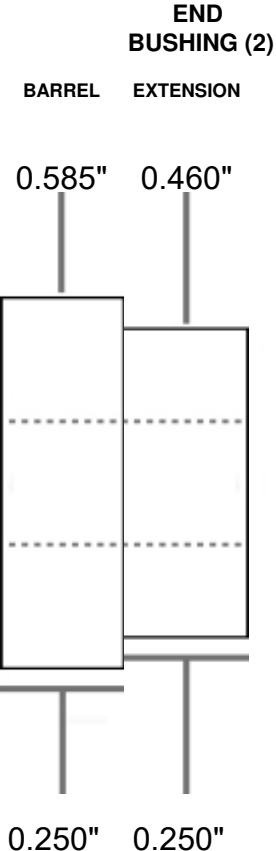

ASSOCIATED KITS: PKCLFP(XX)

PICTURE IS AN APPROXIMATE REPRESENTATION. NOT TO EXACT SCALE OR PROPORTION. ALL MEASUREMENTS IN INCHES. BUSHING DIAMETERS (TOP ROW) ARE OPTIMAL AND SHOULD VARY BY NO MORE THAN .002" WHEN NEW.

ID NUMBER PKCMRBU

TYPE: BUSHING

NOTES:

NUMBER OF PARTS 3

THRU HOLE STANDARD (0.248')

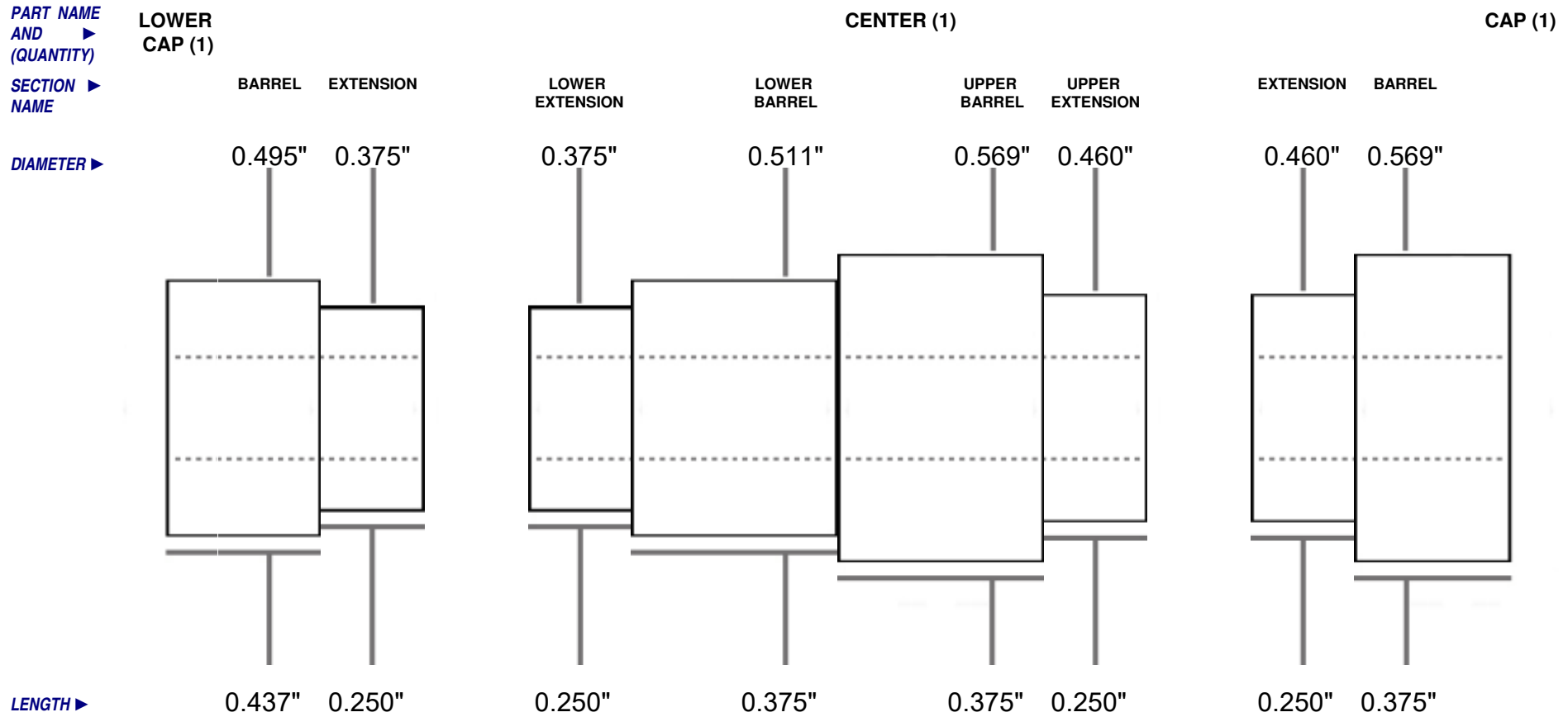

ASSOCIATED PKCMF(XX), PKCMR(XX)
KITS:

PICTURE IS AN APPROXIMATE REPRESENTATION. NOT TO EXACT SCALE OR PROPORTION. ALL MEASUREMENTS IN INCHES. BUSHING DIAMETERS (TOP ROW) ARE OPTIMAL AND SHOULD VARY BY NO MORE THAN .002" WHEN NEW.

ID NUMBER PKCONBU

TYPE: BUSHING

NOTES:

NUMBER OF PARTS 3

THRU HOLE STANDARD(0.248")

PART NAME AND (QUANTITY)

SECTION NAME

DIAMETER

LENGTH

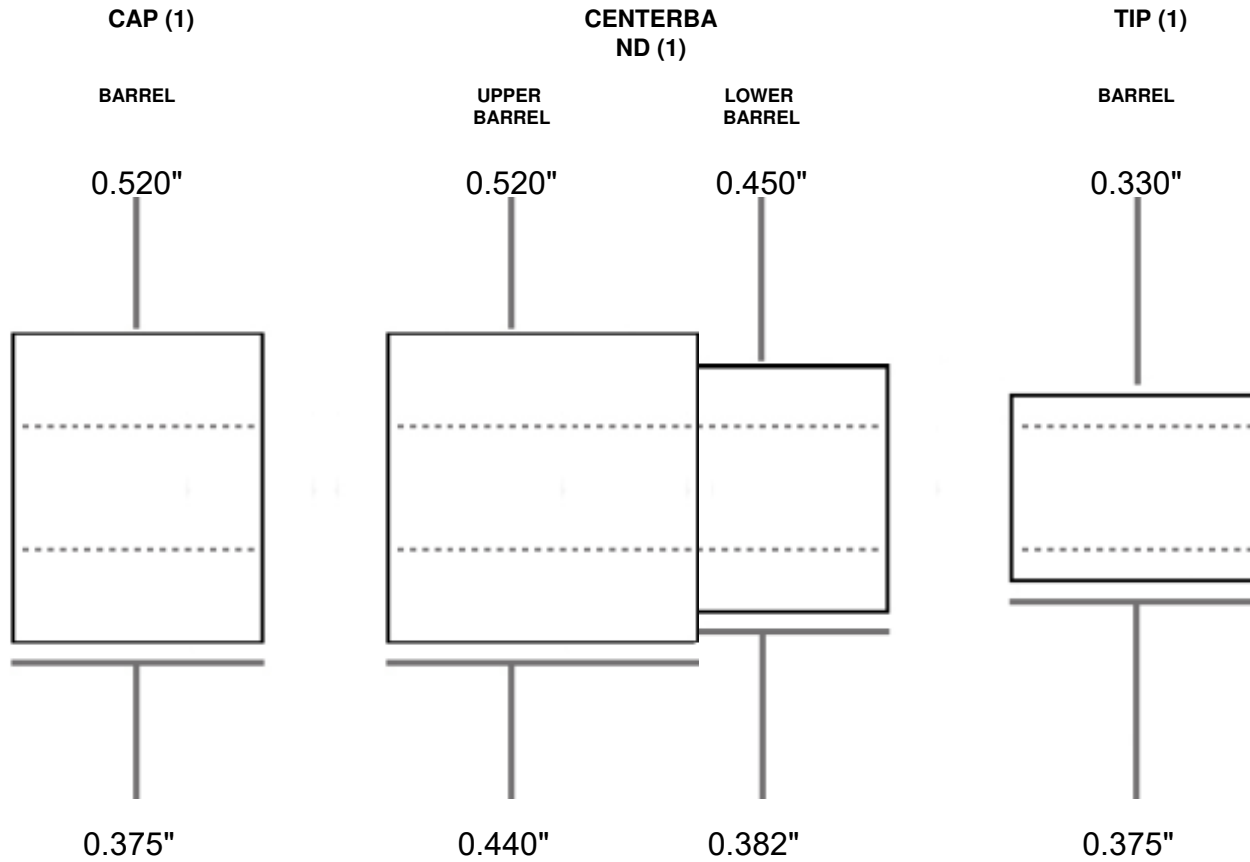

ASSOCIATED PKCON(XX)

KITS:

PICTURE IS AN APPROXIMATE REPRESENTATION. NOT TO EXACT SCALE OR PROPORTION. ALL MEASUREMENTS IN INCHES. BUSHING DIAMETERS (TOP ROW) ARE OPTIMAL AND SHOULD VARY BY NO MORE THAN .002" WHEN NEW.

ID NUMBER PKCORBU

TYPE: BUSHING

NOTES: CAP/TIP SAME SIZE

NUMBER OF PARTS 2

THRU HOLE STANDARD (0.248')

PART NAME AND (QUANTITY)

SECTION NAME

DIAMETER

LENGTH

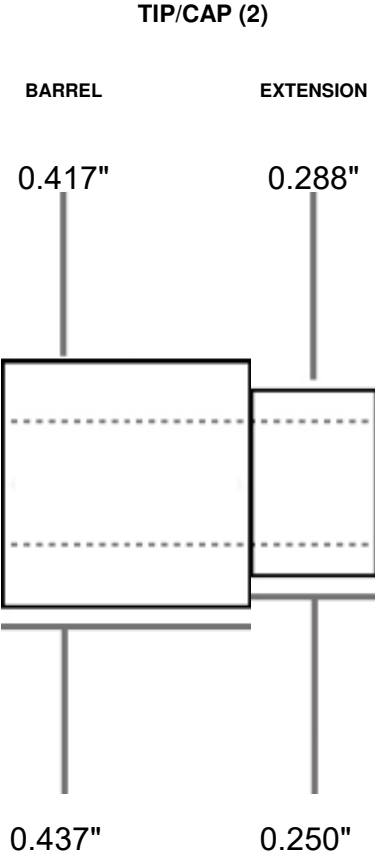

ASSOCIATED PKCORP(XX), PKCORS(XX)
KITS:

PICTURE IS AN APPROXIMATE REPRESENTATION. NOT TO EXACT SCALE OR PROPORTION. ALL MEASUREMENTS IN INCHES. BUSHING DIAMETERS (TOP ROW) ARE OPTIMAL AND SHOULD VARY BY NO MORE THAN .002" WHEN NEW.

ID NUMBER PKCP2400BU **TYPE:** BUSHING

NOTES: BOTH BUSHINGS HAVE THE SAME DIMENSION

NUMBER OF PARTS 2

THRU HOLE STANDARD(0.248")

PART NAME AND (QUANTITY)

SECTION NAME

DIAMETER

LENGTH

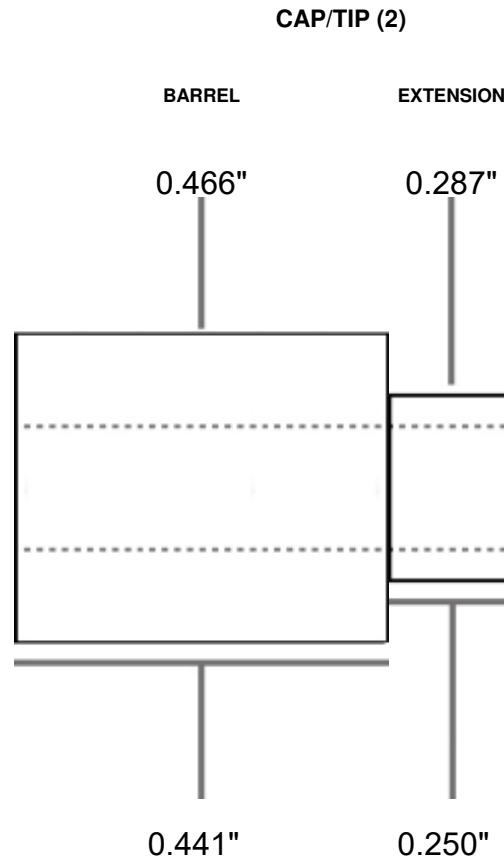

ASSOCIATED PKCP24(XX), PKCP25(XX)

KITS:

PICTURE IS AN APPROXIMATE REPRESENTATION. NOT TO EXACT SCALE OR PROPORTION. ALL MEASUREMENTS IN INCHES. BUSHING DIAMETERS (TOP ROW) ARE OPTIMAL AND SHOULD VARY BY NO MORE THAN .002" WHEN NEW.

ID NUMBER PKCP3000BU **TYPE:** BUSHING

NOTES: BOTH SIDES ARE SAME DIMENSIONS

NUMBER OF PARTS 2

THRU HOLE STANDARD(0.248")

PART NAME AND (QUANTITY)

SECTION NAME

DIAMETER

LENGTH

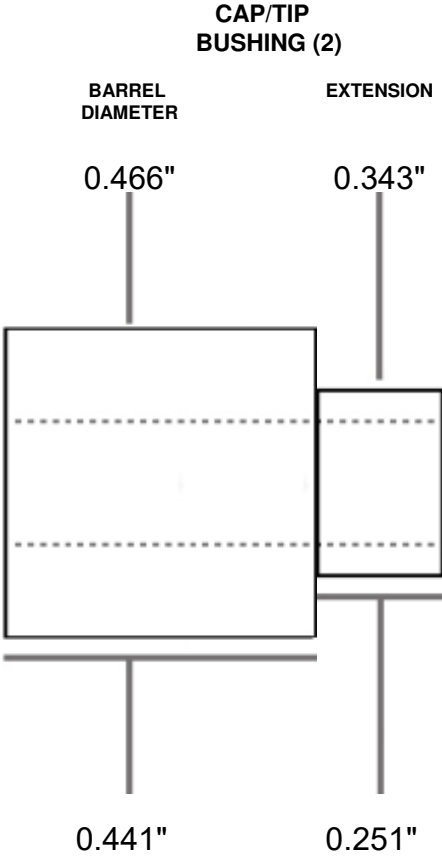

ASSOCIATED KITS: PKCOS(XX), PKCP30(XX), PKCP35(XX), PKCP36(XX), PKCP38(XX), PKCP80(XX), PKCP81(XX), PKCP82(XX), PKCP8AE(XX), PKCP8AR(XX), PKCP8DH(XX), PKCP8SL(XX), PKFAL(XX)

PICTURE IS AN APPROXIMATE REPRESENTATION. NOT TO EXACT SCALE OR PROPORTION. ALL MEASUREMENTS IN INCHES. BUSHING DIAMETERS (TOP ROW) ARE OPTIMAL AND SHOULD VARY BY NO MORE THAN .002" WHEN NEW.

ID NUMBER PKCP6000BU **TYPE:** BUSHING

NOTES:

NUMBER OF PARTS 3

THRU HOLE STANDARD(0.248")

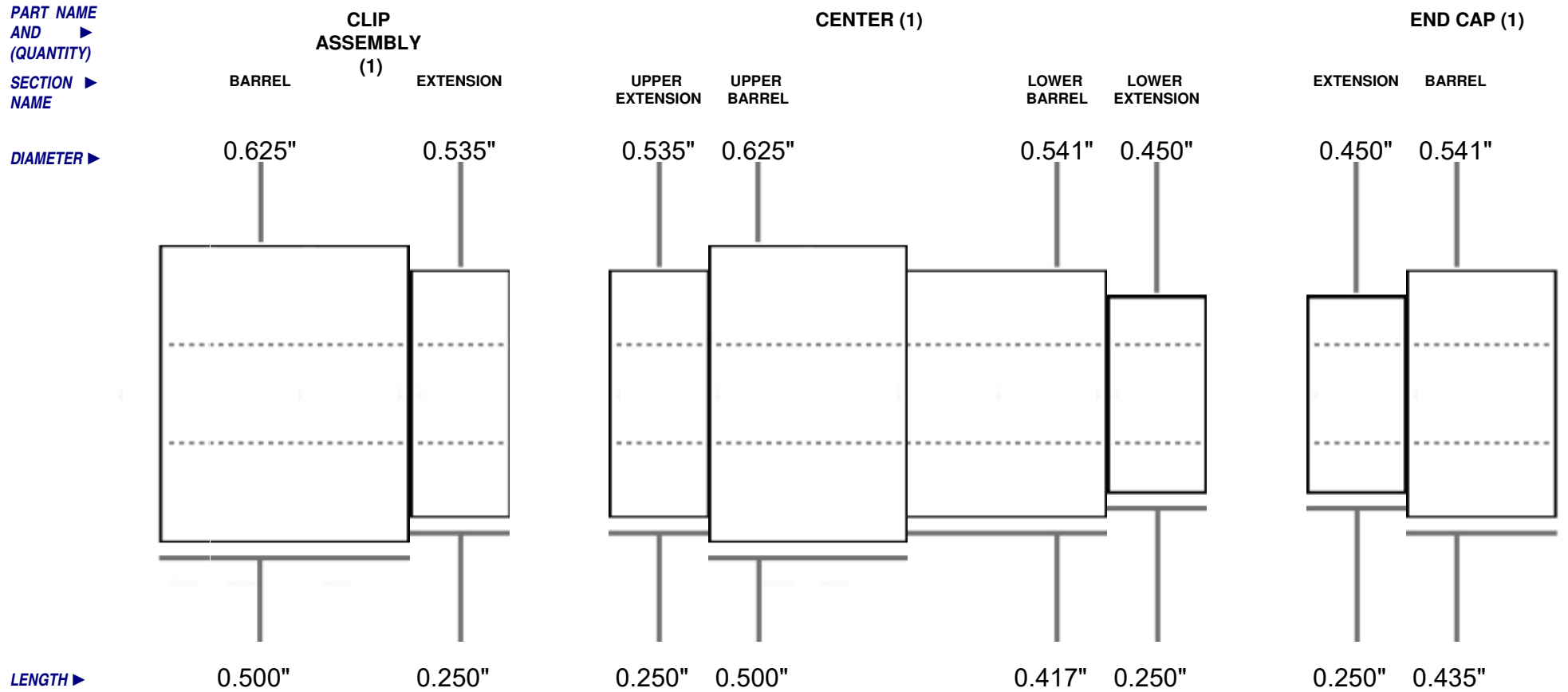

ASSOCIATED KITS: PKCP60(XX), PKCP61(XX)

PICTURE IS AN APPROXIMATE REPRESENTATION. NOT TO EXACT SCALE OR PROPORTION. ALL MEASUREMENTS IN INCHES. BUSHING DIAMETERS (TOP ROW) ARE OPTIMAL AND SHOULD VARY BY NO MORE THAN .002" WHEN NEW.

ID NUMBER PKCP7000BU **TYPE:** BUSHING

NOTES: BOTH SIDES HAVE THE SAME DIMENSION

NUMBER OF PARTS 2

THRU HOLE STANDARD(0.248")

PART NAME AND (QUANTITY)

SECTION NAME

DIAMETER

LENGTH

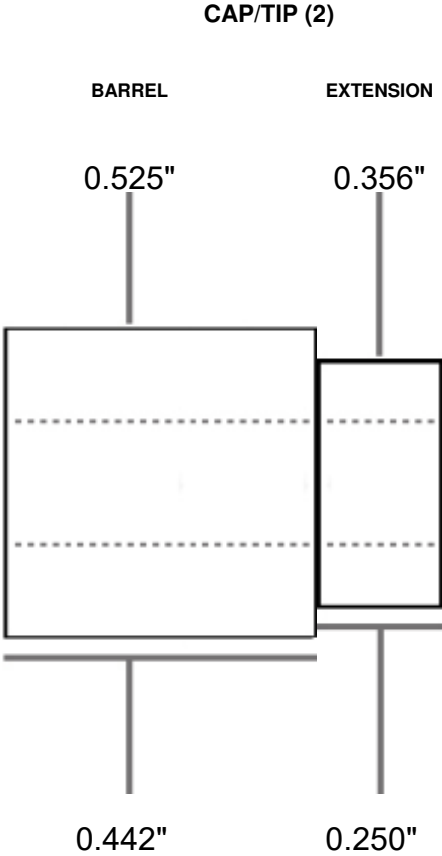

ASSOCIATED KITS: PKCP70(XX), PKCP75(XX), PKRAMAG(XX)

PICTURE IS AN APPROXIMATE REPRESENTATION. NOT TO EXACT SCALE OR PROPORTION. ALL MEASUREMENTS IN INCHES. BUSHING DIAMETERS (TOP ROW) ARE OPTIMAL AND SHOULD VARY BY NO MORE THAN .002" WHEN NEW.

ID NUMBER PKCP9000BU **TYPE:** BUSHING

NOTES: CAP AND TIP SAME MEASUREMENTS

NUMBER OF PARTS 2

THRU HOLE STANDARD(0.248")

PART NAME AND (QUANTITY)

SECTION NAME

DIAMETER

LENGTH

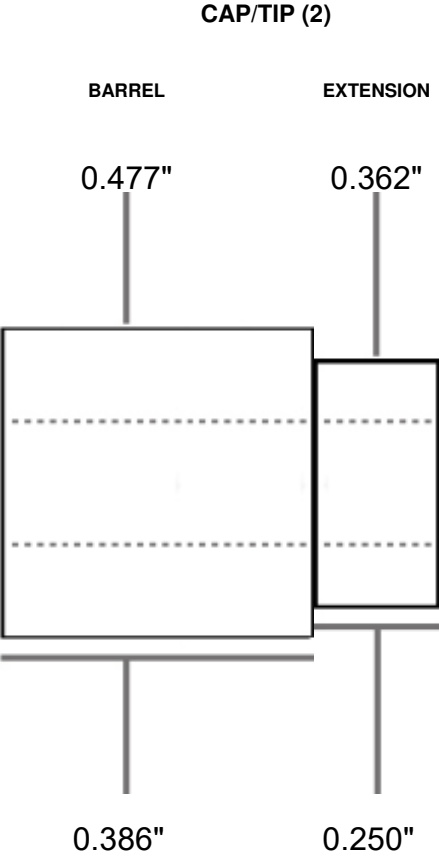

ASSOCIATED PKCP90(XX)
KITS:

PICTURE IS AN APPROXIMATE REPRESENTATION. NOT TO EXACT SCALE OR PROPORTION. ALL MEASUREMENTS IN INCHES. BUSHING DIAMETERS (TOP ROW) ARE OPTIMAL AND SHOULD VARY BY NO MORE THAN .002" WHEN NEW.

ID NUMBER PKCPENRBU **TYPE:** BUSHING

NOTES:

NUMBER OF PARTS 3

THRU HOLE STANDARD (0.248")

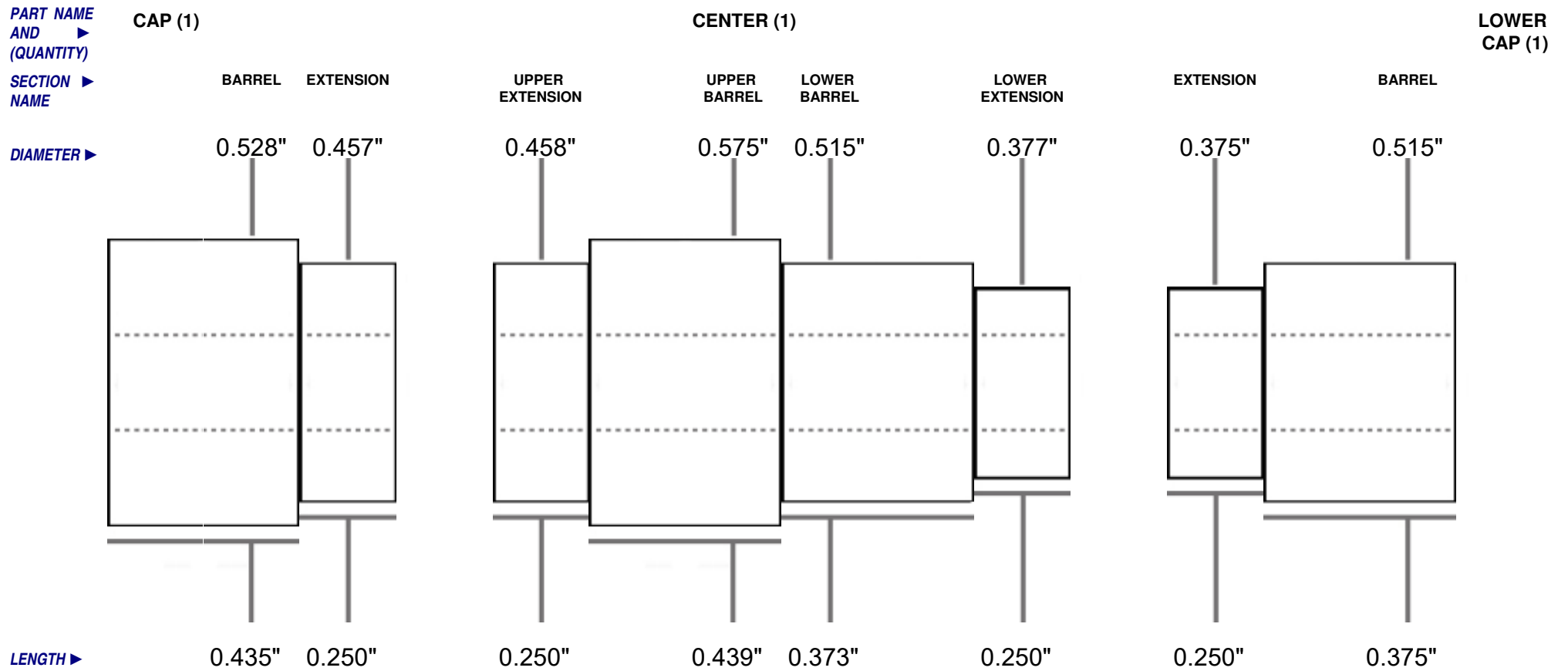

ASSOCIATED PKCPENF(XX), PKCPENR(XX)
KITS:

PICTURE IS AN APPROXIMATE REPRESENTATION. NOT TO EXACT SCALE OR PROPORTION. ALL MEASUREMENTS IN INCHES. BUSHING DIAMETERS (TOP ROW) ARE OPTIMAL AND SHOULD VARY BY NO MORE THAN .002" WHEN NEW.

ID NUMBER PKCSCOOPBU **TYPE:** BUSHING

NOTES:

NUMBER OF PARTS 2

THRU HOLE STANDARD(0.248")

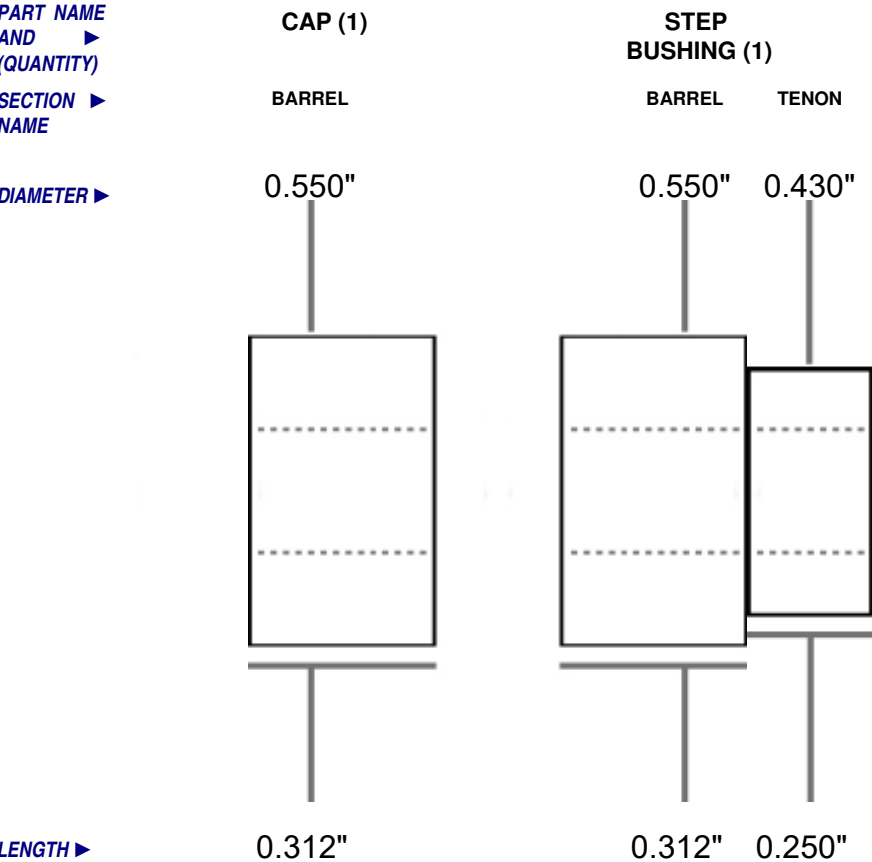

ASSOCIATED PKCSCOOP(XX), PKCSCOOP2(XX)
KITS:

PICTURE IS AN APPROXIMATE REPRESENTATION. NOT TO EXACT SCALE OR PROPORTION. ALL MEASUREMENTS IN INCHES. BUSHING DIAMETERS (TOP ROW) ARE OPTIMAL AND SHOULD VARY BY NO MORE THAN .002" WHEN NEW.

ID NUMBER PKCTPENBU **TYPE:** BUSHING

NOTES:

NUMBER OF PARTS 2

THRU HOLE STANDARD (0.248')

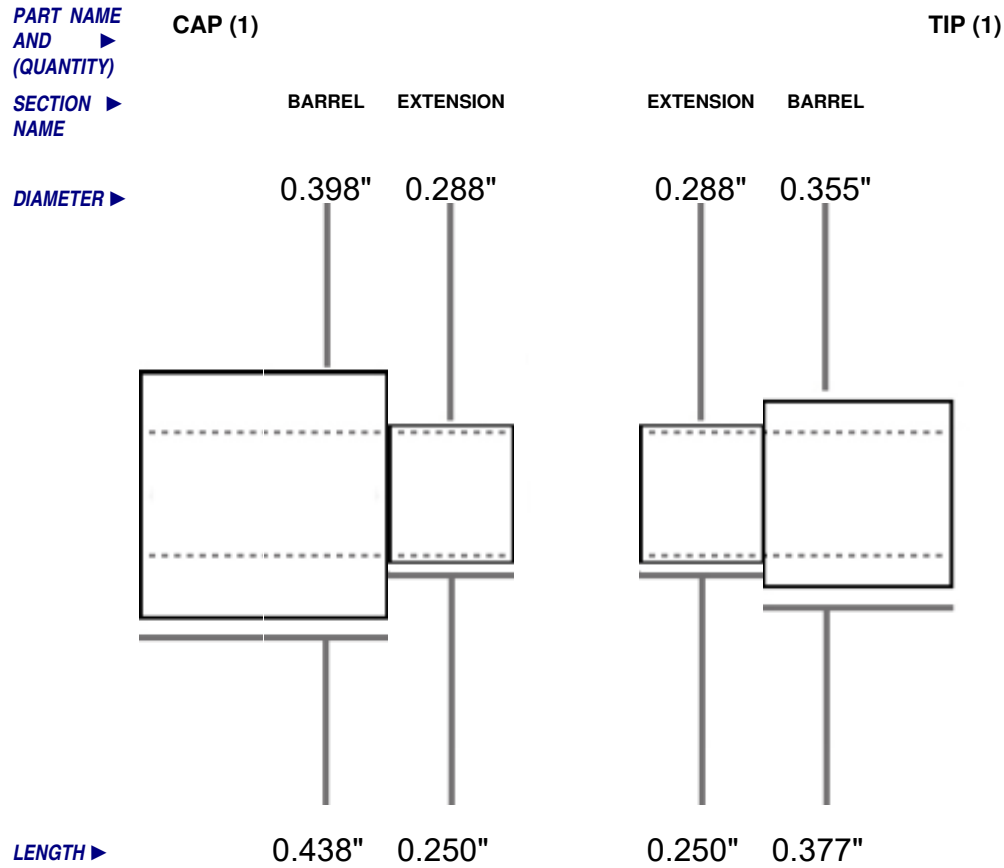

ASSOCIATED PKCTPEN(XX)
KITS:

PICTURE IS AN APPROXIMATE REPRESENTATION. NOT TO EXACT SCALE OR PROPORTION. ALL MEASUREMENTS IN INCHES. BUSHING DIAMETERS (TOP ROW) ARE OPTIMAL AND SHOULD VARY BY NO MORE THAN .002" WHEN NEW.

ID NUMBER PKCWPENBU **TYPE:** BUSHING

NOTES:

NUMBER OF PARTS 2

THRU HOLE STANDARD(0.248")

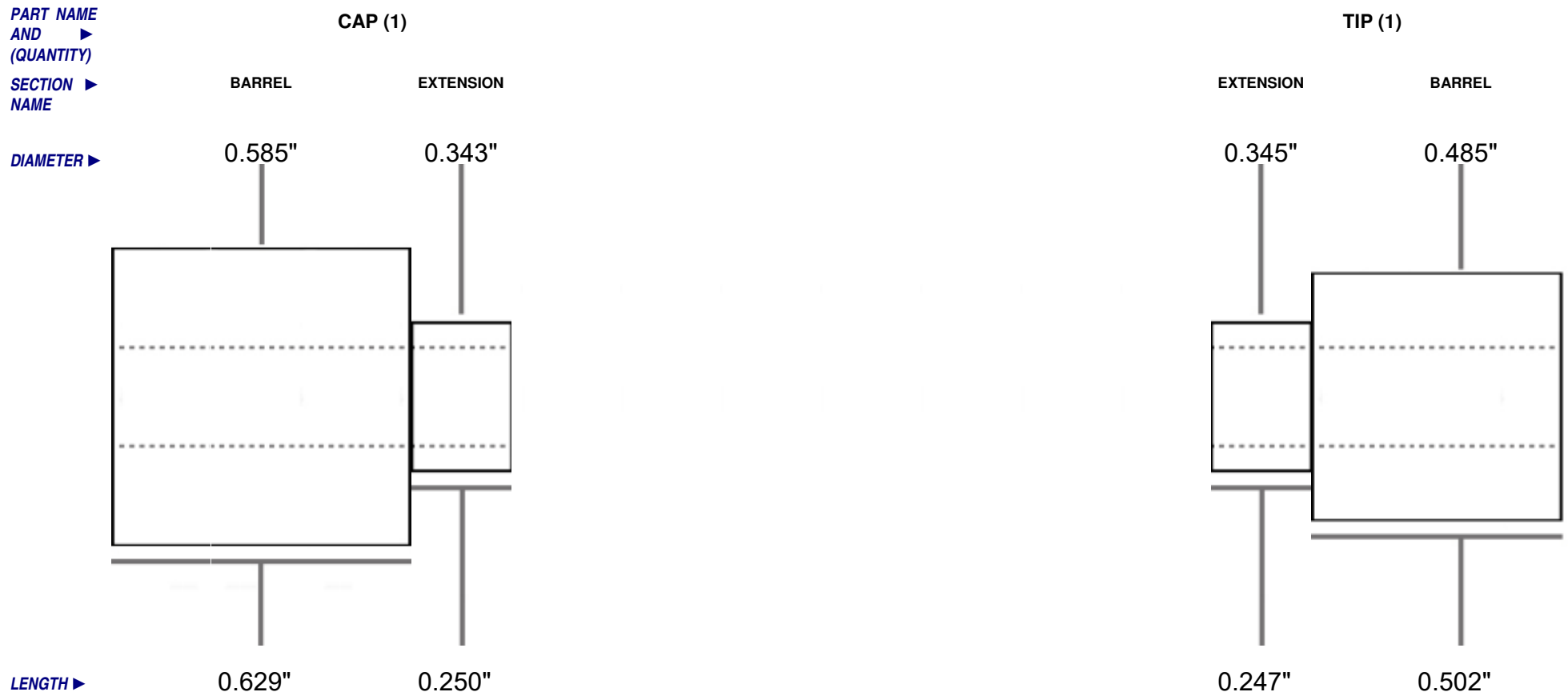

ASSOCIATED PKCWPEN(XX)

KITS:

PICTURE IS AN APPROXIMATE REPRESENTATION. NOT TO EXACT SCALE OR PROPORTION. ALL MEASUREMENTS IN INCHES. BUSHING DIAMETERS (TOP ROW) ARE OPTIMAL AND SHOULD VARY BY NO MORE THAN .002" WHEN NEW.

ID NUMBER PKDBBUA

TYPE: BUSHING

NOTES:

NUMBER OF PARTS 3

THRU HOLE STANDARD(0.248")

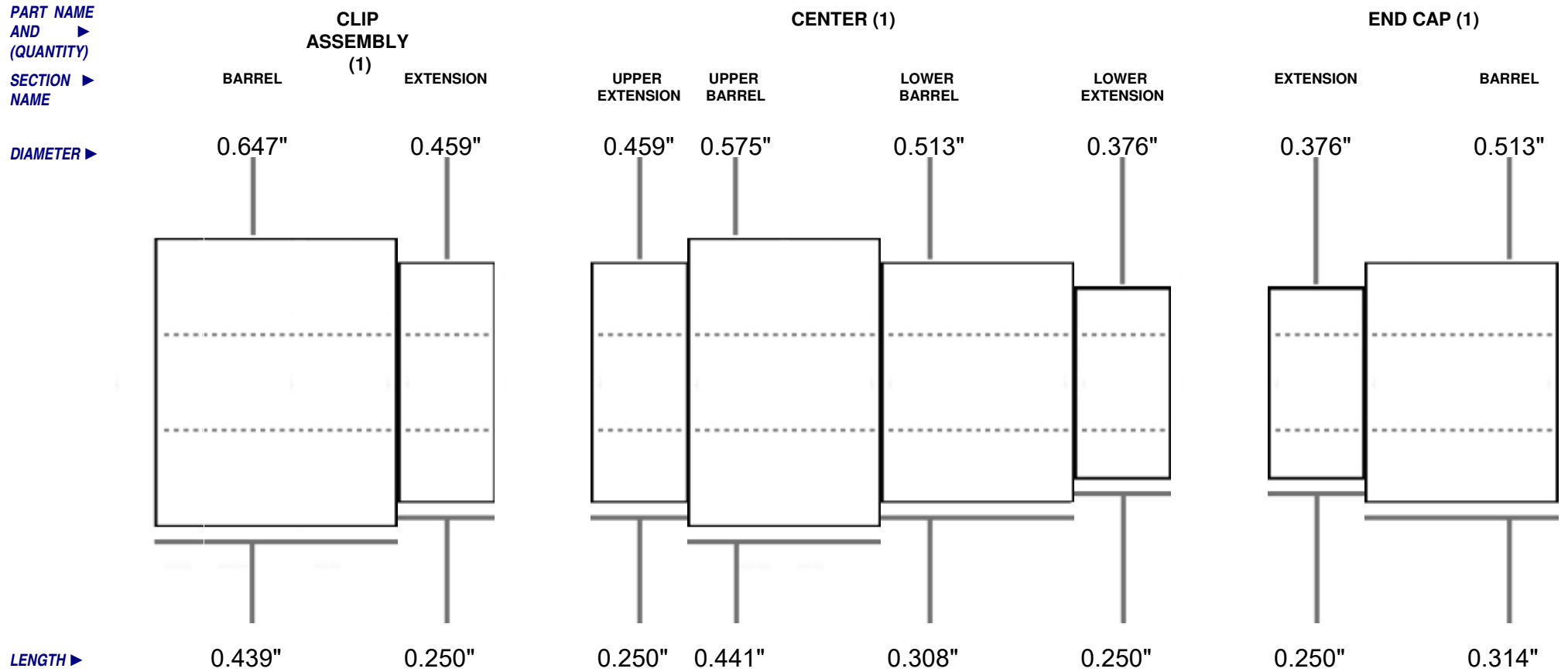

ASSOCIATED PKDBF(XX), PKDBR(XX)

KITS:

PICTURE IS AN APPROXIMATE REPRESENTATION. NOT TO EXACT SCALE OR PROPORTION. ALL MEASUREMENTS IN INCHES. BUSHING DIAMETERS (TOP ROW) ARE OPTIMAL AND SHOULD VARY BY NO MORE THAN .002" WHEN NEW.

ID NUMBER PKDCM100

TYPE: DRILL CHUCK MANDREL

NOTES: FITS IN HEADSTOCK MOUNTED DRILL CHUCK

NUMBER OF PARTS 1

THRU HOLE NONE

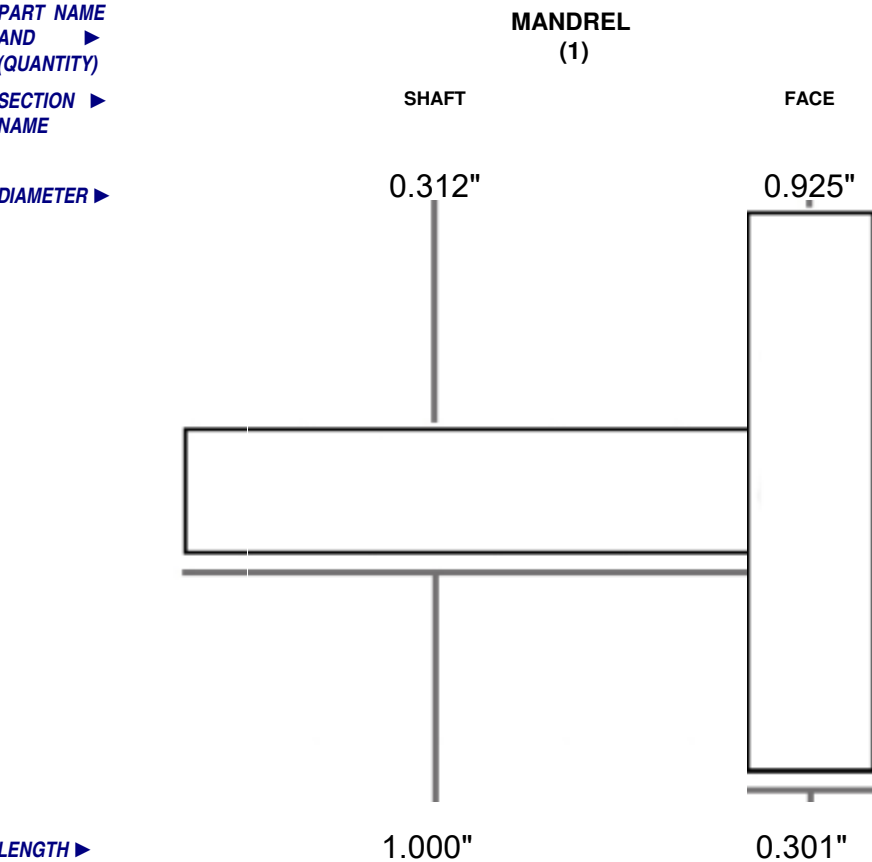

ASSOCIATED PKBMF(XX), PKKHANG(XX)
KITS:

PICTURE IS AN APPROXIMATE REPRESENTATION. NOT TO EXACT SCALE OR PROPORTION. ALL MEASUREMENTS IN INCHES. BUSHING DIAMETERS (TOP ROW) ARE OPTIMAL AND SHOULD VARY BY NO MORE THAN .002" WHEN NEW.

ID NUMBER PKDCM125

TYPE: DRILL CHUCK MANDREL

NOTES: FITS IN HEADSTOCK MOUNTED DRILL CHUCK

NUMBER OF PARTS 1

THRU HOLE NONE

PART NAME AND (QUANTITY)

MANDREL (1)

SECTION NAME

SHANK

FACEPLATE

DIAMETER

0.312"

1.250"

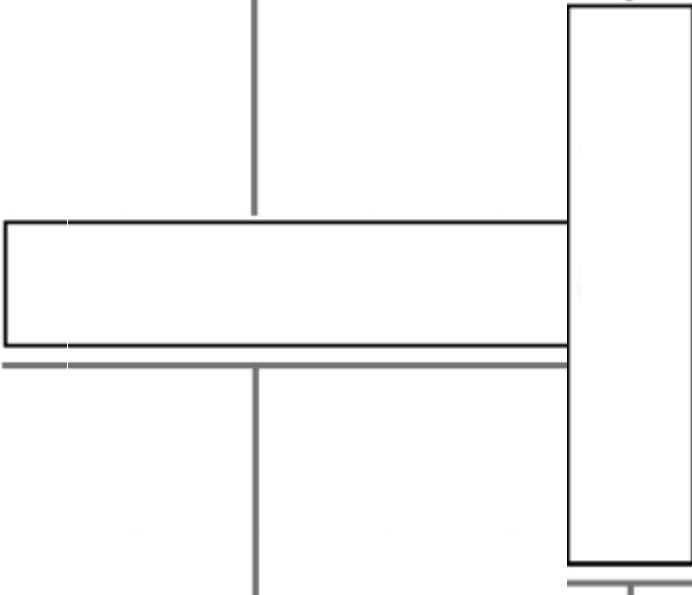

LENGTH

1.000"

0.300"

ASSOCIATED PHANG2(XX)

KITS:

PICTURE IS AN APPROXIMATE REPRESENTATION. NOT TO EXACT SCALE OR PROPORTION. ALL MEASUREMENTS IN INCHES. BUSHING DIAMETERS (TOP ROW) ARE OPTIMAL AND SHOULD VARY BY NO MORE THAN .002" WHEN NEW.

ID NUMBER PKDCM150

TYPE: DRILL CHUCK MANDREL

NOTES: FITS IN HEADSTOCK MOUNTED DRILL CHUCK

NUMBER OF PARTS 1

THRU HOLE NONE

PART NAME AND (QUANTITY)

MANDREL (1)

SECTION NAME

SHAFT

FACEPLATE

DIAMETER

0.313"

1.500"

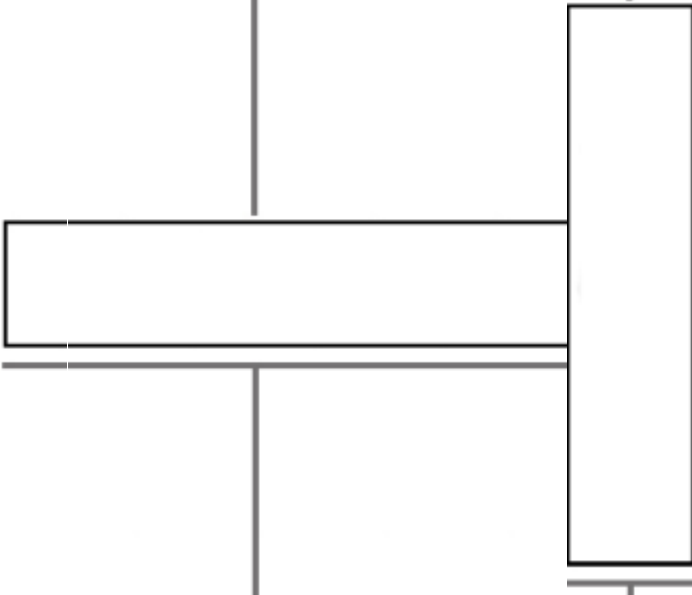

LENGTH

1.000"

0.300"

ASSOCIATED KITS:

PICTURE IS AN APPROXIMATE REPRESENTATION. NOT TO EXACT SCALE OR PROPORTION. ALL MEASUREMENTS IN INCHES. BUSHING DIAMETERS (TOP ROW) ARE OPTIMAL AND SHOULD VARY BY NO MORE THAN .002" WHEN NEW.

ID NUMBER PKDCM1916

TYPE: DRILL CHUCK MANDREL

NOTES: FITS IN HEADSTOCK MOUNTED DRILL CHUCK

NUMBER OF PARTS 1

THRU HOLE NONE

PART NAME AND (QUANTITY)

MANDREL (1)

SECTION NAME

SHAFT

FACEPLATE

DIAMETER

0.311"

1.568"

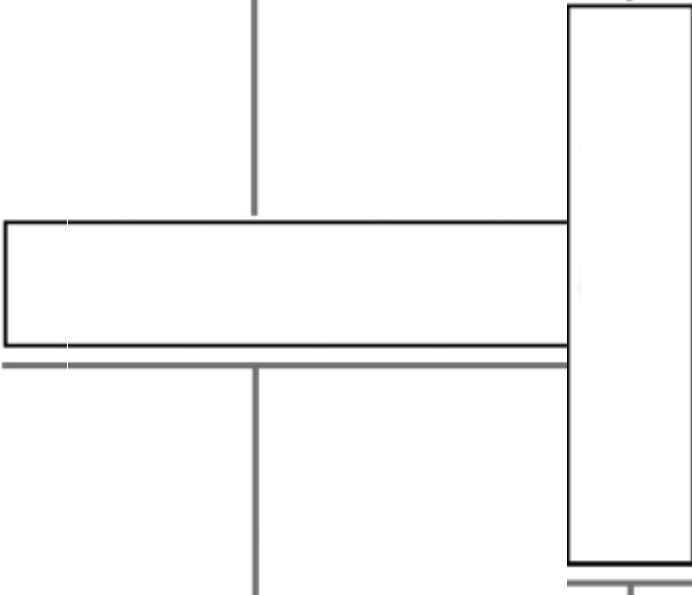

LENGTH

1.000"

0.300"

ASSOCIATED PKMBX(XX)

KITS:

PICTURE IS AN APPROXIMATE REPRESENTATION. NOT TO EXACT SCALE OR PROPORTION. ALL MEASUREMENTS IN INCHES. BUSHING DIAMETERS (TOP ROW) ARE OPTIMAL AND SHOULD VARY BY NO MORE THAN .002" WHEN NEW.

ID NUMBER PKDCM200

TYPE: DRILL CHUCK MANDREL

NOTES: FITS IN HEADSTOCK MOUNTED DRILL CHUCK

NUMBER OF PARTS 1

THRU HOLE NONE

PART NAME AND (QUANTITY)

CHUCK MANDREL (1)

SECTION NAME

SHAFT

FACEPLATE

DIAMETER

0.312"

2.000"

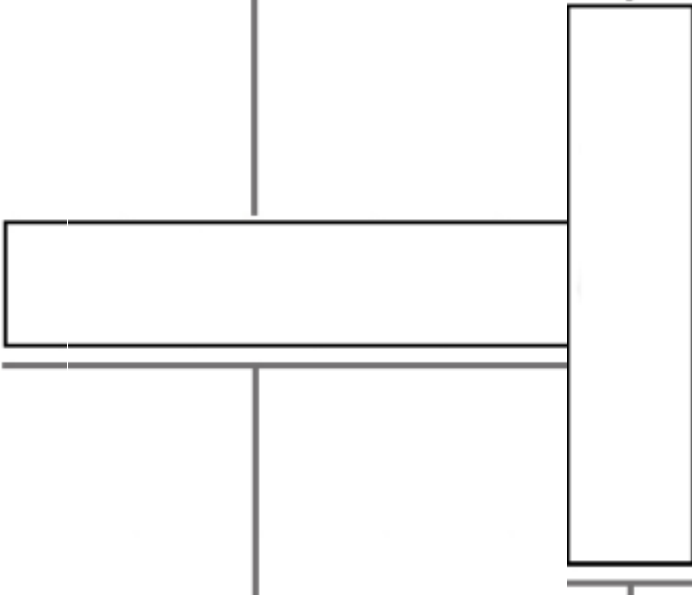

LENGTH

1.000"

0.304"

ASSOCIATED PKPWMAG(XX)

KITS:

PICTURE IS AN APPROXIMATE REPRESENTATION. NOT TO EXACT SCALE OR PROPORTION. ALL MEASUREMENTS IN INCHES. BUSHING DIAMETERS (TOP ROW) ARE OPTIMAL AND SHOULD VARY BY NO MORE THAN .002" WHEN NEW.

ID NUMBER PKDCMBS

TYPE: DRILL CHUCK MANDREL

NOTES: FITS IN HEADSTOCK MOUNTED DRILL CHUCK

NUMBER OF PARTS 1

THRU HOLE NONE

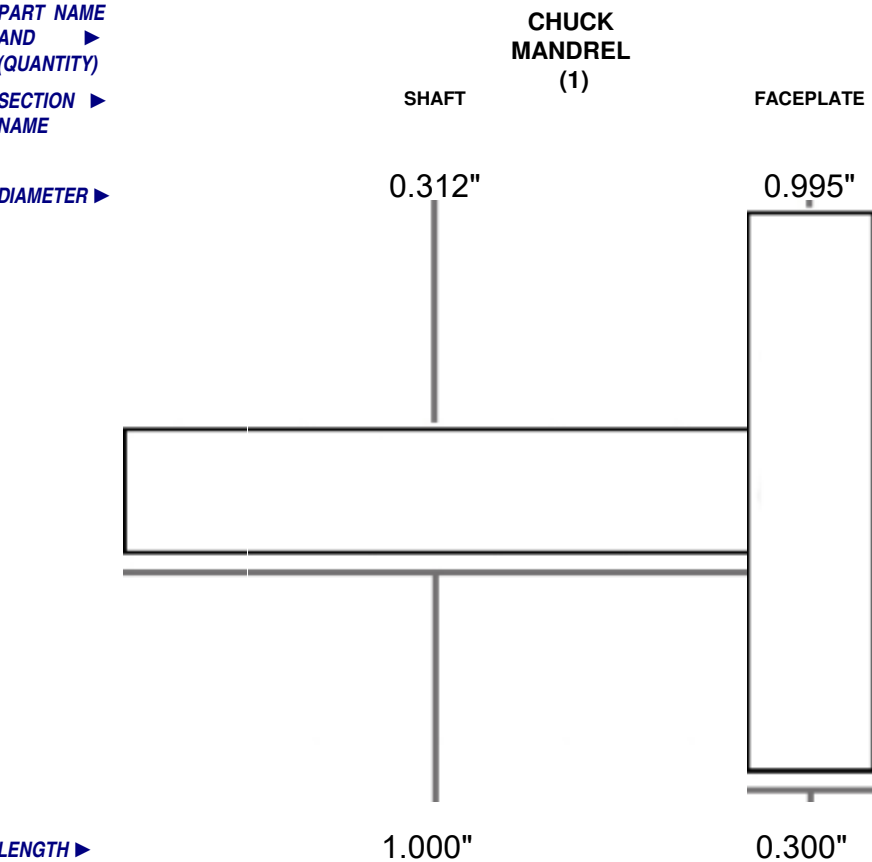

ASSOCIATED BS21(XX), BS22(XX), BS23S(XX), BS24S(XX), PKMGH(XX)
KITS:

PICTURE IS AN APPROXIMATE REPRESENTATION. NOT TO EXACT SCALE OR PROPORTION. ALL MEASUREMENTS IN INCHES. BUSHING DIAMETERS (TOP ROW) ARE OPTIMAL AND SHOULD VARY BY NO MORE THAN .002" WHEN NEW.

ID NUMBER PKDCMPT
NUMBER OF PARTS 1
THRU HOLE NONE

TYPE: DRILL CHUCK MANDREL

NOTES: FITS IN HEADSTOCK MOUNTED DRILL CHUCK

PART NAME AND (QUANTITY)
SECTION NAME

DIAMETER

LENGTH

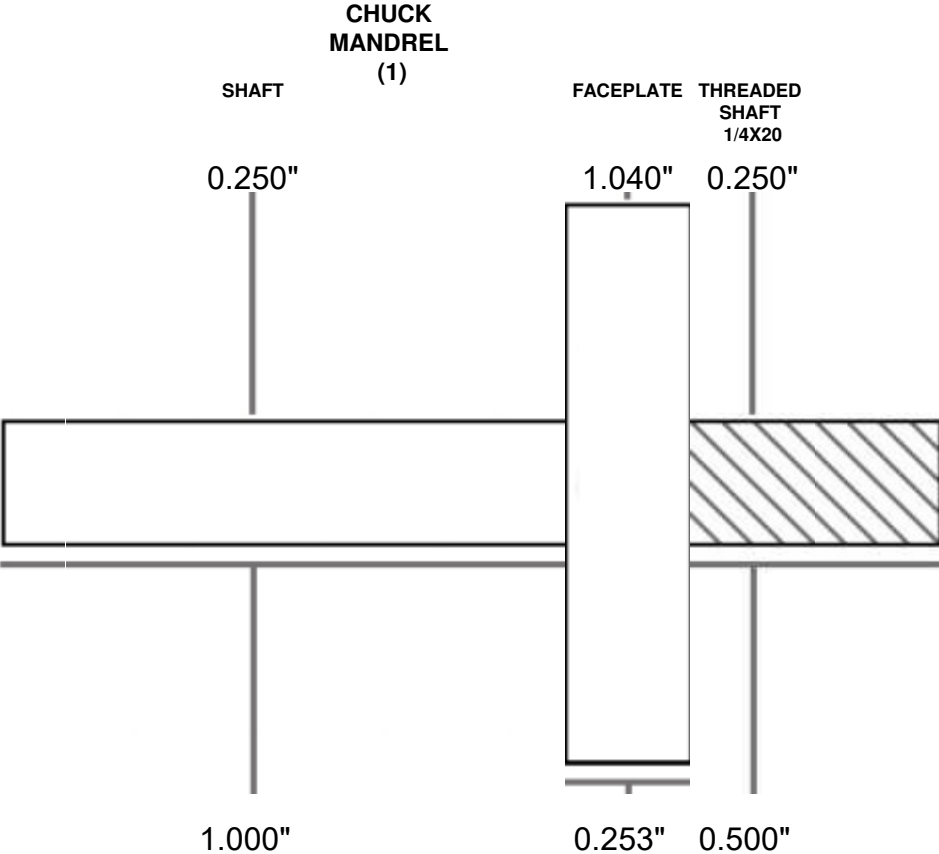

ASSOCIATED PKGRINDPT(XX)
KITS:

PICTURE IS AN APPROXIMATE REPRESENTATION. NOT TO EXACT SCALE OR PROPORTION. ALL MEASUREMENTS IN INCHES. BUSHING DIAMETERS (TOP ROW) ARE OPTIMAL AND SHOULD VARY BY NO MORE THAN .002" WHEN NEW.

ID NUMBER PKDET2BU **TYPE:** BUSHING

NUMBER OF PARTS 2

THRU HOLE STANDARD (0.248')

NOTES: NOTE THAT LONGER SIDE IS LARGER DIAMETER. THIS IS IMPORTANT TO REMEMBER FOR A BETTER MATCH WITH THE DIAMETER OF THE CLIP SECTION.

PART NAME AND (QUANTITY)

SECTION NAME

DIAMETER

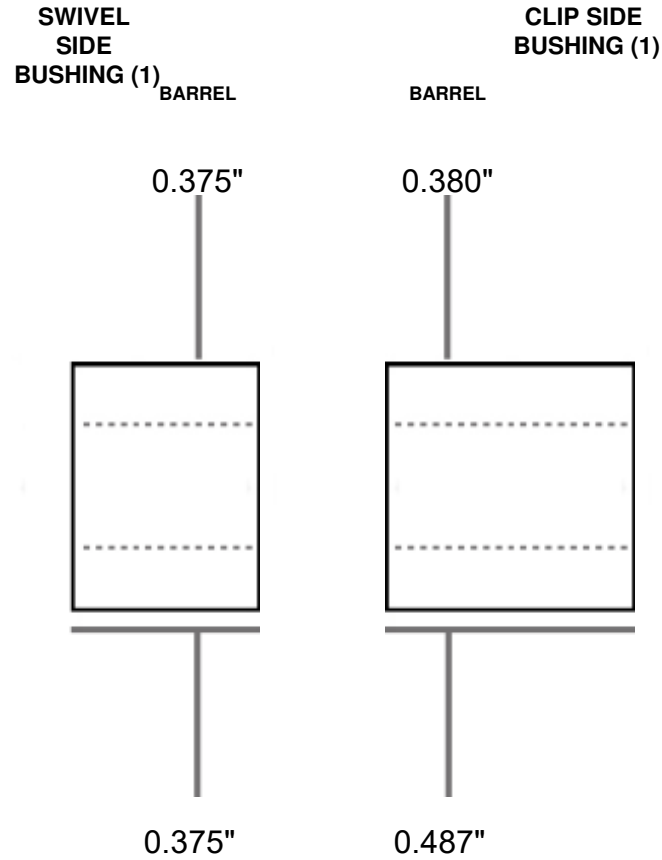

LENGTH

ASSOCIATED PKDET2(XX)

KITS:

PICTURE IS AN APPROXIMATE REPRESENTATION. NOT TO EXACT SCALE OR PROPORTION. ALL MEASUREMENTS IN INCHES. BUSHING DIAMETERS (TOP ROW) ARE OPTIMAL AND SHOULD VARY BY NO MORE THAN .002" WHEN NEW.

ID NUMBER PKDRABU

TYPE: BUSHING

NOTES:

NUMBER OF PARTS 3

THRU HOLE STANDARD (0.248")

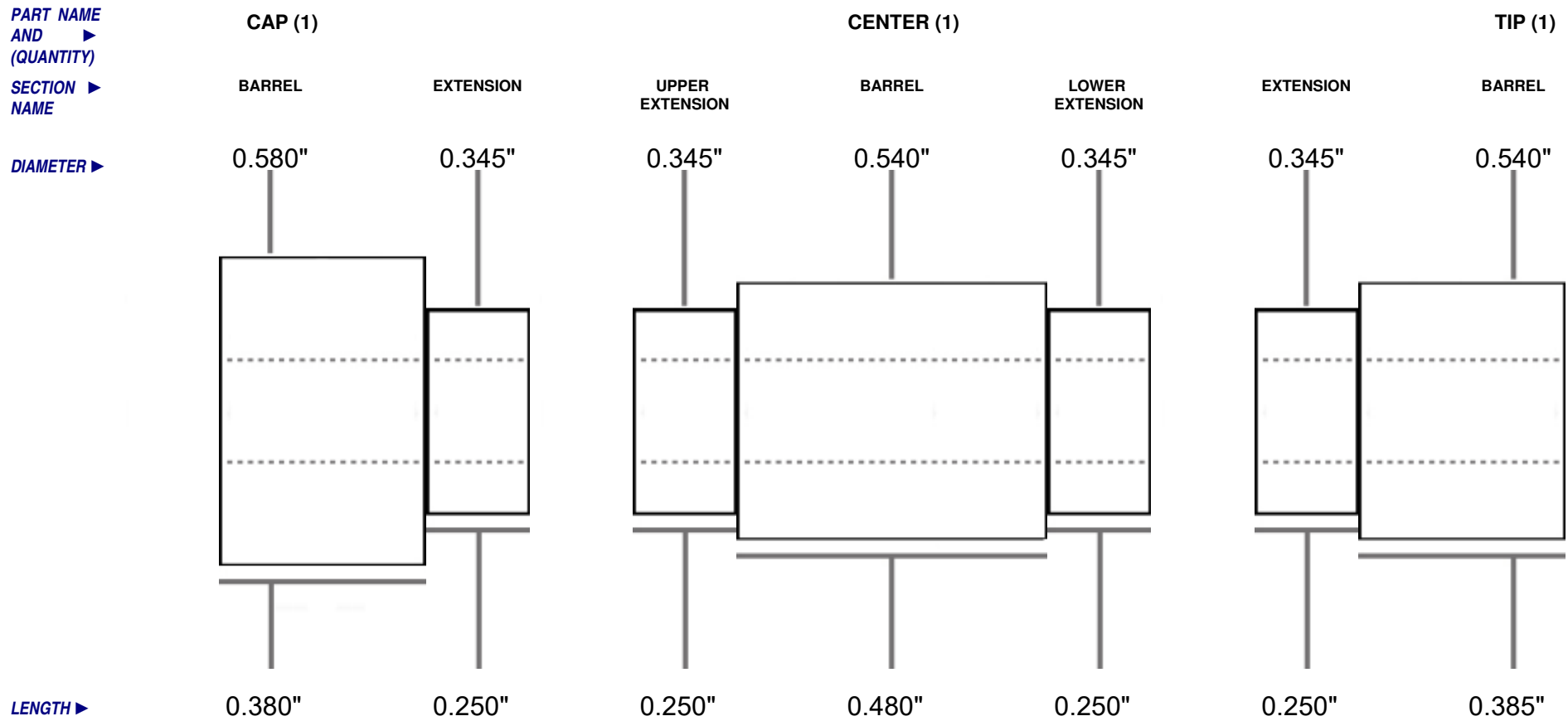

ASSOCIATED PKDRA(XX)

KITS:

PICTURE IS AN APPROXIMATE REPRESENTATION. NOT TO EXACT SCALE OR PROPORTION. ALL MEASUREMENTS IN INCHES. BUSHING DIAMETERS (TOP ROW) ARE OPTIMAL AND SHOULD VARY BY NO MORE THAN .002" WHEN NEW.

ID NUMBER PKDRIP7BU **TYPE:** BUSHING

NOTES: BOTH SIDES HAVE SAME DIAMETERS

NUMBER OF PARTS 2

THRU HOLE STANDARD (0.248')

PART NAME AND (QUANTITY)

SECTION NAME

DIAMETER

END BUSHINGS (2) BARREL

0.393"

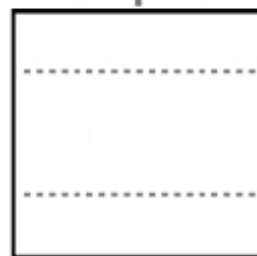

0.437"

LENGTH

ASSOCIATED KITS: PKDRIP7(XX)

PICTURE IS AN APPROXIMATE REPRESENTATION. NOT TO EXACT SCALE OR PROPORTION. ALL MEASUREMENTS IN INCHES. BUSHING DIAMETERS (TOP ROW) ARE OPTIMAL AND SHOULD VARY BY NO MORE THAN .002" WHEN NEW.

ID NUMBER PKDRIP8BU **TYPE:** BUSHING

NOTES: BOTH SIDES HAVE SAME DIAMETER

NUMBER OF PARTS 2

THRU HOLE STANDARD (0.248')

PART NAME AND (QUANTITY)

SECTION NAME

DIAMETER

LENGTH

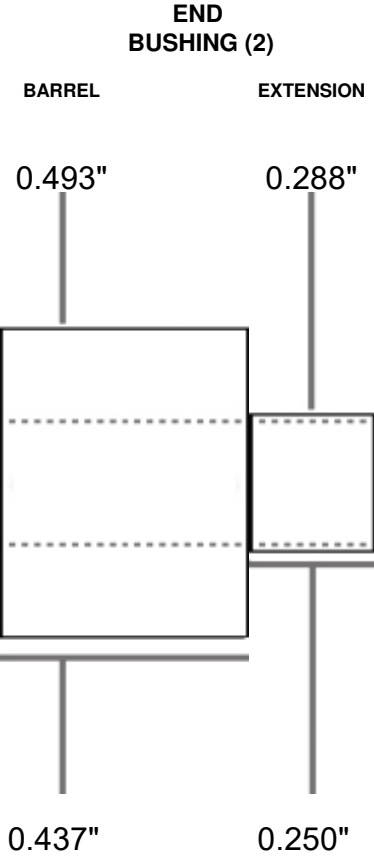

ASSOCIATED PKDRIP8(XX)
KITS:

PICTURE IS AN APPROXIMATE REPRESENTATION. NOT TO EXACT SCALE OR PROPORTION. ALL MEASUREMENTS IN INCHES. BUSHING DIAMETERS (TOP ROW) ARE OPTIMAL AND SHOULD VARY BY NO MORE THAN .002" WHEN NEW.

ID NUMBER PKDRRBU

TYPE: BUSHING

NOTES:

NUMBER OF PARTS 3

THRU HOLE STANDARD (0.248')

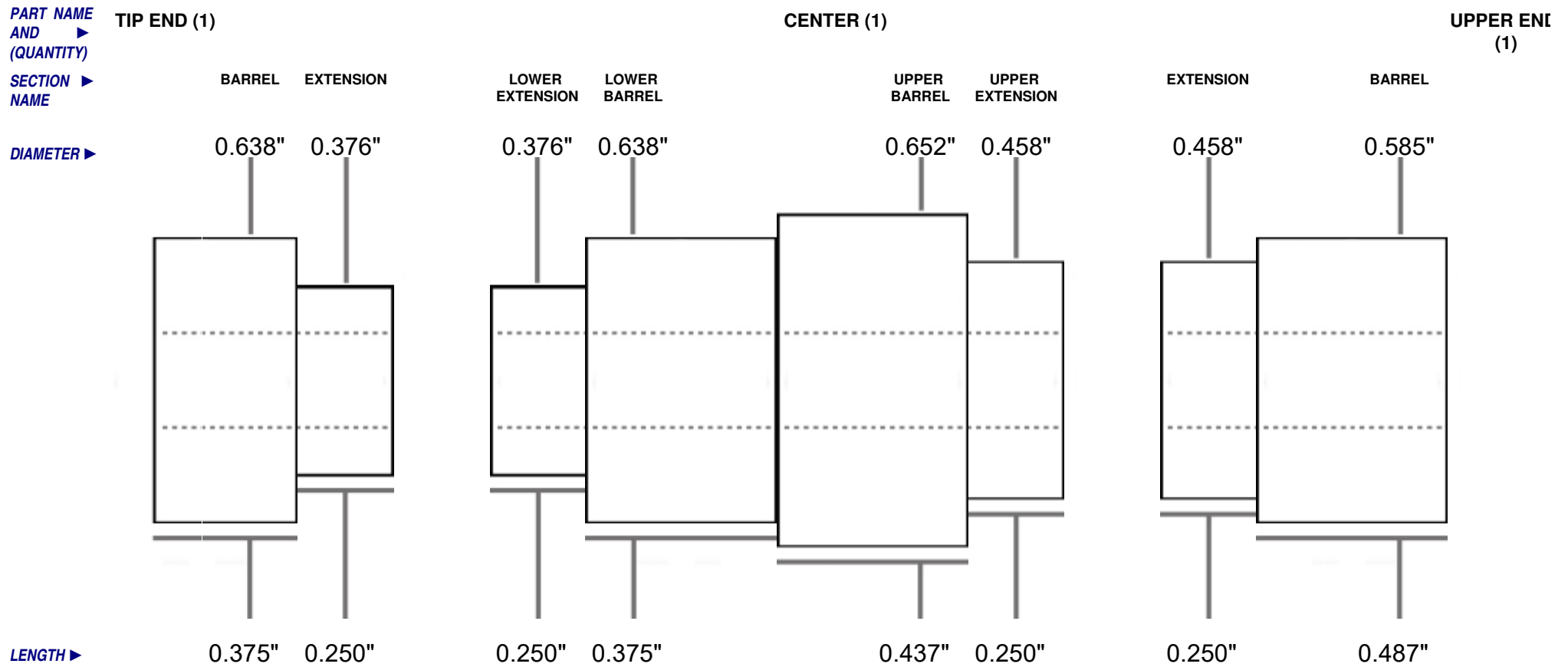

ASSOCIATED PKDRF(XX), PKDRR(XX)

KITS:

PICTURE IS AN APPROXIMATE REPRESENTATION. NOT TO EXACT SCALE OR PROPORTION. ALL MEASUREMENTS IN INCHES. BUSHING DIAMETERS (TOP ROW) ARE OPTIMAL AND SHOULD VARY BY NO MORE THAN .002" WHEN NEW.

ID NUMBER PKDSTYBU **TYPE:** BUSHING

NOTES: ALL THREE PARTS HAVE SAME DIMENSIONS.

NUMBER OF PARTS 3

THRU HOLE STANDARD (0.248')

**PART NAME
AND ►
(QUANTITY)**

**SECTION ►
NAME**

DIAMETER ►

**CENTER/EN
D (3)**

BARREL

0.420"

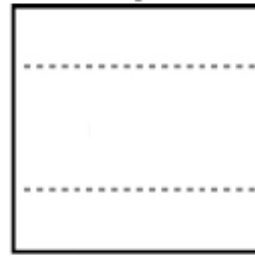

0.375"

LENGTH ►

ASSOCIATED PKDSTY(XX)

KITS:

PICTURE IS AN APPROXIMATE REPRESENTATION. NOT TO EXACT SCALE OR PROPORTION. ALL MEASUREMENTS IN INCHES. BUSHING DIAMETERS (TOP ROW) ARE OPTIMAL AND SHOULD VARY BY NO MORE THAN .002" WHEN NEW.

ID NUMBER PKDUSLIMBU **TYPE:** BUSHING

NOTES: ALL THREE BUSHINGS ARE THE SAME SIZE.

NUMBER OF PARTS 0

THRU HOLE STANDARD (0.248')

PART NAME AND (QUANTITY)

BUSHING (3)

SECTION NAME

BARREL

DIAMETER

0.350"



LENGTH

0.400"

ASSOCIATED KITS: PKDUSLIM(XX)

PICTURE IS AN APPROXIMATE REPRESENTATION. NOT TO EXACT SCALE OR PROPORTION. ALL MEASUREMENTS IN INCHES. BUSHING DIAMETERS (TOP ROW) ARE OPTIMAL AND SHOULD VARY BY NO MORE THAN .002" WHEN NEW.

ID NUMBER PKDWBU

TYPE: BUSHING

NOTES: ALL THREE PARTS THE SAME

NUMBER OF PARTS 3

THRU HOLE STANDARD (0.248')

PART NAME AND (QUANTITY)

SECTION NAME

DIAMETER

DINING BUSHING (3)

BARREL

0.435"



0.437"

LENGTH

ASSOCIATED KITS: PKDWE(XX), PKDWF(XX), PKDWG(XX), PKDWH(XX), PKDWJ(XX), PKDWK(XX), PKDWL(XX)

PICTURE IS AN APPROXIMATE REPRESENTATION. NOT TO EXACT SCALE OR PROPORTION. ALL MEASUREMENTS IN INCHES. BUSHING DIAMETERS (TOP ROW) ARE OPTIMAL AND SHOULD VARY BY NO MORE THAN .002" WHEN NEW.

ID NUMBER PKEXEC-BU **TYPE:** BUSHING

NOTES: BOTH SIDES HAVE SAME DIMENSION

NUMBER OF PARTS 2

THRU HOLE STANDARD(0.248")

PART NAME AND (QUANTITY)

SECTION NAME

DIAMETER

LENGTH

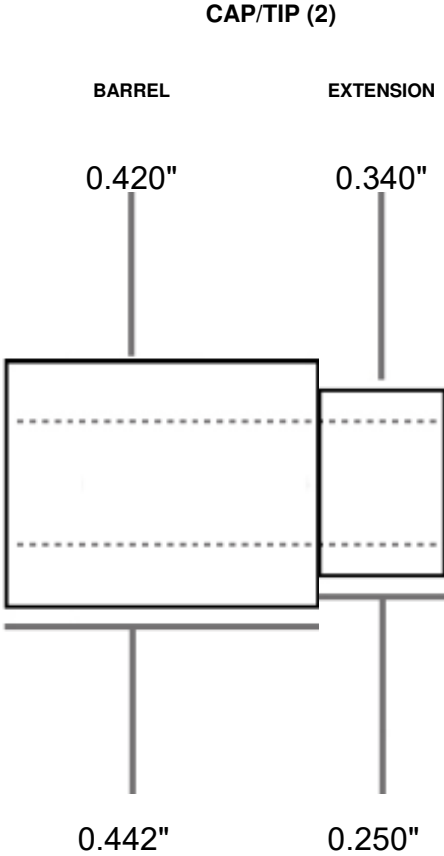

ASSOCIATED MCM-EX(XX), PKBFPCLCH(XX), PKEXEC-PCL(XX), PKEXEC-PEN(XX), PKEXECST(XX)
KITS:

PICTURE IS AN APPROXIMATE REPRESENTATION. NOT TO EXACT SCALE OR PROPORTION. ALL MEASUREMENTS IN INCHES. BUSHING DIAMETERS (TOP ROW) ARE OPTIMAL AND SHOULD VARY BY NO MORE THAN .002" WHEN NEW.

ID NUMBER PKEXECRBU **TYPE:** BUSHING

NOTES:

NUMBER OF PARTS 3

THRU HOLE STANDARD (0.248')

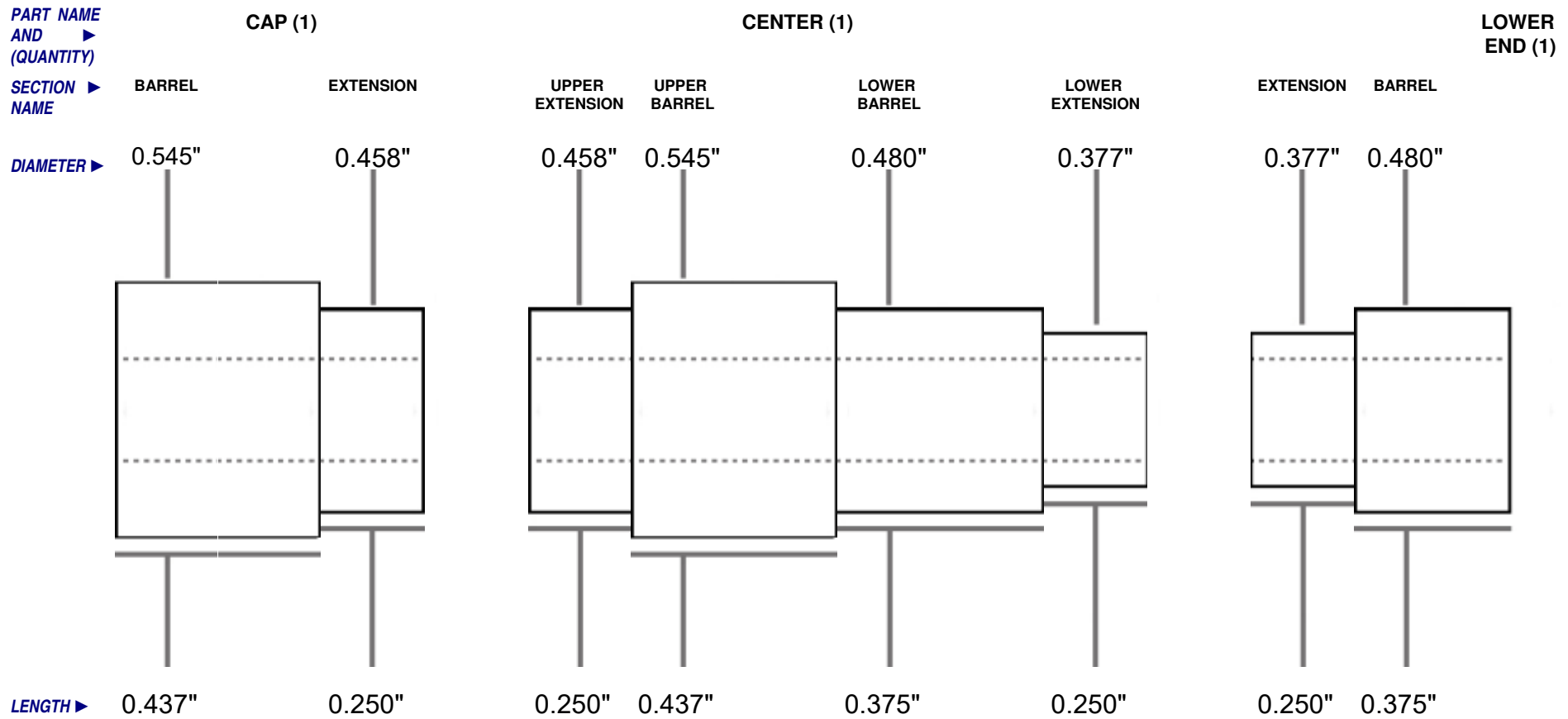

ASSOCIATED PKEXECF(XX), PKEXECR(XX), PKGAPF(XX), PKGAPR(XX)

KITS:

PICTURE IS AN APPROXIMATE REPRESENTATION. NOT TO EXACT SCALE OR PROPORTION. ALL MEASUREMENTS IN INCHES. BUSHING DIAMETERS (TOP ROW) ARE OPTIMAL AND SHOULD VARY BY NO MORE THAN .002" WHEN NEW.

ID NUMBER PKEZBU

TYPE: BUSHING

NOTES:

NUMBER OF PARTS 4

THRU HOLE STANDARD (0.248')

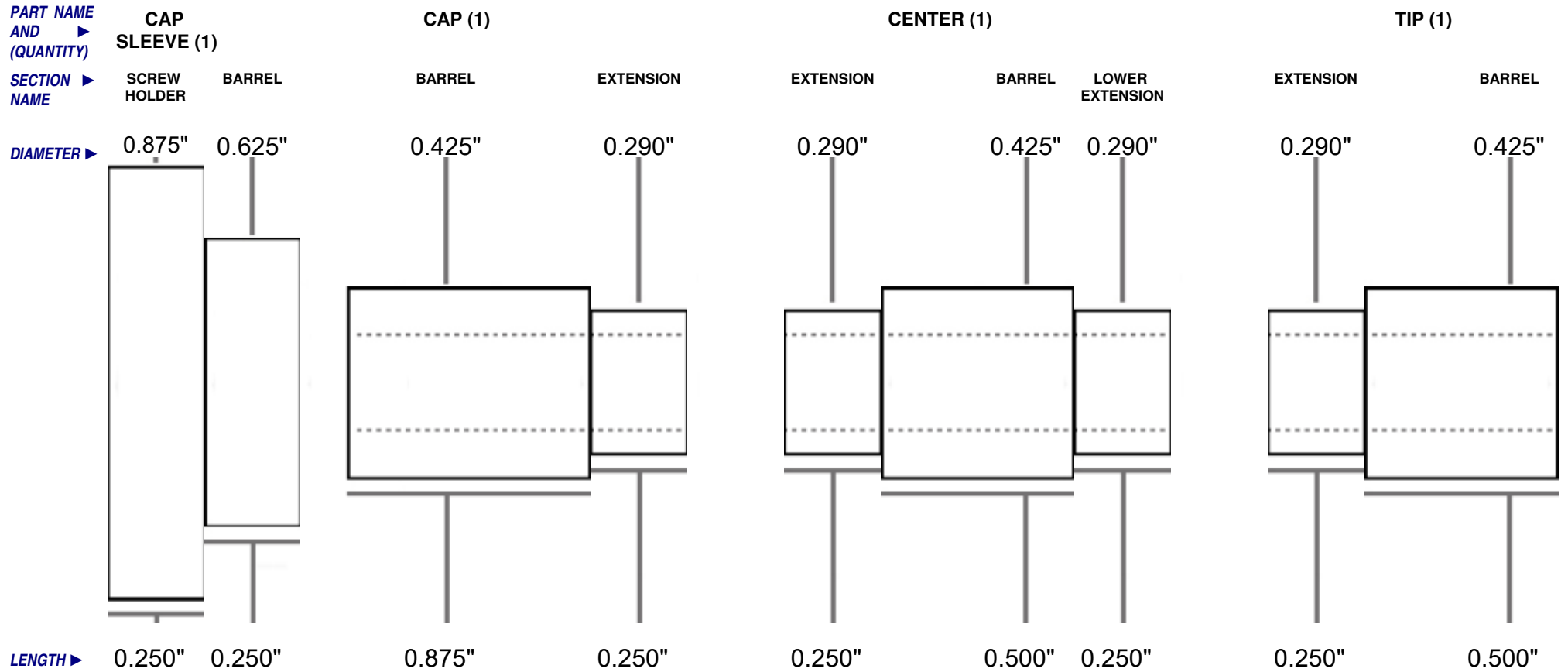

ASSOCIATED PKEZPEN(XX)

KITS:

PICTURE IS AN APPROXIMATE REPRESENTATION. NOT TO EXACT SCALE OR PROPORTION. ALL MEASUREMENTS IN INCHES. BUSHING DIAMETERS (TOP ROW) ARE OPTIMAL AND SHOULD VARY BY NO MORE THAN .002" WHEN NEW.

ID NUMBER PKFBALLBU **TYPE:**

NOTES:

NUMBER OF PARTS 3

THRU HOLE STANDARD (0.248')

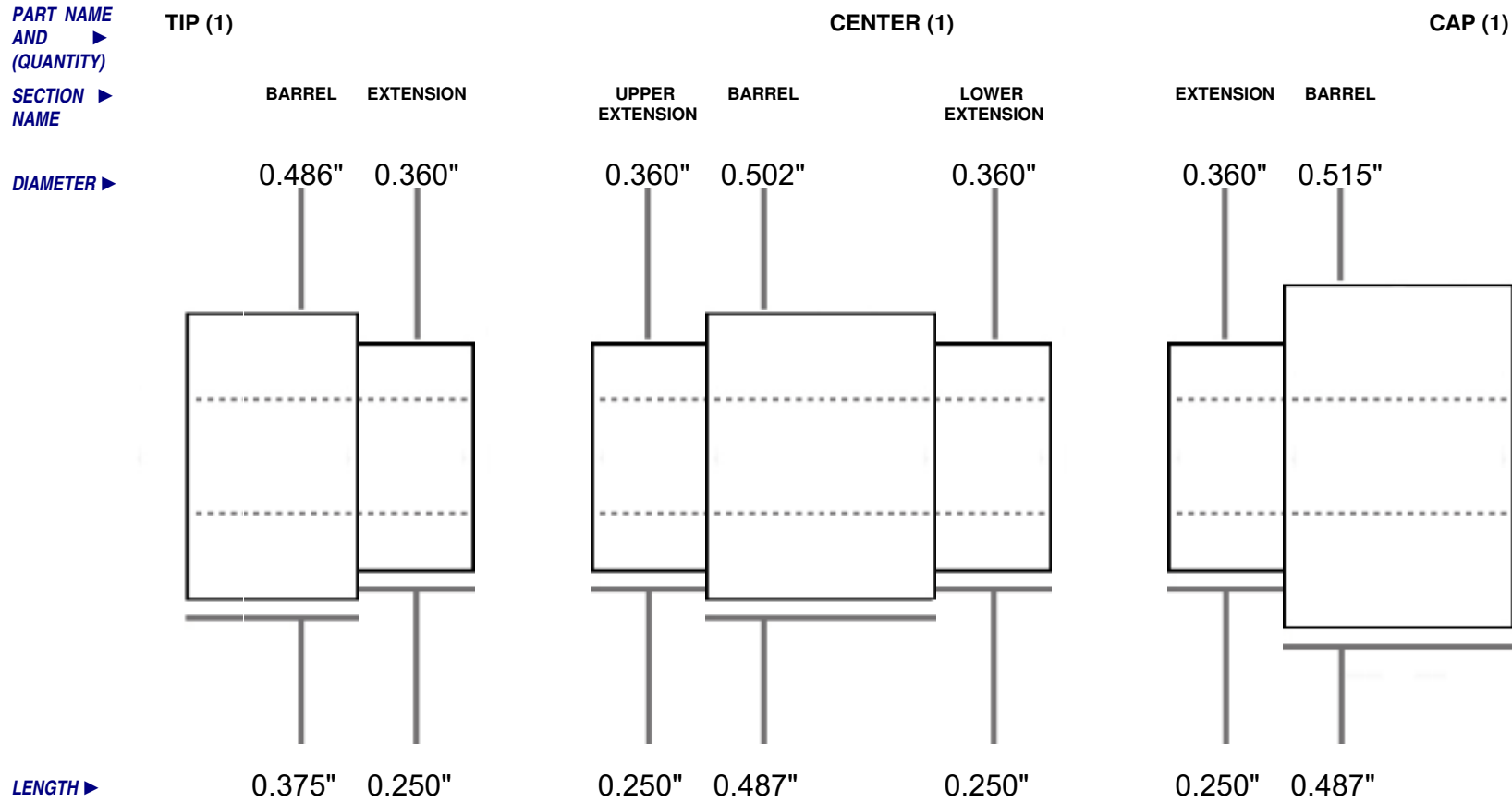

ASSOCIATED PKFBALL(XX)

KITS:

PICTURE IS AN APPROXIMATE REPRESENTATION. NOT TO EXACT SCALE OR PROPORTION. ALL MEASUREMENTS IN INCHES. BUSHING DIAMETERS (TOP ROW) ARE OPTIMAL AND SHOULD VARY BY NO MORE THAN .002" WHEN NEW.

ID NUMBER PKFCBU **TYPE:** BUSHING
NUMBER OF PARTS 3

NOTES: END BUSHINGS HAVE SAME DIMENSION. COMES WITH TRIM SLEEVE.

THRU HOLE STANDARD (0.248") ON BUSHINGS .355" ON TRIM SLEEVE

PART NAME AND (QUANTITY)
SECTION NAME

END BUSHINGS (2)
BARREL EXTENSION

TRIM SLEEVE (1)

DIAMETER

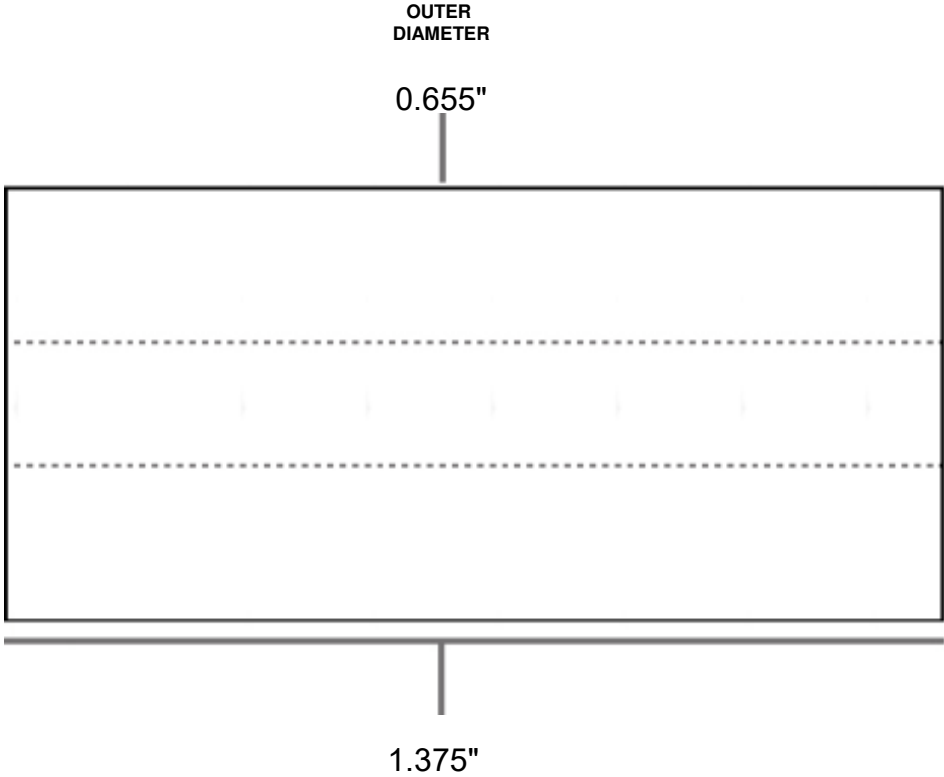
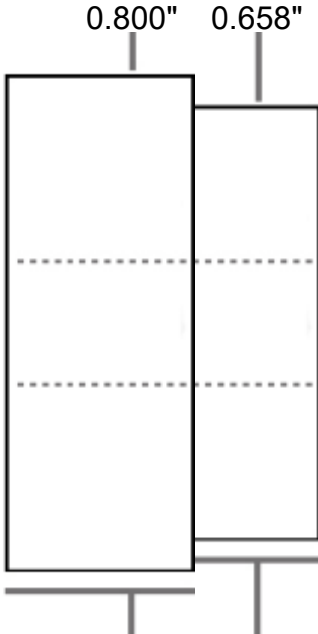

LENGTH

ASSOCIATED KITS: PKFC(XX)

PICTURE IS AN APPROXIMATE REPRESENTATION. NOT TO EXACT SCALE OR PROPORTION. ALL MEASUREMENTS IN INCHES. BUSHING DIAMETERS (TOP ROW) ARE OPTIMAL AND SHOULD VARY BY NO MORE THAN .002" WHEN NEW.

ID NUMBER PKFEDBU

TYPE: BUSHING

NOTES:

NUMBER OF PARTS 2

THRU HOLE STANDARD (0.248")

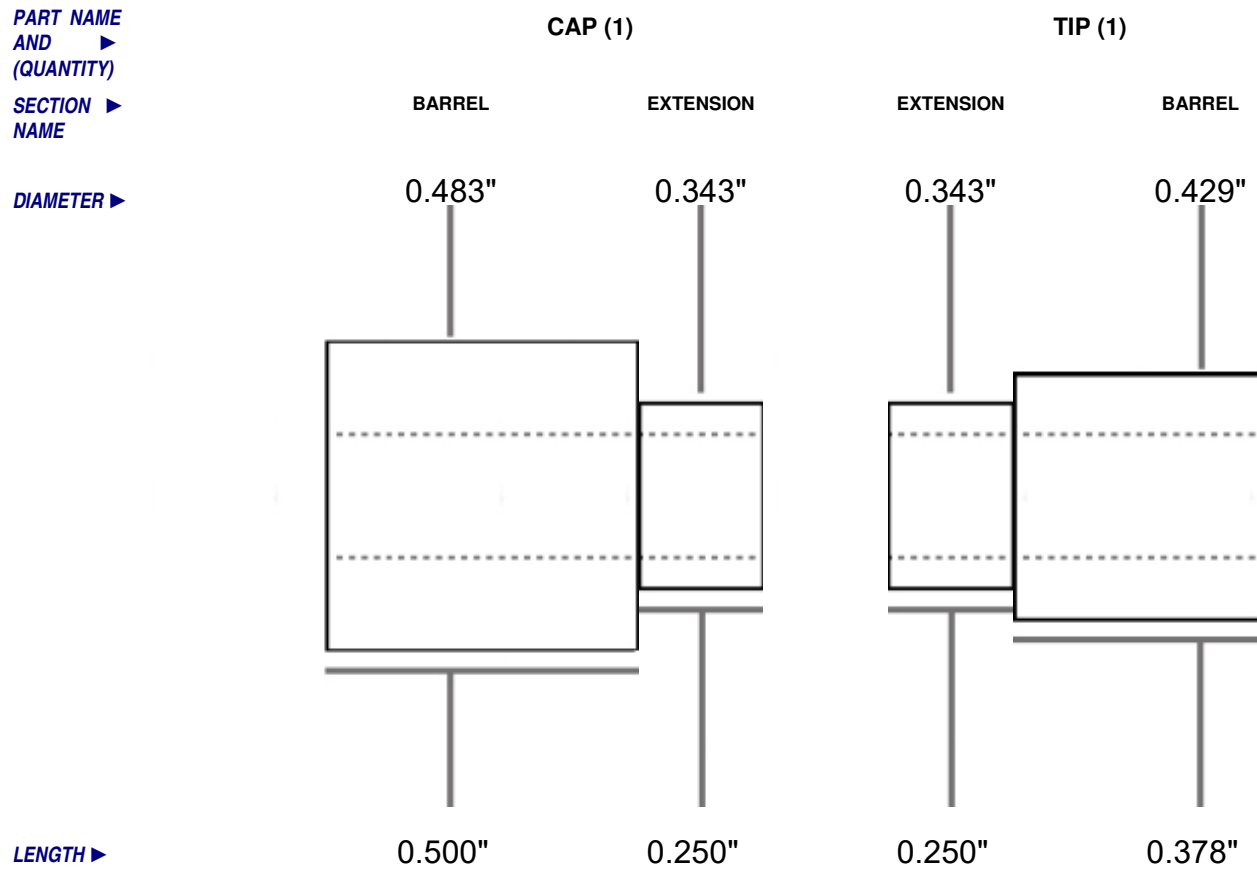

ASSOCIATED PKBIRD(XX), PKFED(XX)

KITS:

PICTURE IS AN APPROXIMATE REPRESENTATION. NOT TO EXACT SCALE OR PROPORTION. ALL MEASUREMENTS IN INCHES. BUSHING DIAMETERS (TOP ROW) ARE OPTIMAL AND SHOULD VARY BY NO MORE THAN .002" WHEN NEW.

ID NUMBER PKFILBU

TYPE: BUSHING

NOTES: BOTH ENDS SAME MEASUREMENTS

NUMBER OF PARTS 2

THRU HOLE STANDARD (0.248')

PART NAME AND (QUANTITY)

SECTION NAME

DIAMETER

LENGTH

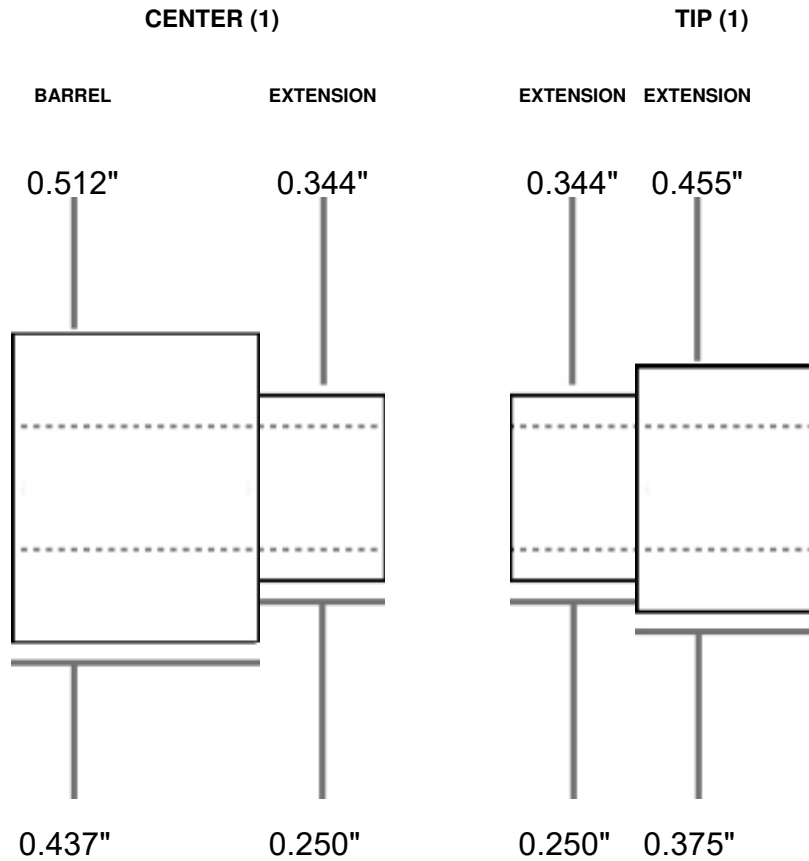

ASSOCIATED PKFIL(XX)

KITS:

PICTURE IS AN APPROXIMATE REPRESENTATION. NOT TO EXACT SCALE OR PROPORTION. ALL MEASUREMENTS IN INCHES. BUSHING DIAMETERS (TOP ROW) ARE OPTIMAL AND SHOULD VARY BY NO MORE THAN .002" WHEN NEW.

ID NUMBER PKFIREBU

TYPE: BUSHING

NOTES:

NUMBER OF PARTS 2

THRU HOLE STANDARD (0.248')

PART NAME AND (QUANTITY)

SECTION NAME

DIAMETER

LENGTH

TIP (1)

CAP (1)

BARREL EXTENSION

EXTENSION BARREL

0.468"

0.360"

0.360"

0.490"

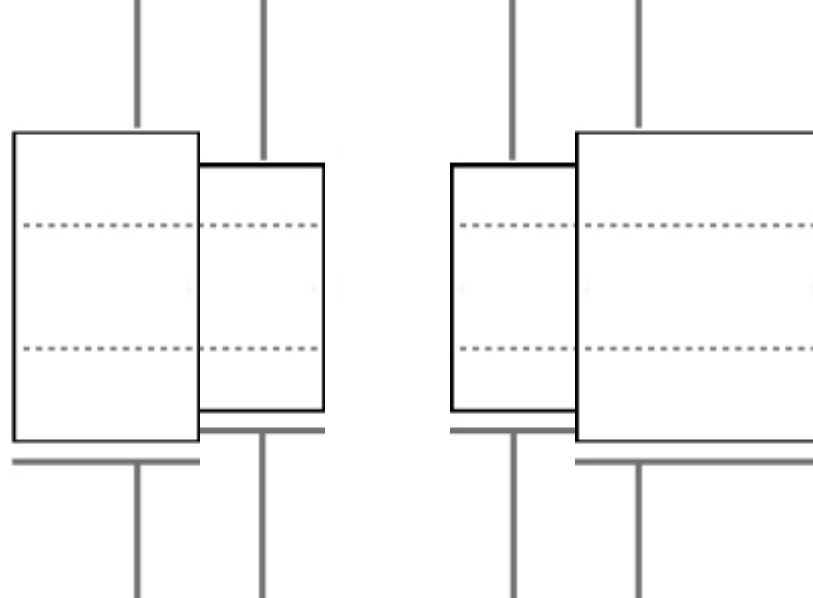

0.375"

0.250"

0.250"

0.487"

ASSOCIATED PKFIRE(XX)

KITS:

PICTURE IS AN APPROXIMATE REPRESENTATION. NOT TO EXACT SCALE OR PROPORTION. ALL MEASUREMENTS IN INCHES. BUSHING DIAMETERS (TOP ROW) ARE OPTIMAL AND SHOULD VARY BY NO MORE THAN .002" WHEN NEW.

ID NUMBER PKFLYRBU

TYPE: BUSHING

NOTES:

NUMBER OF PARTS 3

THRU HOLE STANDARD (0.248')

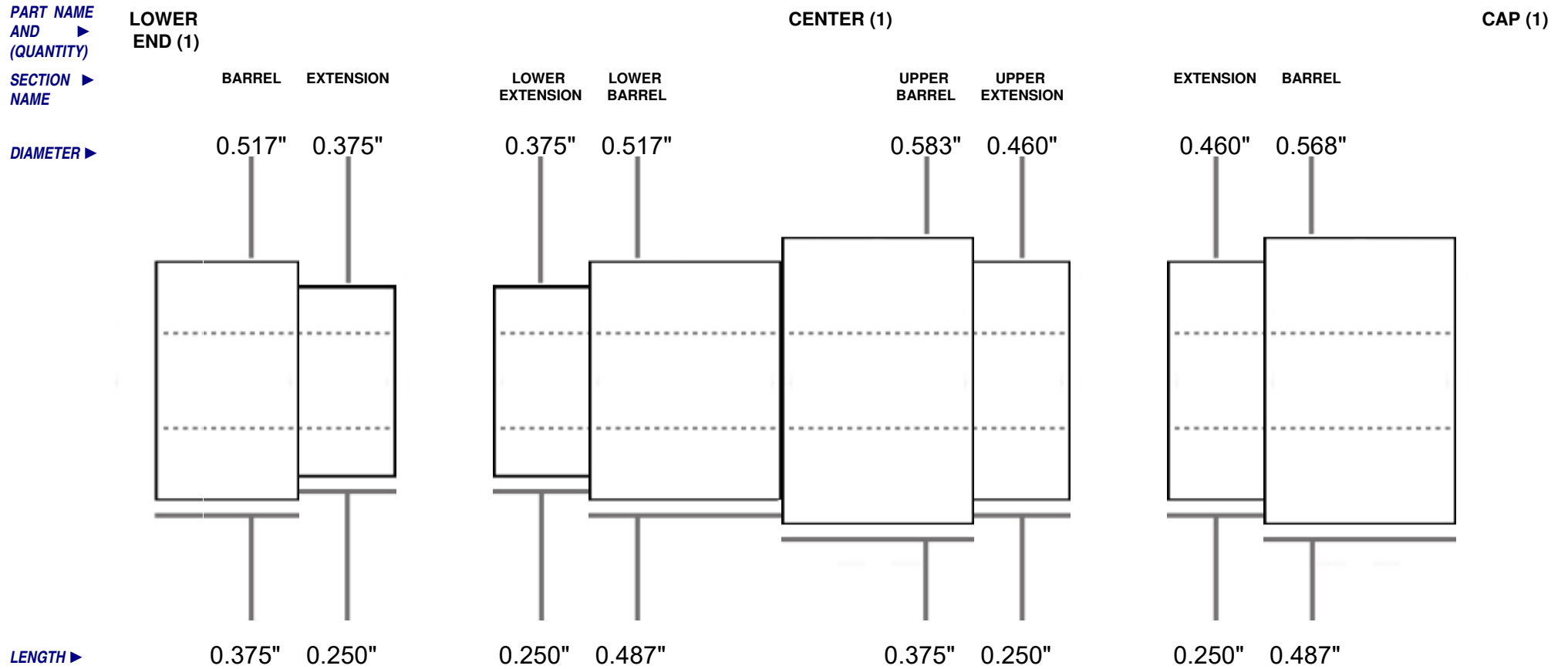

ASSOCIATED PKFLYF(XX), PKFLYR(XX)

KITS:

PICTURE IS AN APPROXIMATE REPRESENTATION. NOT TO EXACT SCALE OR PROPORTION. ALL MEASUREMENTS IN INCHES. BUSHING DIAMETERS (TOP ROW) ARE OPTIMAL AND SHOULD VARY BY NO MORE THAN .002" WHEN NEW.

ID NUMBER PKFP4500BU **TYPE:** BUSHING

NOTES: BOTH END BUSHINGS SAME DIAMETER

NUMBER OF PARTS 2

THRU HOLE STANDARD (0.248')

PART NAME AND (QUANTITY)

SECTION NAME

DIAMETER

END BUSHING (2)
BARREL EXTENSION

0.494" 0.360"

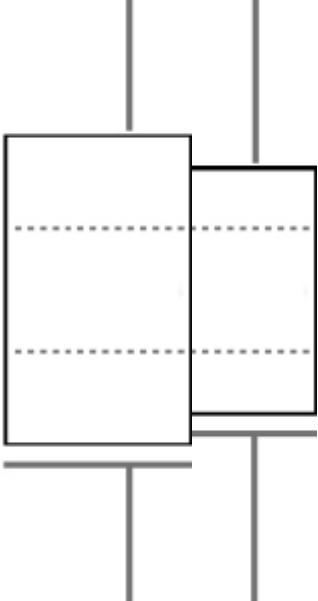

0.375" 0.250"

LENGTH

ASSOCIATED PKFP45(XX)
KITS:

PICTURE IS AN APPROXIMATE REPRESENTATION. NOT TO EXACT SCALE OR PROPORTION. ALL MEASUREMENTS IN INCHES. BUSHING DIAMETERS (TOP ROW) ARE OPTIMAL AND SHOULD VARY BY NO MORE THAN .002" WHEN NEW.

ID NUMBER PKFP5000BU **TYPE:** BUSHING

NOTES: BOTH SIDES ARE THE SAME DIMENSION

NUMBER OF PARTS 2

THRU HOLE STANDARD(0.248")

PART NAME AND (QUANTITY)

SECTION NAME

DIAMETER

LENGTH

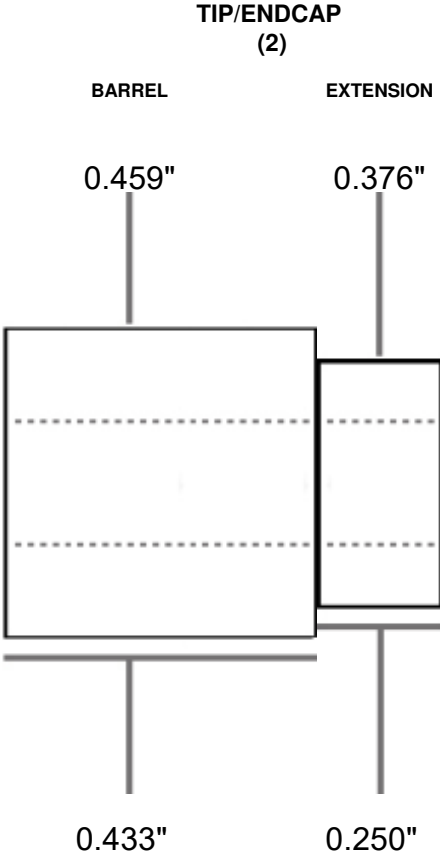

ASSOCIATED PKFP50(XX), PKFP51(XX)
KITS:

PICTURE IS AN APPROXIMATE REPRESENTATION. NOT TO EXACT SCALE OR PROPORTION. ALL MEASUREMENTS IN INCHES. BUSHING DIAMETERS (TOP ROW) ARE OPTIMAL AND SHOULD VARY BY NO MORE THAN .002" WHEN NEW.

ID NUMBER PKFPBU

TYPE: BUSHING

NOTES: BOTH SIDES ARE THE SAME

NUMBER OF PARTS 2

THRU HOLE STANDARD(0.248")

PART NAME AND (QUANTITY)

SECTION NAME

DIAMETER

LENGTH

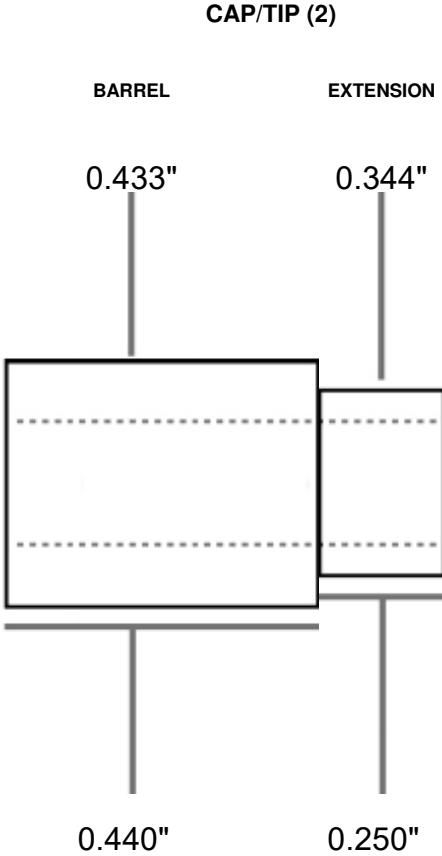

ASSOCIATED PKFLIP2(XX), PKFP40(XX), PKFP41(XX), PKMPL(XX) KITS:

PICTURE IS AN APPROXIMATE REPRESENTATION. NOT TO EXACT SCALE OR PROPORTION. ALL MEASUREMENTS IN INCHES. BUSHING DIAMETERS (TOP ROW) ARE OPTIMAL AND SHOULD VARY BY NO MORE THAN .002" WHEN NEW.

ID NUMBER PKFPENBU

TYPE: BUSHING

NOTES:

NUMBER OF PARTS 3

THRU HOLE STANDARD(0.248")

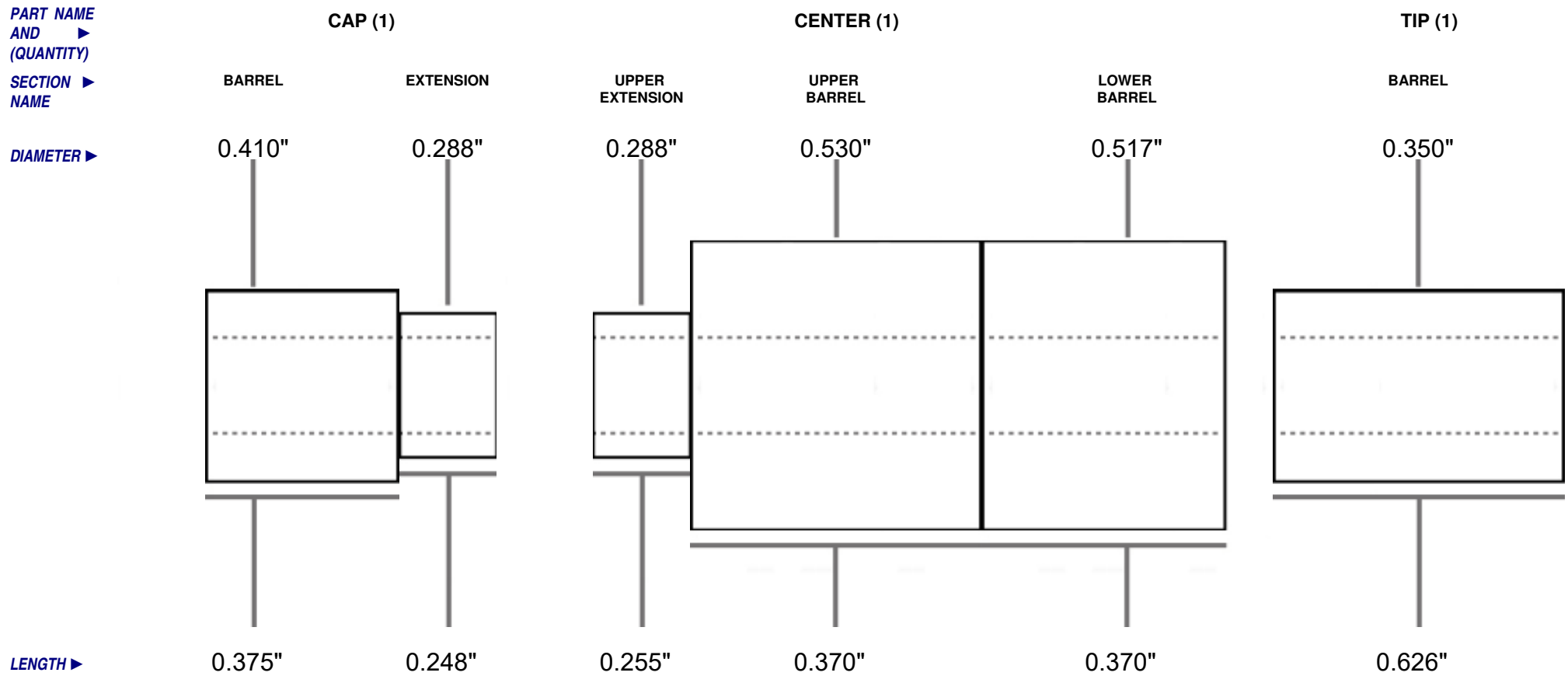

ASSOCIATED PKFPEN(XX)

KITS:

PICTURE IS AN APPROXIMATE REPRESENTATION. NOT TO EXACT SCALE OR PROPORTION. ALL MEASUREMENTS IN INCHES. BUSHING DIAMETERS (TOP ROW) ARE OPTIMAL AND SHOULD VARY BY NO MORE THAN .002" WHEN NEW.

ID NUMBER PKGABTS

TYPE: TRIMMING SLEEVE

NOTES: FITS STANDARD TUBES SIZED 27/64"

NUMBER OF PARTS 1

THRU HOLE ACCEPTS 7MM TRIMMER SHAFT

PART NAME AND (QUANTITY)

TRIMMER SLEEVE (1)

SECTION NAME

BARREL

DIAMETER

0.385"



LENGTH

2.128"

ASSOCIATED KITS:

PICTURE IS AN APPROXIMATE REPRESENTATION. NOT TO EXACT SCALE OR PROPORTION. ALL MEASUREMENTS IN INCHES. BUSHING DIAMETERS (TOP ROW) ARE OPTIMAL AND SHOULD VARY BY NO MORE THAN .002" WHEN NEW.

ID NUMBER PKGABU

TYPE: BUSHING

NOTES: BOTH BUSHINGS SAME SIZE

NUMBER OF PARTS 2

THRU HOLE STANDARD(0.248")

PART NAME AND (QUANTITY)

SECTION NAME

DIAMETER

LENGTH

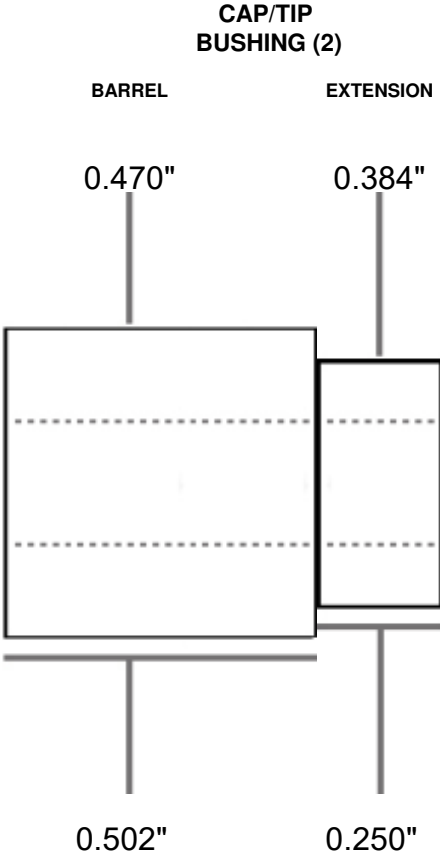

ASSOCIATED PKBROCK(XX), PKGA(XX), PKGAPEN(XX), PKGAPENC(XX)
KITS:

PICTURE IS AN APPROXIMATE REPRESENTATION. NOT TO EXACT SCALE OR PROPORTION. ALL MEASUREMENTS IN INCHES. BUSHING DIAMETERS (TOP ROW) ARE OPTIMAL AND SHOULD VARY BY NO MORE THAN .002" WHEN NEW.

ID NUMBER PKGAFBU

TYPE: BUSHING

NOTES: CAP AND TIP BUSHINGS ARE THE SAME

NUMBER OF PARTS 2

THRU HOLE STANDARD(0.248")

PART NAME AND (QUANTITY)

SECTION NAME

DIAMETER

LENGTH

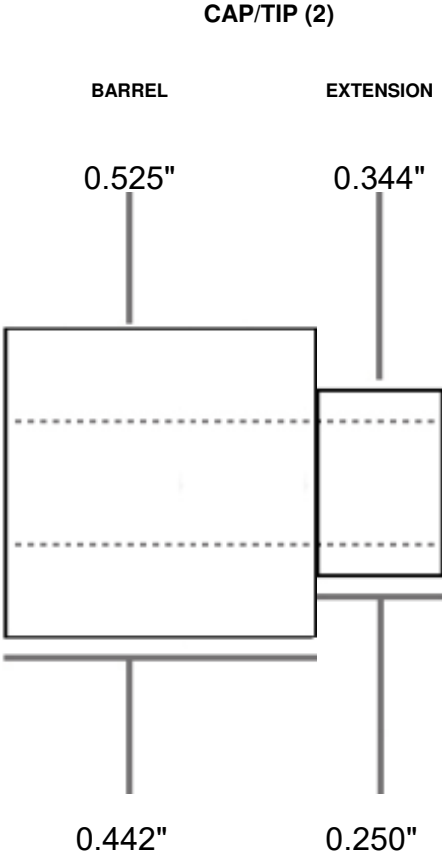

ASSOCIATED PKCPEN(XX), PKGAF(XX), PKMTAG(XX), PKSKEY(XX)
KITS:

PICTURE IS AN APPROXIMATE REPRESENTATION. NOT TO EXACT SCALE OR PROPORTION. ALL MEASUREMENTS IN INCHES. BUSHING DIAMETERS (TOP ROW) ARE OPTIMAL AND SHOULD VARY BY NO MORE THAN .002" WHEN NEW.

ID NUMBER PKGDJRBU **TYPE:** BUSHING

NOTES: BOTH PARTS SAME DIMENSION

NUMBER OF PARTS 2

THRU HOLE STANDARD (0.248')

PART NAME AND (QUANTITY)

SECTION NAME

DIAMETER

LENGTH

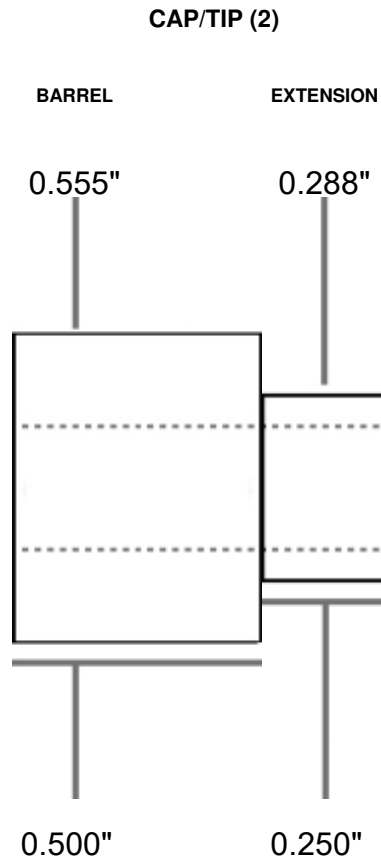

ASSOCIATED PKGDJR(XX)
KITS:

PICTURE IS AN APPROXIMATE REPRESENTATION. NOT TO EXACT SCALE OR PROPORTION. ALL MEASUREMENTS IN INCHES. BUSHING DIAMETERS (TOP ROW) ARE OPTIMAL AND SHOULD VARY BY NO MORE THAN .002" WHEN NEW.

ID NUMBER PKGDPENBU **TYPE:** BUSHING

NOTES: BOTH END BUSHINGS HAVE SAME DIMENSION

NUMBER OF PARTS 2

THRU HOLE STANDARD(0.248")

PART NAME AND (QUANTITY)

SECTION NAME

DIAMETER

LENGTH

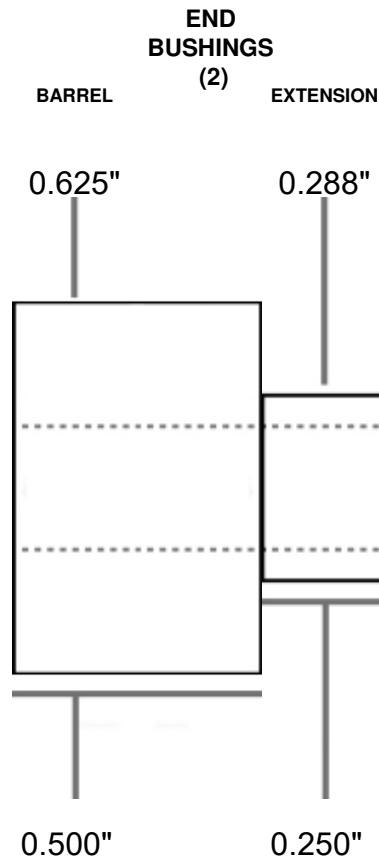

ASSOCIATED PKGDPEN(XX)

KITS:

PICTURE IS AN APPROXIMATE REPRESENTATION. NOT TO EXACT SCALE OR PROPORTION. ALL MEASUREMENTS IN INCHES. BUSHING DIAMETERS (TOP ROW) ARE OPTIMAL AND SHOULD VARY BY NO MORE THAN .002" WHEN NEW.

ID NUMBER PKGDRBBU **TYPE:** BUSHING

NOTES:

NUMBER OF PARTS 3

THRU HOLE STANDARD(0.248")

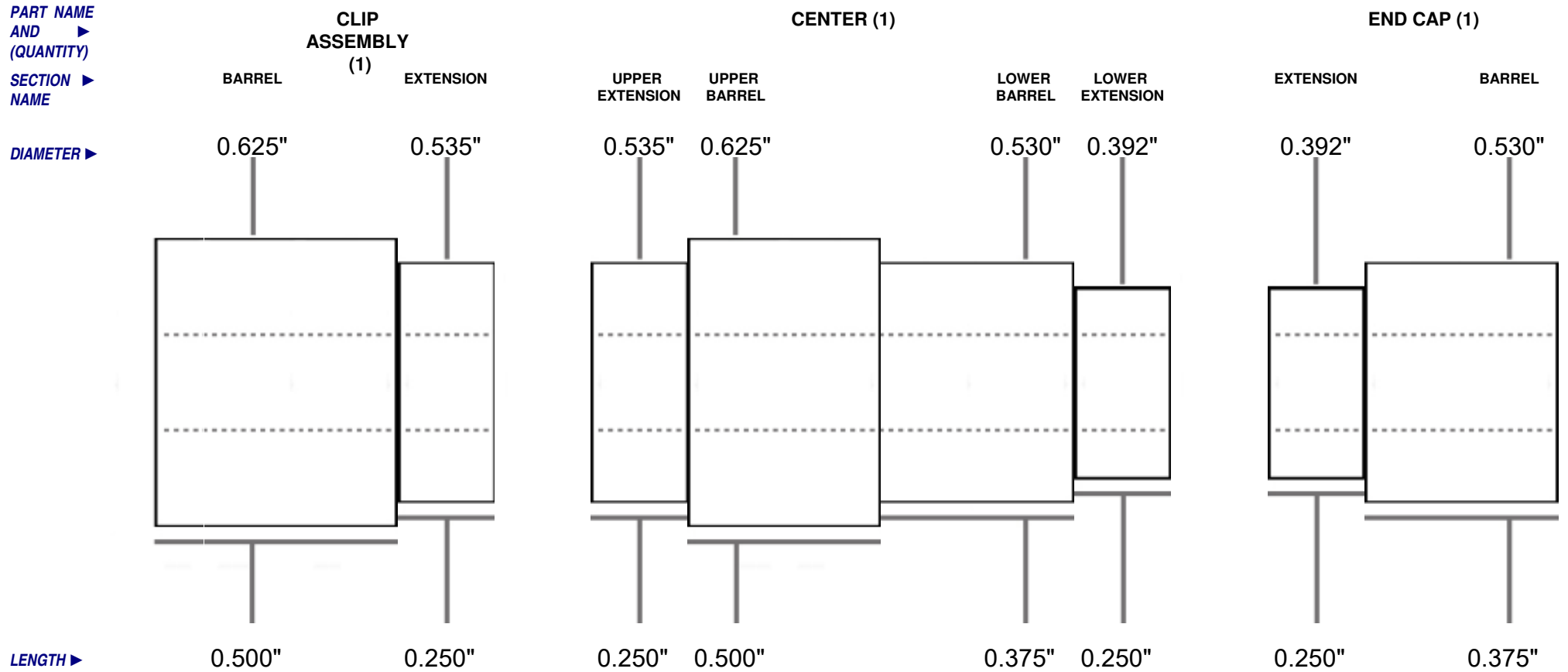

ASSOCIATED PKGDRB(XX)
KITS:

PICTURE IS AN APPROXIMATE REPRESENTATION. NOT TO EXACT SCALE OR PROPORTION. ALL MEASUREMENTS IN INCHES. BUSHING DIAMETERS (TOP ROW) ARE OPTIMAL AND SHOULD VARY BY NO MORE THAN .002" WHEN NEW.

ID NUMBER PKGDRBTS **TYPE:** TRIMMING SLEEVE
NUMBER OF PARTS 2

NOTES: FITS STANDARD TUBES SIZED 9/16" (UPPER) AND 27/64" (LOWER)

THRU HOLE ACCEPTS 7MM TRIMMER SHAFT

PART NAME AND (QUANTITY)

SECTION NAME

DIAMETER

UPPER SLEEVE (1)

EXTENSION

0.533"



1.250"

LENGTH

LOWER SLEEVE (1)

EXTENSION

0.389"



1.626"

ASSOCIATED KITS:

PICTURE IS AN APPROXIMATE REPRESENTATION. NOT TO EXACT SCALE OR PROPORTION. ALL MEASUREMENTS IN INCHES. BUSHING DIAMETERS (TOP ROW) ARE OPTIMAL AND SHOULD VARY BY NO MORE THAN .002" WHEN NEW.

ID NUMBER PKGOLFBU **TYPE:** BUSHING

NOTES: BOTH SIDES SAME DIMENSION

NUMBER OF PARTS 2

THRU HOLE STANDARD (0.248')

PART NAME AND (QUANTITY)

SECTION NAME

DIAMETER

LENGTH

ASSOCIATED PKGOLF(XX) KITS:

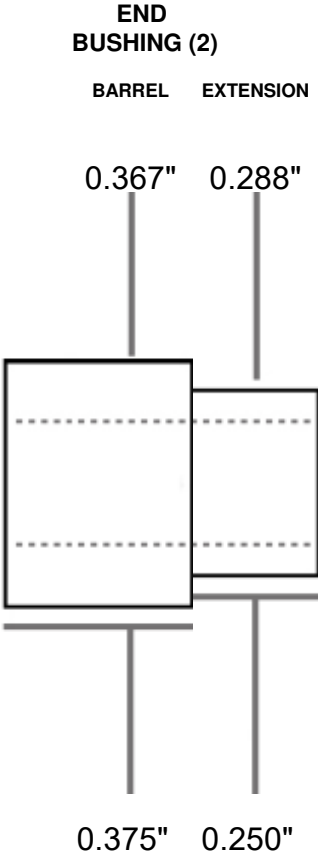

PICTURE IS AN APPROXIMATE REPRESENTATION. NOT TO EXACT SCALE OR PROPORTION. ALL MEASUREMENTS IN INCHES. BUSHING DIAMETERS (TOP ROW) ARE OPTIMAL AND SHOULD VARY BY NO MORE THAN .002" WHEN NEW.

ID NUMBER PKGRAD2BU **TYPE:** BUSHING

NOTES:

NUMBER OF PARTS 3

THRU HOLE STANDARD(0.248")

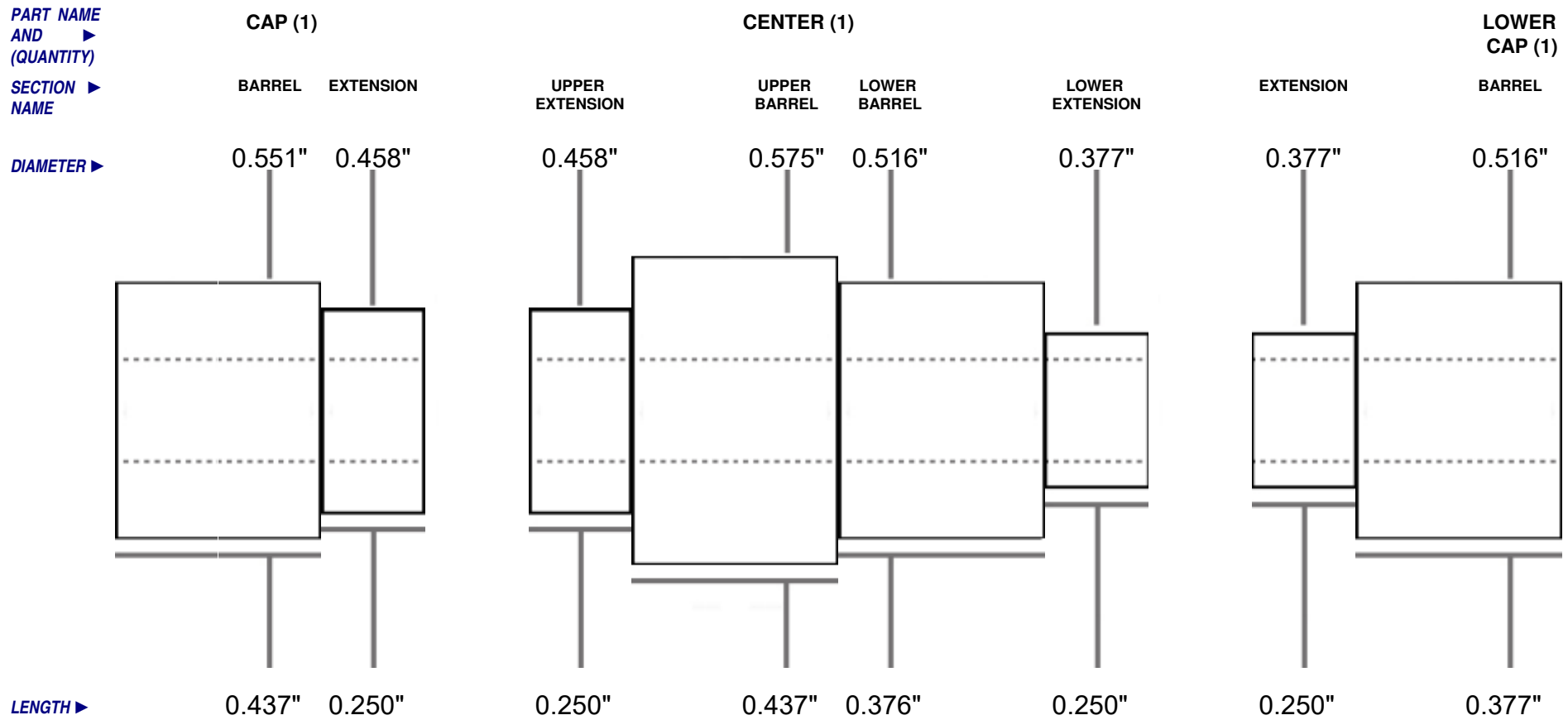

ASSOCIATED PKFP55(XX), PKFP56(XX), PKGRAF(XX), PKGRAR(XX)

KITS:

PICTURE IS AN APPROXIMATE REPRESENTATION. NOT TO EXACT SCALE OR PROPORTION. ALL MEASUREMENTS IN INCHES. BUSHING DIAMETERS (TOP ROW) ARE OPTIMAL AND SHOULD VARY BY NO MORE THAN .002" WHEN NEW.

ID NUMBER PKGRADBU **TYPE:** BUSHING

NOTES:

NUMBER OF PARTS 3

THRU HOLE STANDARD(0.248")

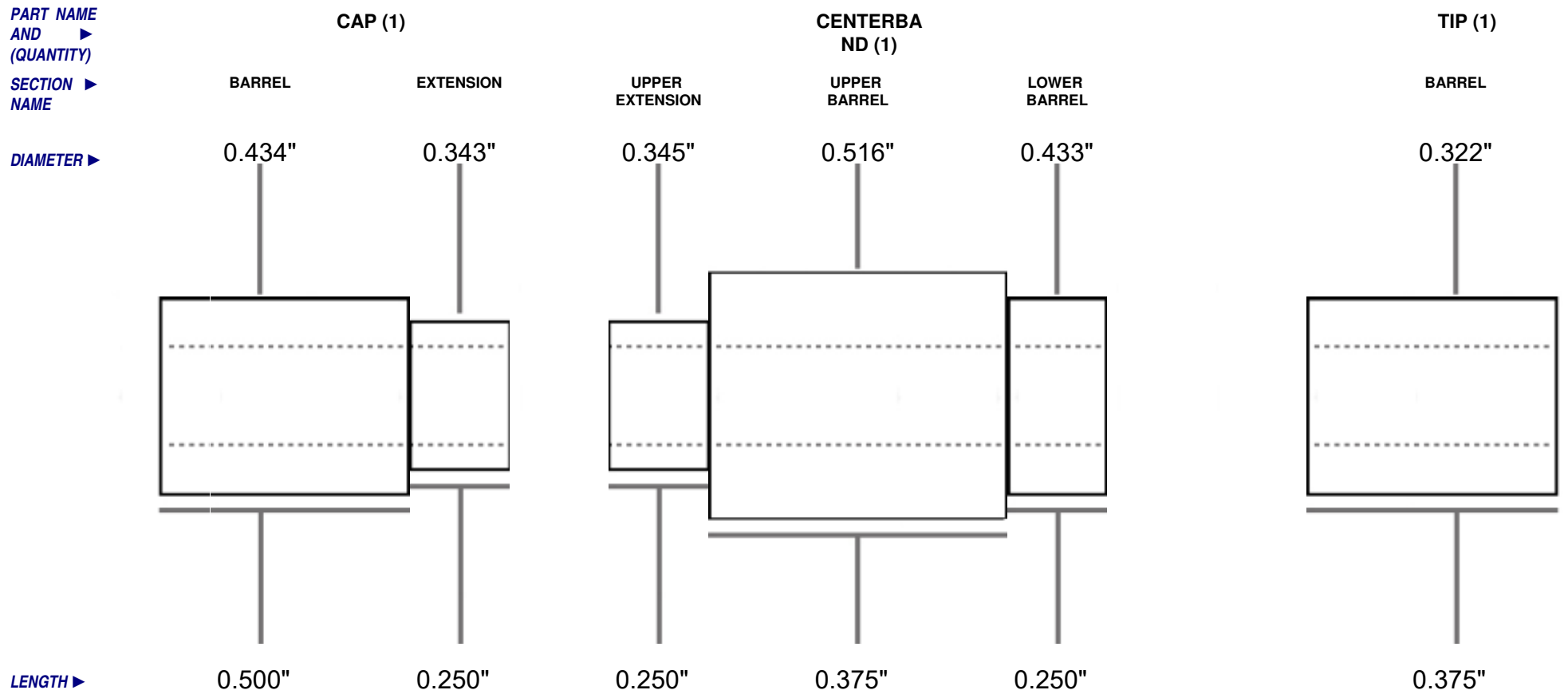

ASSOCIATED PKGRAD(XX)
KITS:

PICTURE IS AN APPROXIMATE REPRESENTATION. NOT TO EXACT SCALE OR PROPORTION. ALL MEASUREMENTS IN INCHES. BUSHING DIAMETERS (TOP ROW) ARE OPTIMAL AND SHOULD VARY BY NO MORE THAN .002" WHEN NEW.

ID NUMBER PKGRAPBU **TYPE:** BUSHING

NOTES:

NUMBER OF PARTS 3

THRU HOLE STANDARD (0.248')

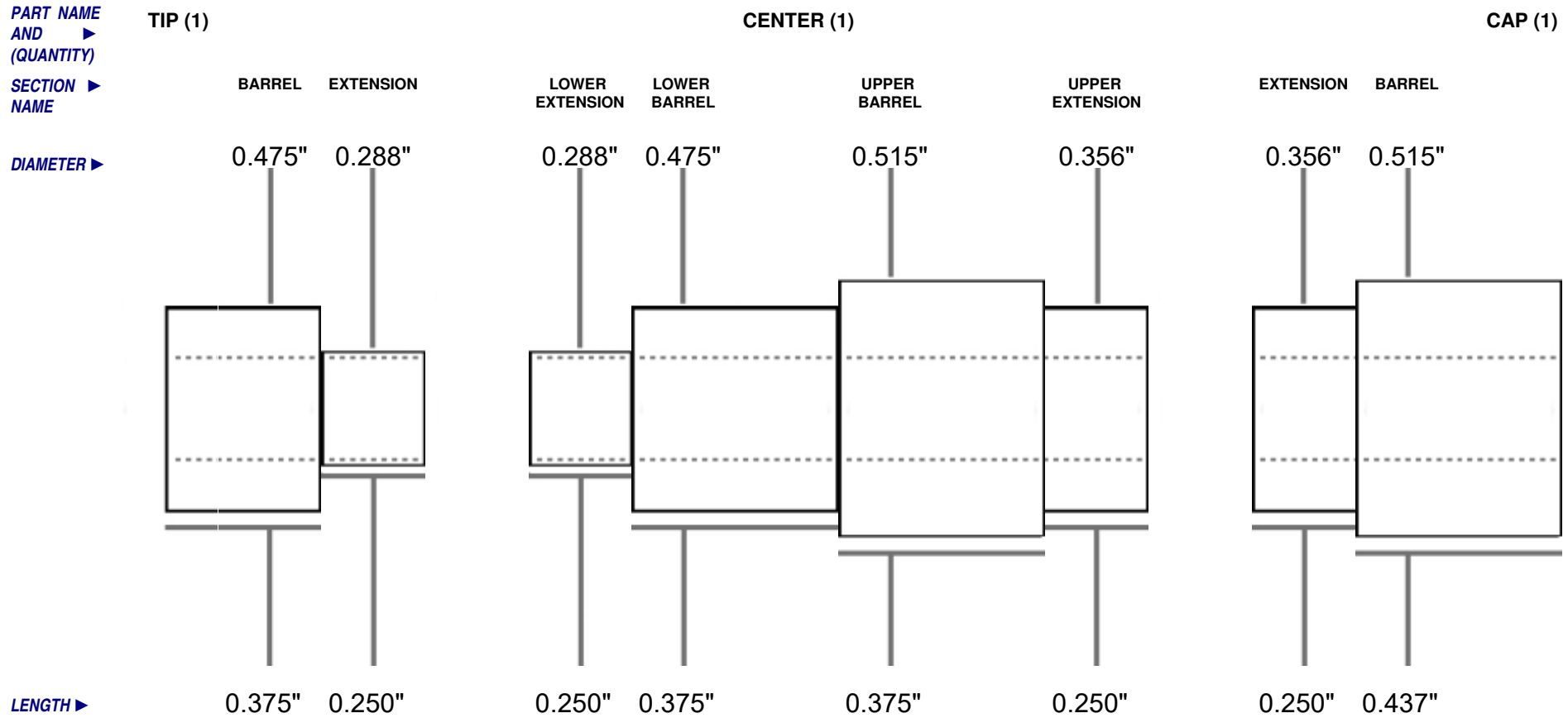

ASSOCIATED PKGRAP(XX)

KITS:

PICTURE IS AN APPROXIMATE REPRESENTATION. NOT TO EXACT SCALE OR PROPORTION. ALL MEASUREMENTS IN INCHES. BUSHING DIAMETERS (TOP ROW) ARE OPTIMAL AND SHOULD VARY BY NO MORE THAN .002" WHEN NEW.

ID NUMBER PKGREATBU **TYPE:** BUSHING

NOTES:

NUMBER OF PARTS 3

THRU HOLE STANDARD (0.248')

PART NAME AND (QUANTITY)

SECTION NAME

DIAMETER

LENGTH

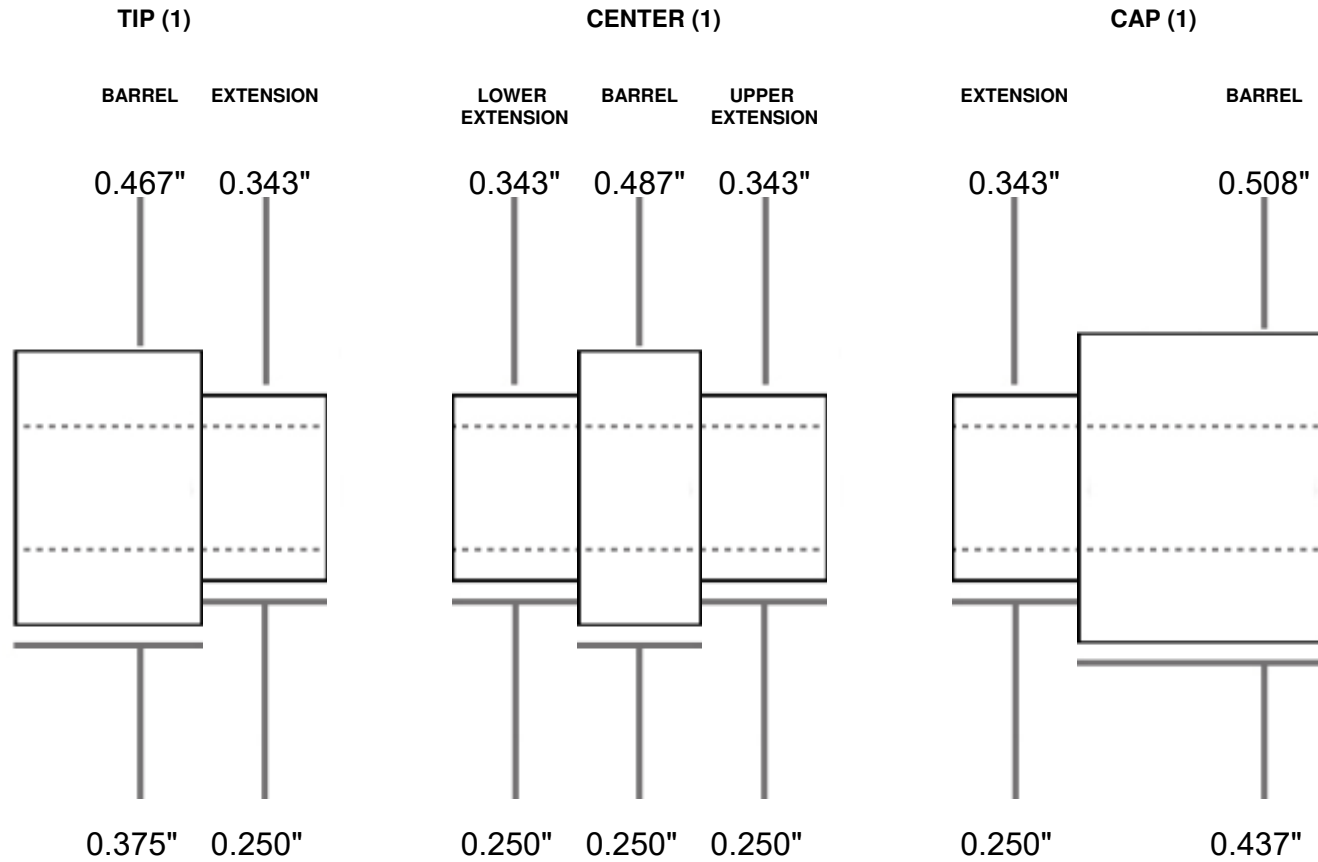

ASSOCIATED KITS:

PICTURE IS AN APPROXIMATE REPRESENTATION. NOT TO EXACT SCALE OR PROPORTION. ALL MEASUREMENTS IN INCHES. BUSHING DIAMETERS (TOP ROW) ARE OPTIMAL AND SHOULD VARY BY NO MORE THAN .002" WHEN NEW.

ID NUMBER PKGRENBU **TYPE:** BUSHING

NOTES:

NUMBER OF PARTS 2

THRU HOLE STANDARD (0.248')

PART NAME AND (QUANTITY)

SECTION NAME

DIAMETER

LENGTH

CAP (1)

TIP (1)

BARREL

EXTENSION

EXTENSION

BARREL

0.650"

0.360"

0.360"

0.570"

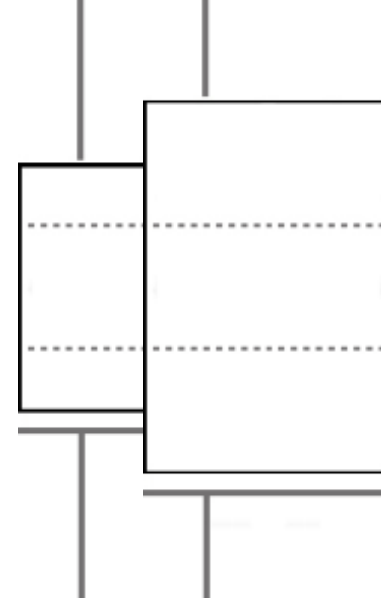
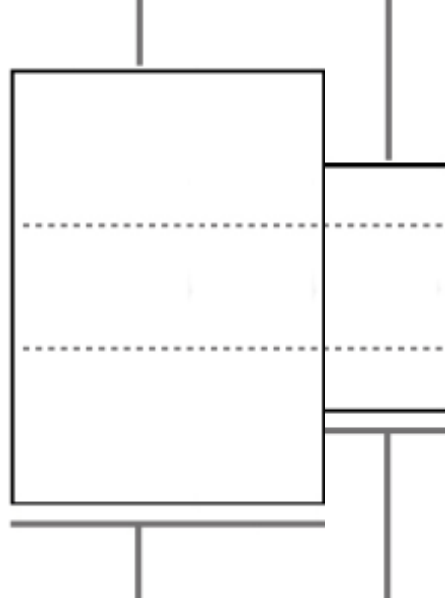

0.500"

0.250"

0.250"

0.378"

ASSOCIATED PKGREN(XX)

KITS:

PICTURE IS AN APPROXIMATE REPRESENTATION. NOT TO EXACT SCALE OR PROPORTION. ALL MEASUREMENTS IN INCHES. BUSHING DIAMETERS (TOP ROW) ARE OPTIMAL AND SHOULD VARY BY NO MORE THAN .002" WHEN NEW.

ID NUMBER PKGRIND7BU **TYPE:** BUSHING

NUMBER OF PARTS 2

THRU HOLE STANDARD (0.248')

NOTES: TOP AND BOTTOM SAME DIMENSION. FLANGE DIMENSION DOES NOT NEED TO BE EXACT AS IT ONLY FUNCTIONS TO HOLD THE PIECE BETWEEN CENTERS.

PART NAME AND (QUANTITY)

SECTION NAME

DIAMETER

LENGTH

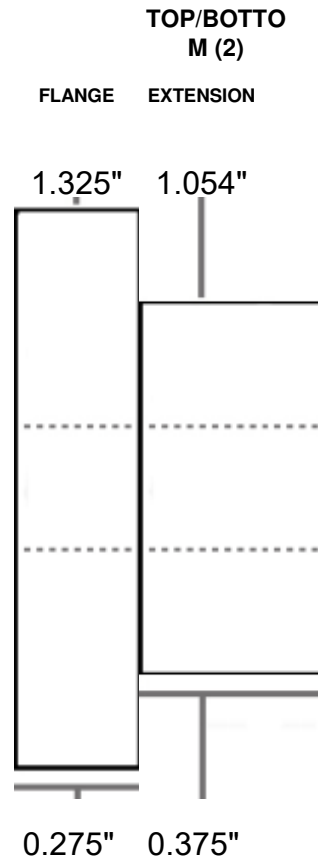

ASSOCIATED KITS: PKGRIND7(BC)(XX), PKGRIND71(XX), PKGRIUL(XX)

PICTURE IS AN APPROXIMATE REPRESENTATION. NOT TO EXACT SCALE OR PROPORTION. ALL MEASUREMENTS IN INCHES. BUSHING DIAMETERS (TOP ROW) ARE OPTIMAL AND SHOULD VARY BY NO MORE THAN .002" WHEN NEW.

ID NUMBER PKGRIND8BU **TYPE:** BUSHING

NOTES: THERE ARE TWO BUSHINGS OF EACH SIZE

NUMBER OF PARTS 4

THRU HOLE STANDARD(0.248")

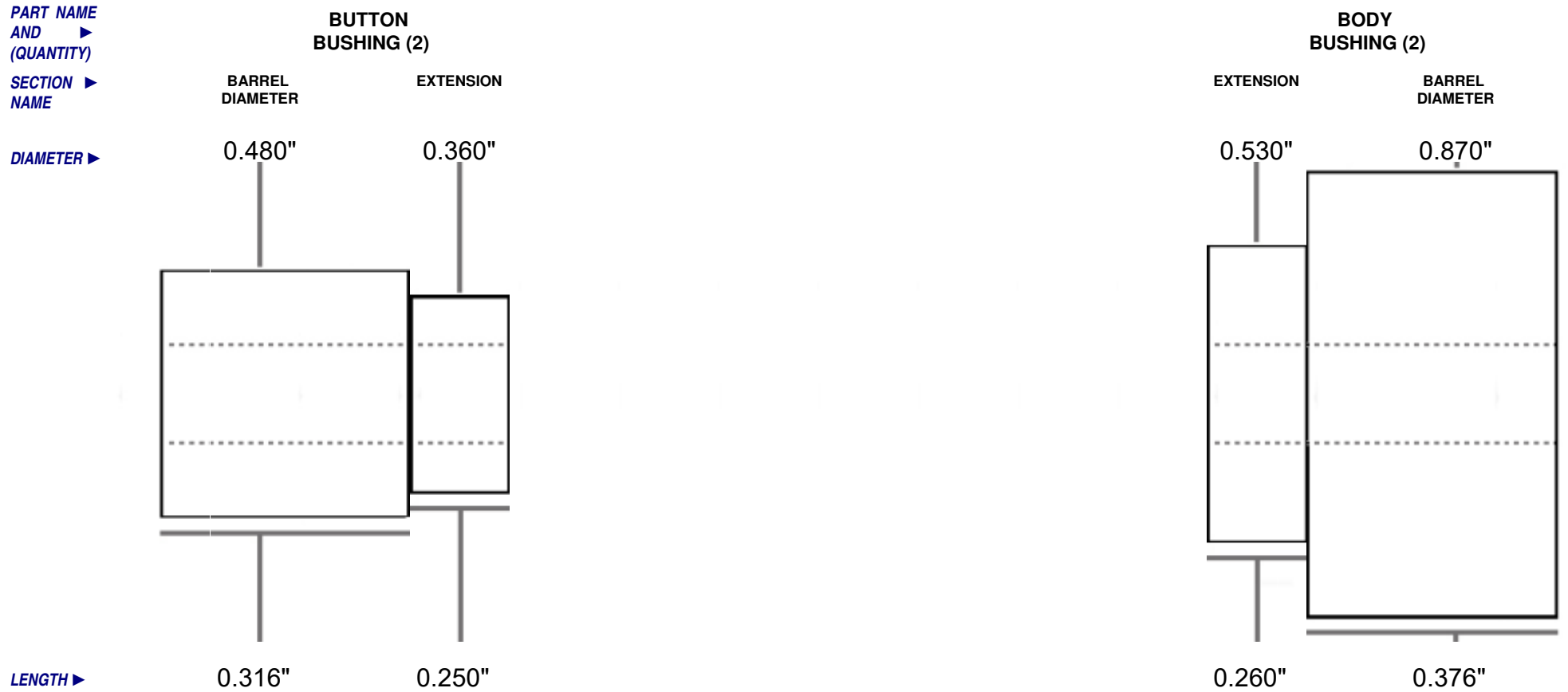

ASSOCIATED PKGRIND8(XX)
KITS:

PICTURE IS AN APPROXIMATE REPRESENTATION. NOT TO EXACT SCALE OR PROPORTION. ALL MEASUREMENTS IN INCHES. BUSHING DIAMETERS (TOP ROW) ARE OPTIMAL AND SHOULD VARY BY NO MORE THAN .002" WHEN NEW.

ID NUMBER PKHGBU

TYPE: BUSHING

NOTES:

NUMBER OF PARTS 2

THRU HOLE STANDARD (0.248')

PART NAME AND (QUANTITY)

SECTION NAME

DIAMETER

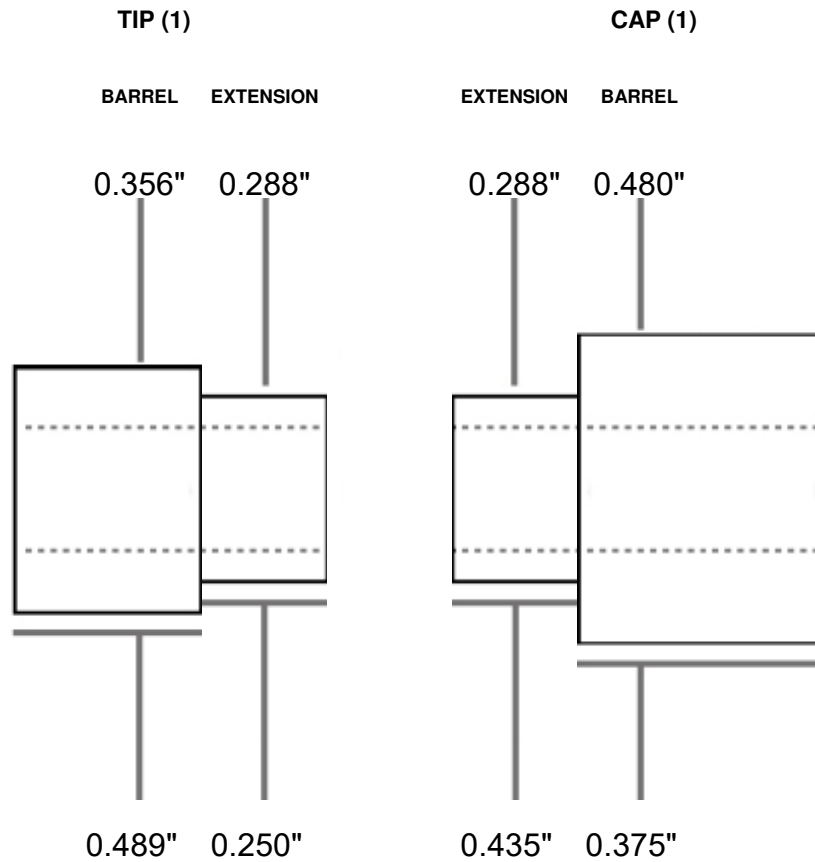

LENGTH

ASSOCIATED PKHG(XX)

KITS:

PICTURE IS AN APPROXIMATE REPRESENTATION. NOT TO EXACT SCALE OR PROPORTION. ALL MEASUREMENTS IN INCHES. BUSHING DIAMETERS (TOP ROW) ARE OPTIMAL AND SHOULD VARY BY NO MORE THAN .002" WHEN NEW.

ID NUMBER PKHPENBU

TYPE: BUSHING

NOTES:

NUMBER OF PARTS 3

THRU HOLE STANDARD(0.248")

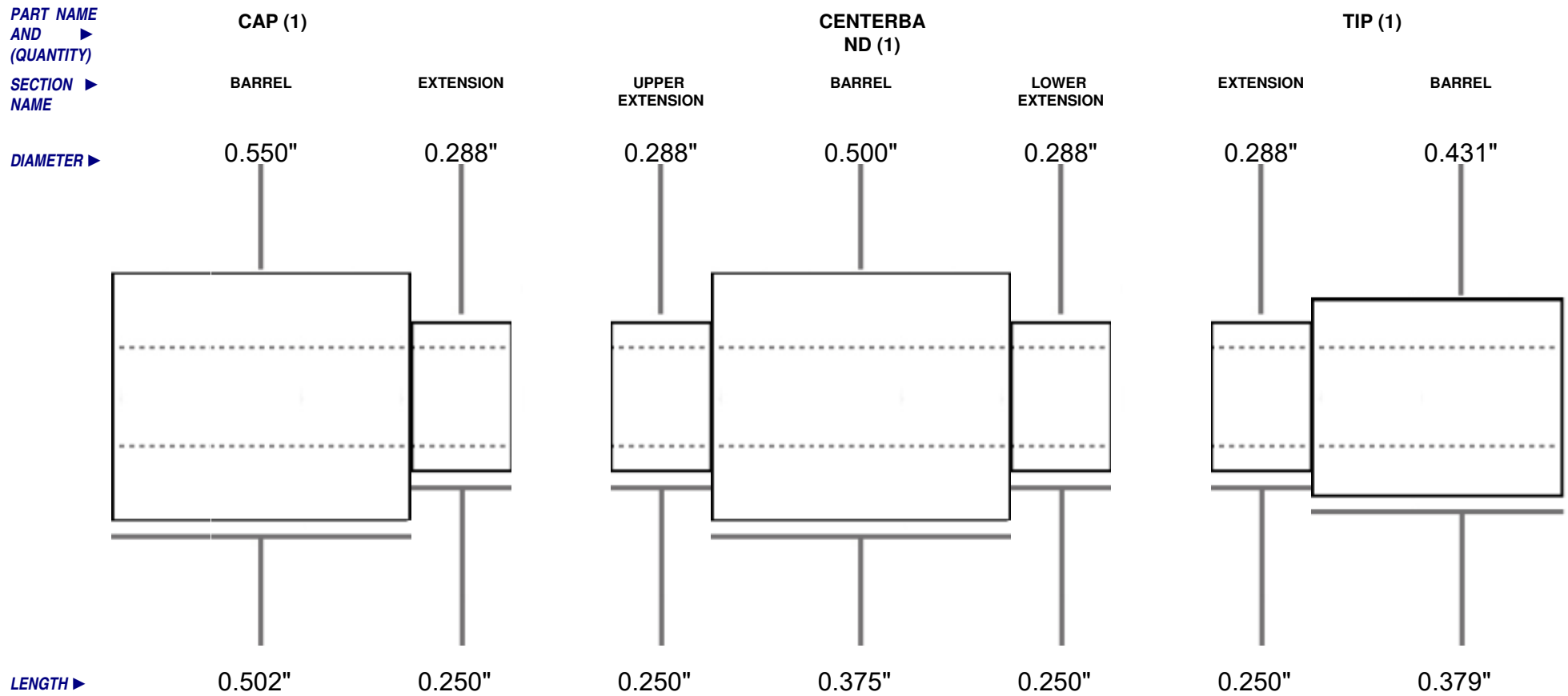

ASSOCIATED PKHPEN(XX)

KITS:

PICTURE IS AN APPROXIMATE REPRESENTATION. NOT TO EXACT SCALE OR PROPORTION. ALL MEASUREMENTS IN INCHES. BUSHING DIAMETERS (TOP ROW) ARE OPTIMAL AND SHOULD VARY BY NO MORE THAN .002" WHEN NEW.

ID NUMBER PKHPRBU

TYPE: BUSHING

NOTES:

NUMBER OF PARTS 3

THRU HOLE STANDARD (0.248')

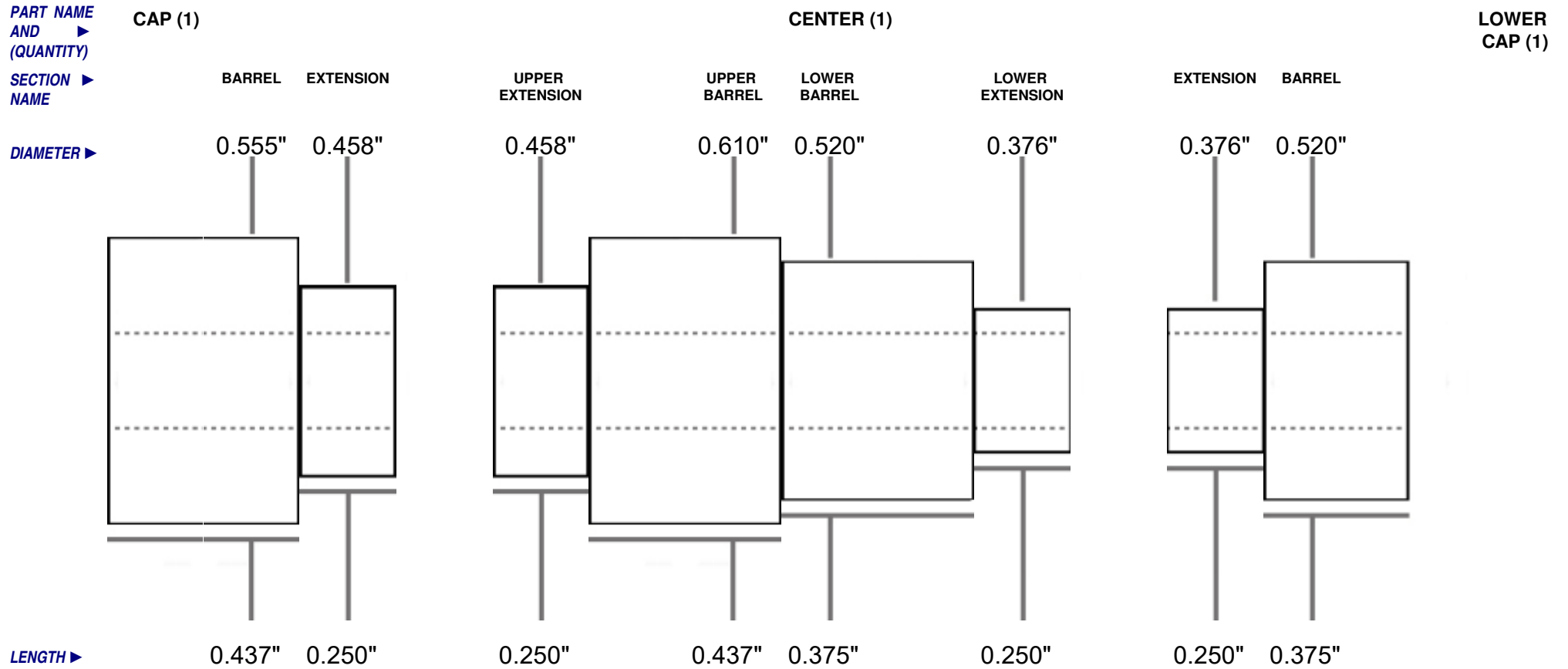

ASSOCIATED PKHPEF(XX), PKHPER(XX)

KITS:

PICTURE IS AN APPROXIMATE REPRESENTATION. NOT TO EXACT SCALE OR PROPORTION. ALL MEASUREMENTS IN INCHES. BUSHING DIAMETERS (TOP ROW) ARE OPTIMAL AND SHOULD VARY BY NO MORE THAN .002" WHEN NEW.

ID NUMBER PKISCOOPBU **TYPE:** BUSHING

NOTES: BOTH BUSHINGS HAVE SAME DIMENSIONS

NUMBER OF PARTS 2

THRU HOLE STANDARD(0.248")

PART NAME AND (QUANTITY)

SECTION NAME

DIAMETER

LENGTH

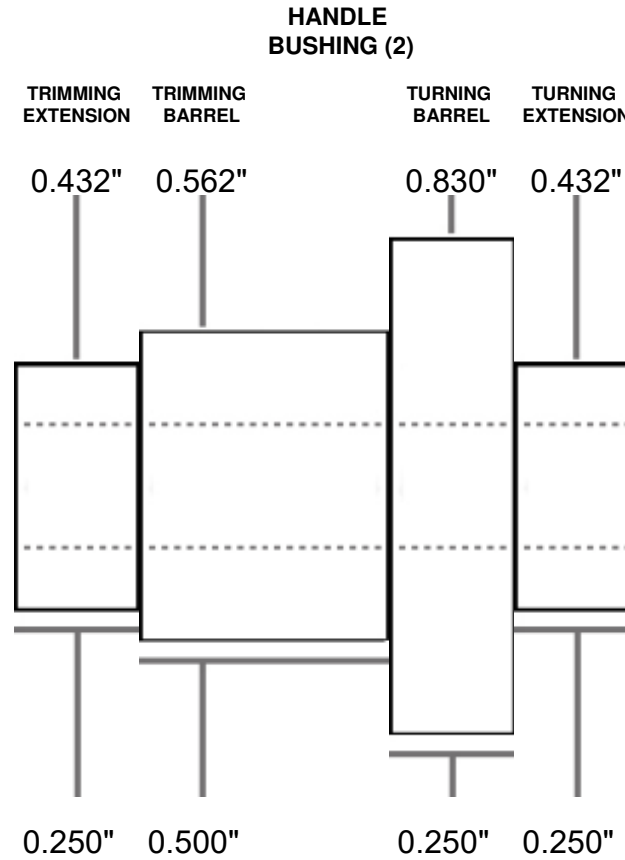

ASSOCIATED PKISCOOP(XX)

KITS:

PICTURE IS AN APPROXIMATE REPRESENTATION. NOT TO EXACT SCALE OR PROPORTION. ALL MEASUREMENTS IN INCHES. BUSHING DIAMETERS (TOP ROW) ARE OPTIMAL AND SHOULD VARY BY NO MORE THAN .002" WHEN NEW.

ID NUMBER PKJPENBU

TYPE: BUSHING

NOTES:

NUMBER OF PARTS 2

THRU HOLE STANDARD(0.248")

PART NAME AND (QUANTITY)

SECTION NAME

DIAMETER

LENGTH

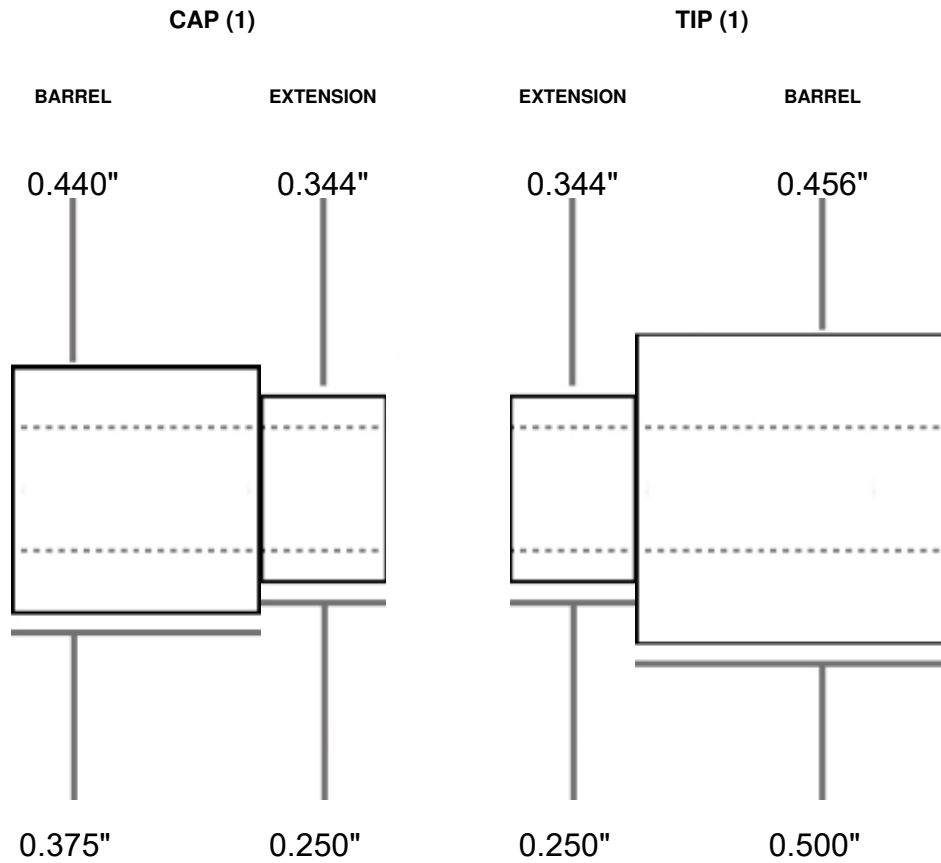

ASSOCIATED PKJPEN(XX), PKL70(XX)

KITS:

PICTURE IS AN APPROXIMATE REPRESENTATION. NOT TO EXACT SCALE OR PROPORTION. ALL MEASUREMENTS IN INCHES. BUSHING DIAMETERS (TOP ROW) ARE OPTIMAL AND SHOULD VARY BY NO MORE THAN .002" WHEN NEW.

ID NUMBER PKKNBU

TYPE: BUSHING

NOTES: BOTH SIDES HAVE SAME DIMENSION

NUMBER OF PARTS 2

THRU HOLE STANDARD(0.248")

PART NAME AND (QUANTITY)

SECTION NAME

DIAMETER

LENGTH

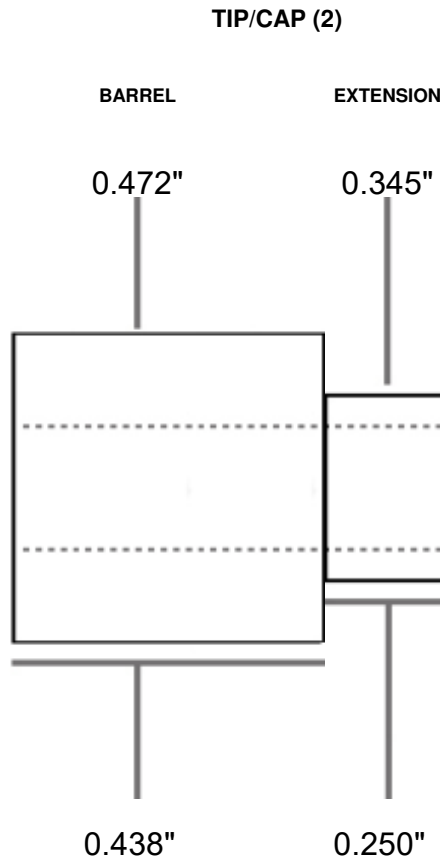

ASSOCIATED PKKN(XX), PKKNST(XX), PKTUD(XX)

KITS:

PICTURE IS AN APPROXIMATE REPRESENTATION. NOT TO EXACT SCALE OR PROPORTION. ALL MEASUREMENTS IN INCHES. BUSHING DIAMETERS (TOP ROW) ARE OPTIMAL AND SHOULD VARY BY NO MORE THAN .002" WHEN NEW.

ID NUMBER PKL750BU

TYPE: BUSHING

NOTES: CAP AND TIP BUSHINGS ARE THE SAME DIMENSION

NUMBER OF PARTS 2

THRU HOLE STANDARD(0.248")

PART NAME AND (QUANTITY)

SECTION NAME

DIAMETER

LENGTH

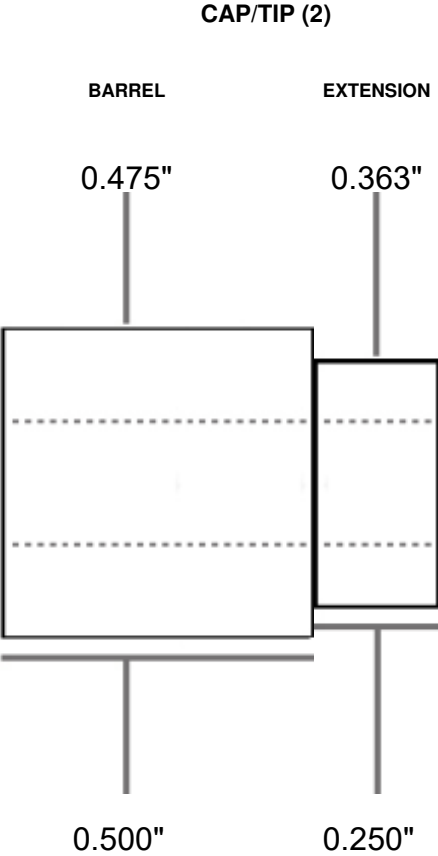

ASSOCIATED PKL75(XX)
KITS:

PICTURE IS AN APPROXIMATE REPRESENTATION. NOT TO EXACT SCALE OR PROPORTION. ALL MEASUREMENTS IN INCHES. BUSHING DIAMETERS (TOP ROW) ARE OPTIMAL AND SHOULD VARY BY NO MORE THAN .002" WHEN NEW.

ID NUMBER PKL760BU

TYPE: BUSHING

NOTES: BOTH BUSHINGS SAME DIMENSION

NUMBER OF PARTS 2

THRU HOLE STANDARD (0.248')

PART NAME AND (QUANTITY)

SECTION NAME

DIAMETER

LENGTH

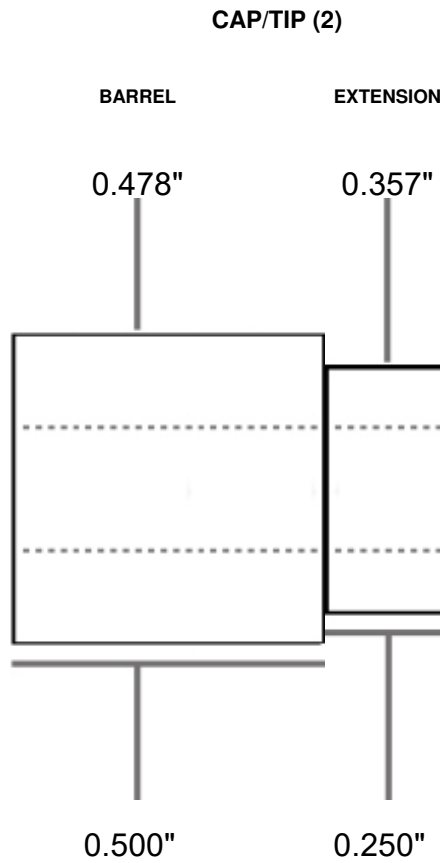

ASSOCIATED PKL76(XX)

KITS:

PICTURE IS AN APPROXIMATE REPRESENTATION. NOT TO EXACT SCALE OR PROPORTION. ALL MEASUREMENTS IN INCHES. BUSHING DIAMETERS (TOP ROW) ARE OPTIMAL AND SHOULD VARY BY NO MORE THAN .002" WHEN NEW.

ID NUMBER PKLBALMBU **TYPE:** BUSHING

NOTES:

NUMBER OF PARTS 2

THRU HOLE STANDARD (0.248')

PART NAME AND (QUANTITY)

SECTION NAME

DIAMETER

LENGTH

ASSOCIATED KITS:

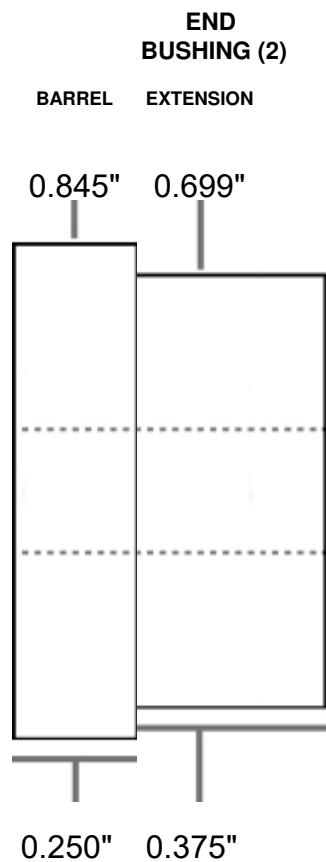

PICTURE IS AN APPROXIMATE REPRESENTATION. NOT TO EXACT SCALE OR PROPORTION. ALL MEASUREMENTS IN INCHES. BUSHING DIAMETERS (TOP ROW) ARE OPTIMAL AND SHOULD VARY BY NO MORE THAN .002" WHEN NEW.

ID NUMBER PKLEVBU

TYPE: BUSHING

NOTES:

NUMBER OF PARTS 2

THRU HOLE STANDARD (0.248')

PART NAME AND (QUANTITY)

SECTION NAME

DIAMETER

CENTER (1)

TIP (1)

BARREL

EXTENSION

EXTENSION

BARREL

0.500"

0.360"

0.360"

0.484"

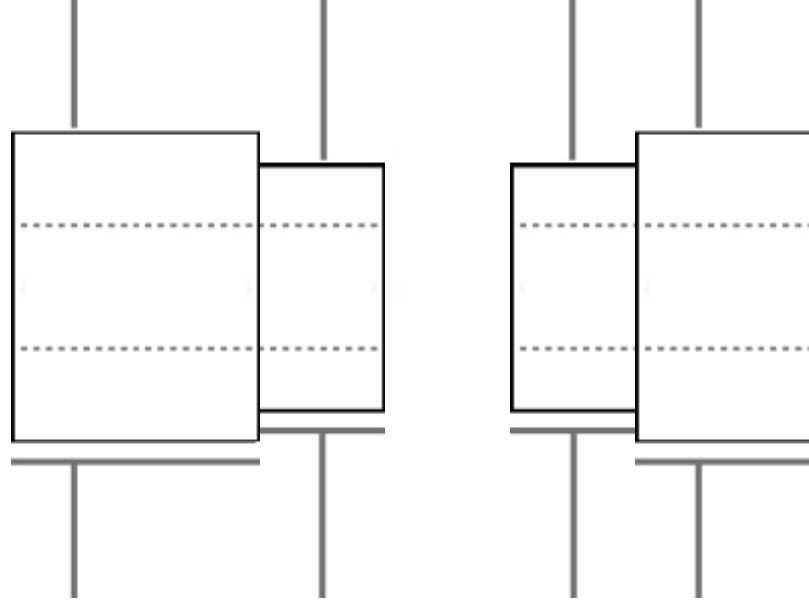

LENGTH

0.437"

0.250"

0.250"

0.375"

ASSOCIATED PKLEV(XX), PKLEV(XX)X

KITS:

PICTURE IS AN APPROXIMATE REPRESENTATION. NOT TO EXACT SCALE OR PROPORTION. ALL MEASUREMENTS IN INCHES. BUSHING DIAMETERS (TOP ROW) ARE OPTIMAL AND SHOULD VARY BY NO MORE THAN .002" WHEN NEW.

ID NUMBER PKLONGBU **TYPE:** BUSHING

NOTES: USE TUIP BUSHING ONLY IF RUBBER GRIP IS NOT USED. CENTER BUSHING HAS EXTENSION BECAUSE FRONT HALF OF UPPER BARREL HAS NO TUBE.

NUMBER OF PARTS 3

THRU HOLE STANDARD(0.248")

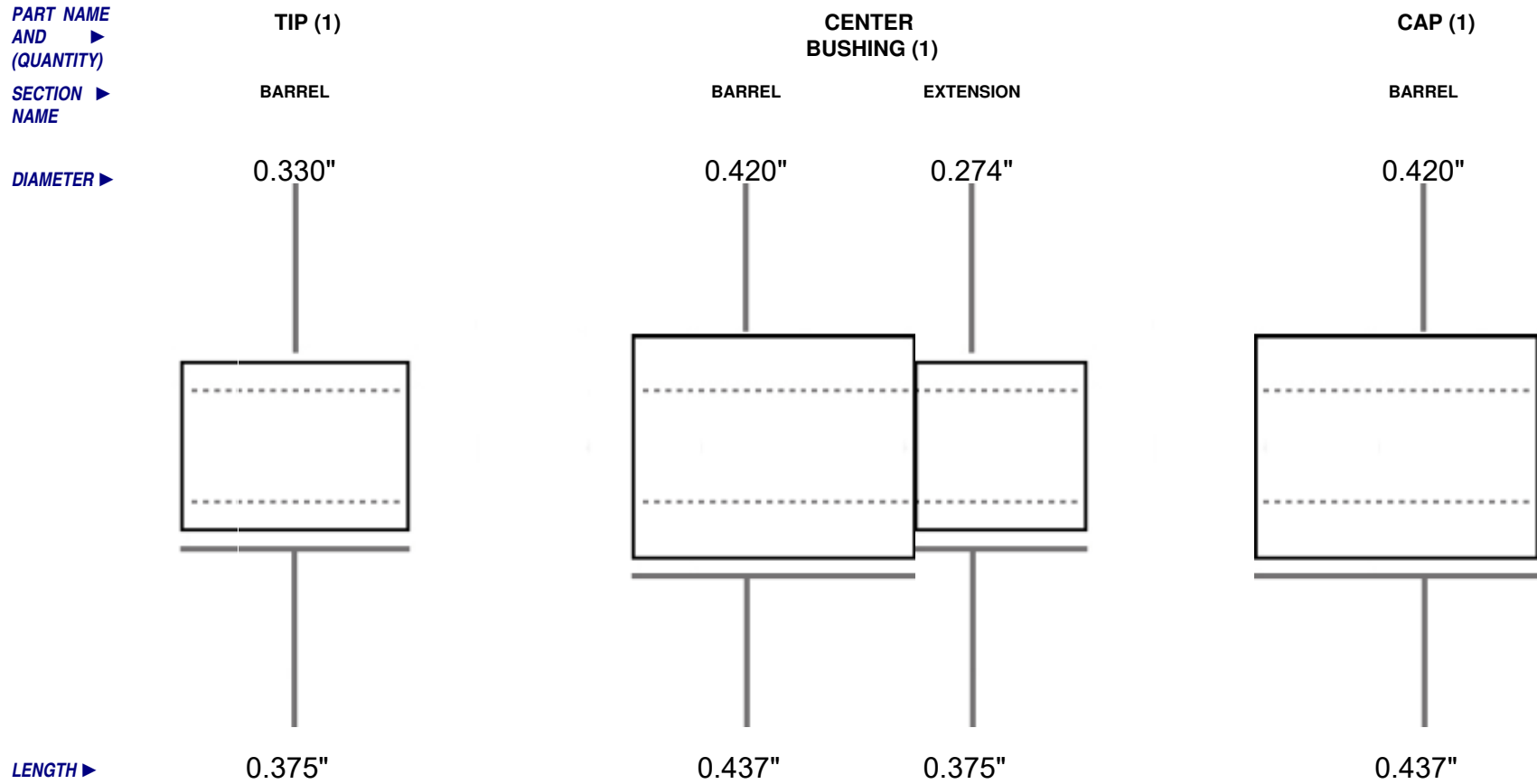

ASSOCIATED PKLONGPCL(XX), PKLONGPEN(XX)
KITS:

PICTURE IS AN APPROXIMATE REPRESENTATION. NOT TO EXACT SCALE OR PROPORTION. ALL MEASUREMENTS IN INCHES. BUSHING DIAMETERS (TOP ROW) ARE OPTIMAL AND SHOULD VARY BY NO MORE THAN .002" WHEN NEW.

ID NUMBER PKLPULLFBU **TYPE:** BUSHING

NOTES: BOTH SIDES SAME DIAMETERS

NUMBER OF PARTS 2

THRU HOLE STANDARD (0.248')

**PART NAME
AND ►
(QUANTITY)**

**SECTION ►
NAME**

DIAMETER ►

**END
BUSHING (2)**

BARREL

0.485"



LENGTH ►

0.437"

ASSOCIATED PKLPULLF(XX)

KITS:

PICTURE IS AN APPROXIMATE REPRESENTATION. NOT TO EXACT SCALE OR PROPORTION. ALL MEASUREMENTS IN INCHES. BUSHING DIAMETERS (TOP ROW) ARE OPTIMAL AND SHOULD VARY BY NO MORE THAN .002" WHEN NEW.

ID NUMBER PKLSBU TYPE: BUSHING

NOTES: SLEEVE FITS ON 7MM TRIMMER SHAFT. END BUSHINGS HAVE SAME DIMENSIONS

NUMBER OF PARTS 4

THRU HOLE STANDARD (0.248")

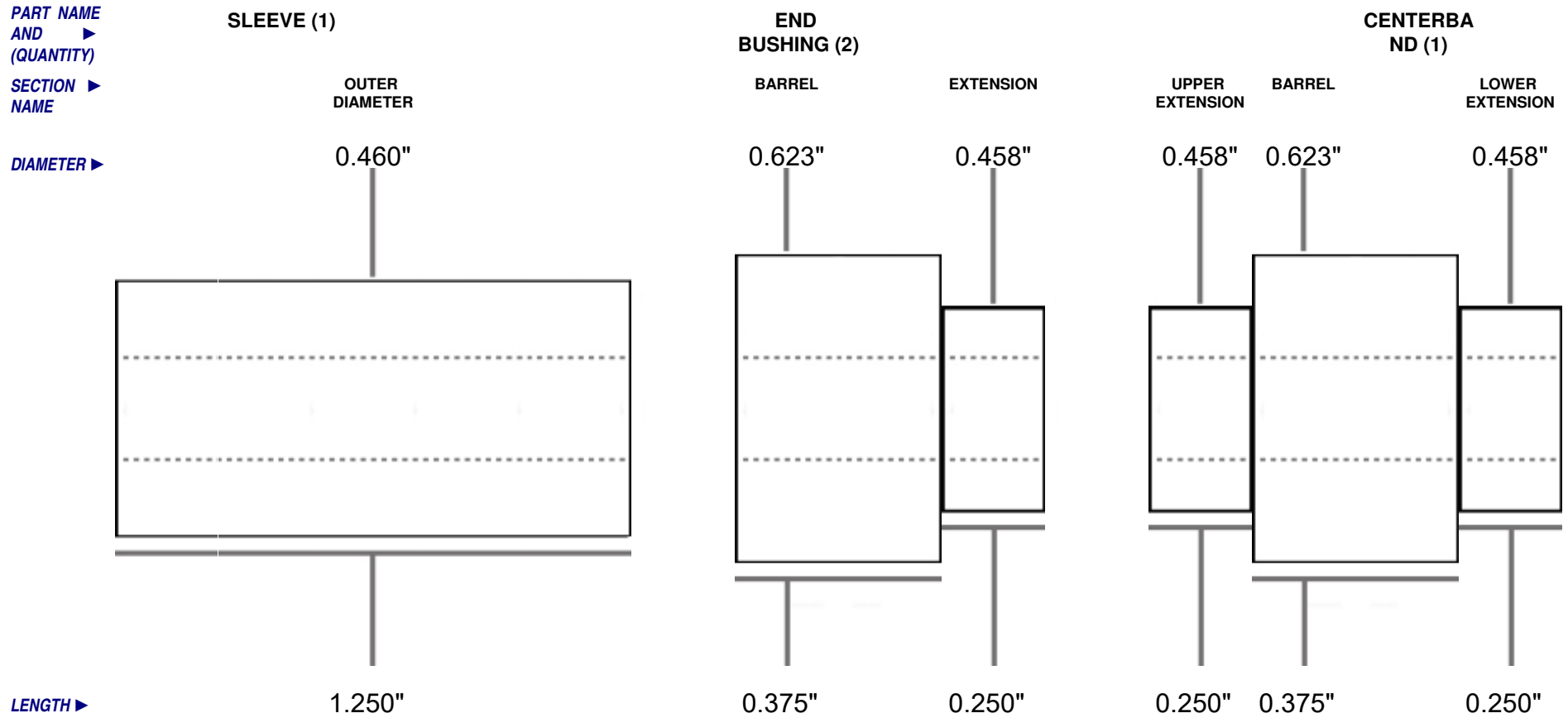

ASSOCIATED PKLSPEN(XX) KITS:

PICTURE IS AN APPROXIMATE REPRESENTATION. NOT TO EXACT SCALE OR PROPORTION. ALL MEASUREMENTS IN INCHES. BUSHING DIAMETERS (TOP ROW) ARE OPTIMAL AND SHOULD VARY BY NO MORE THAN .002" WHEN NEW.

ID NUMBER PKMAGNECBU **TYPE:** BUSHING

NOTES: PEN CENTER BUSHING IS LARGER THAN THE PEN TIP BASE.

NUMBER OF PARTS 3

THRU HOLE STANDARD (0.248')

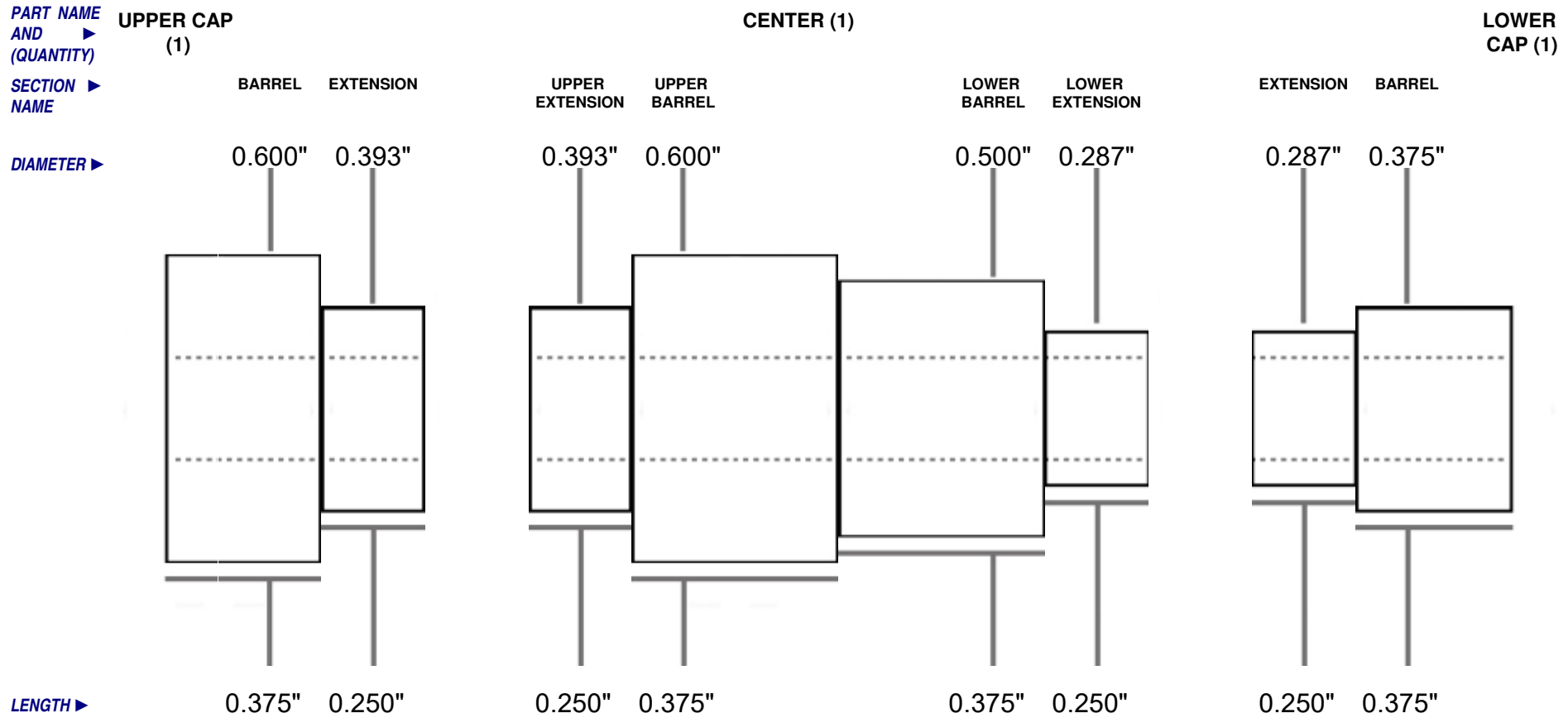

ASSOCIATED PKFNEC(XX), PKMAGNEC(XX)
KITS:

PICTURE IS AN APPROXIMATE REPRESENTATION. NOT TO EXACT SCALE OR PROPORTION. ALL MEASUREMENTS IN INCHES. BUSHING DIAMETERS (TOP ROW) ARE OPTIMAL AND SHOULD VARY BY NO MORE THAN .002" WHEN NEW.

ID NUMBER PKMAJBTS **TYPE:** TRIMMING SLEEVE
NUMBER OF PARTS 2

NOTES: FITS STANDARD TUBES SIZED 37/64" (UPPER) AND 15/32" (LOWER)

THRU HOLE ACCEPTS 7MM TRIMMING SHAFT

PART NAME AND (QUANTITY) UPPER (1)

SECTION NAME SLEEVE

DIAMETER 0.546"

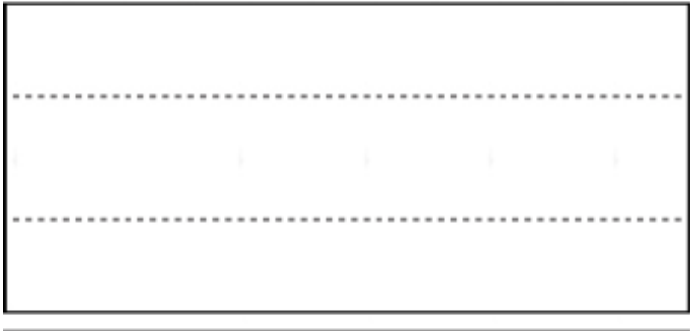

LENGTH 1.877"

LOWER (1)

SLEEVE

0.427"



2.000"

ASSOCIATED KITS:

PICTURE IS AN APPROXIMATE REPRESENTATION. NOT TO EXACT SCALE OR PROPORTION. ALL MEASUREMENTS IN INCHES. BUSHING DIAMETERS (TOP ROW) ARE OPTIMAL AND SHOULD VARY BY NO MORE THAN .002" WHEN NEW.

ID NUMBER PKMAJBU

TYPE: BUSHING

NOTES:

NUMBER OF PARTS 3

THRU HOLE STANDARD(0.248")

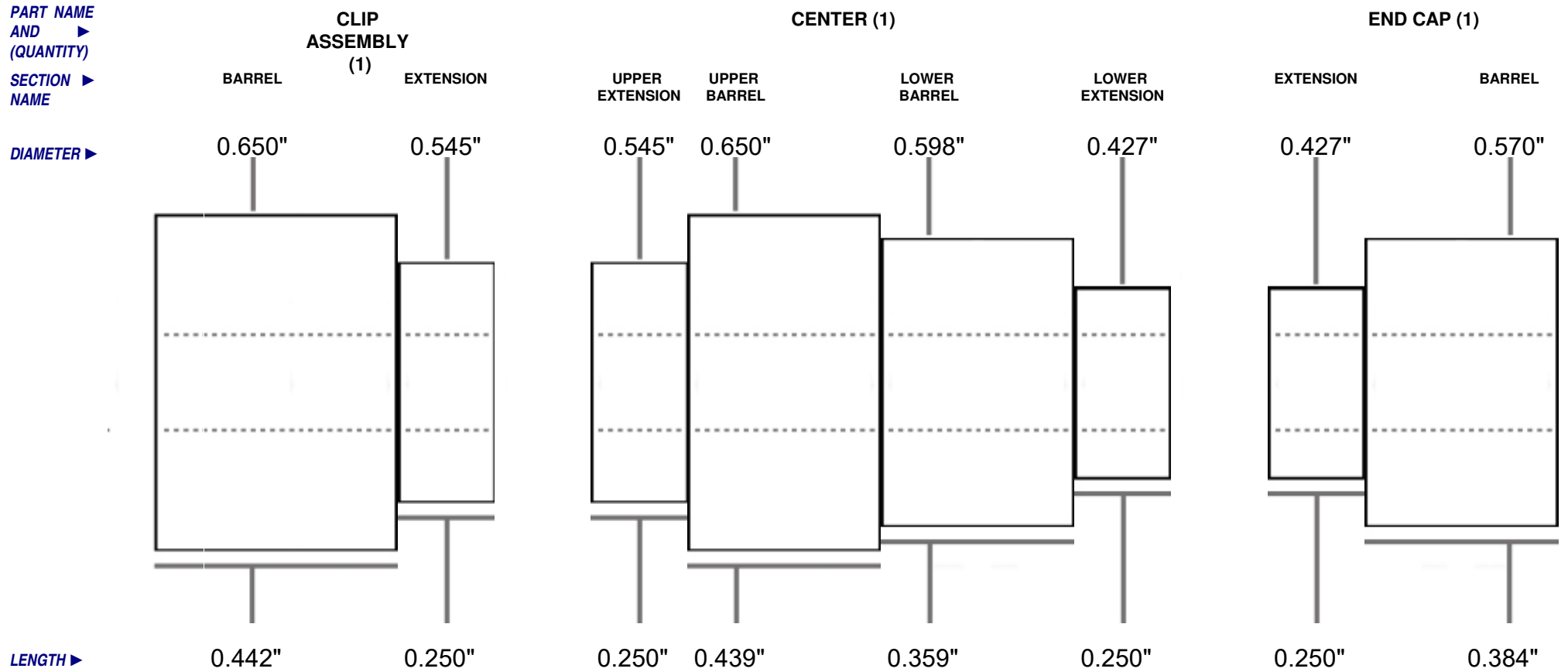

ASSOCIATED PKMAF(XX), PKMAJ(XX)

KITS:

PICTURE IS AN APPROXIMATE REPRESENTATION. NOT TO EXACT SCALE OR PROPORTION. ALL MEASUREMENTS IN INCHES. BUSHING DIAMETERS (TOP ROW) ARE OPTIMAL AND SHOULD VARY BY NO MORE THAN .002" WHEN NEW.

ID NUMBER PKMAJJRBT5 **TYPE:** TRIMMING SLEEVE

NOTES: FITS STANDARD TUBES SIZED 12.5MM (UPPER) AND 10.5MM (LOWER)

NUMBER OF PARTS 2

THRU HOLE ACCEPTS 7MM TRIMMER SHAFT

PART NAME AND (QUANTITY)

UPPER (1)

LOWER (1)

SECTION NAME

BARREL

BARREL

DIAMETER

0.460"

0.376"

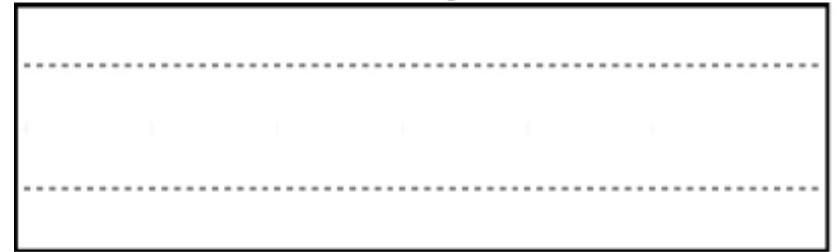
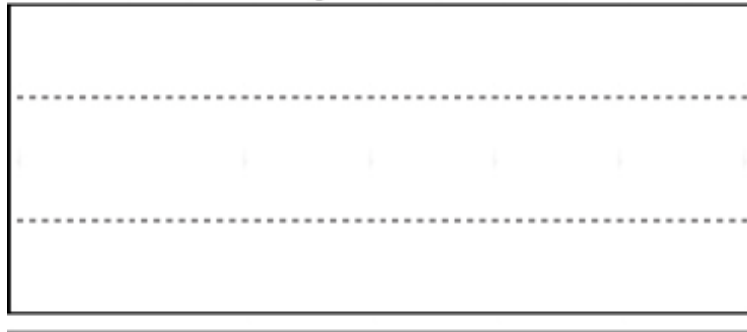

LENGTH

1.876"

2.000"

ASSOCIATED KITS:

PICTURE IS AN APPROXIMATE REPRESENTATION. NOT TO EXACT SCALE OR PROPORTION. ALL MEASUREMENTS IN INCHES. BUSHING DIAMETERS (TOP ROW) ARE OPTIMAL AND SHOULD VARY BY NO MORE THAN .002" WHEN NEW.

ID NUMBER PKMAJJRBU **TYPE:** BUSHING

NOTES:

NUMBER OF PARTS 3

THRU HOLE STANDARD(0.248")

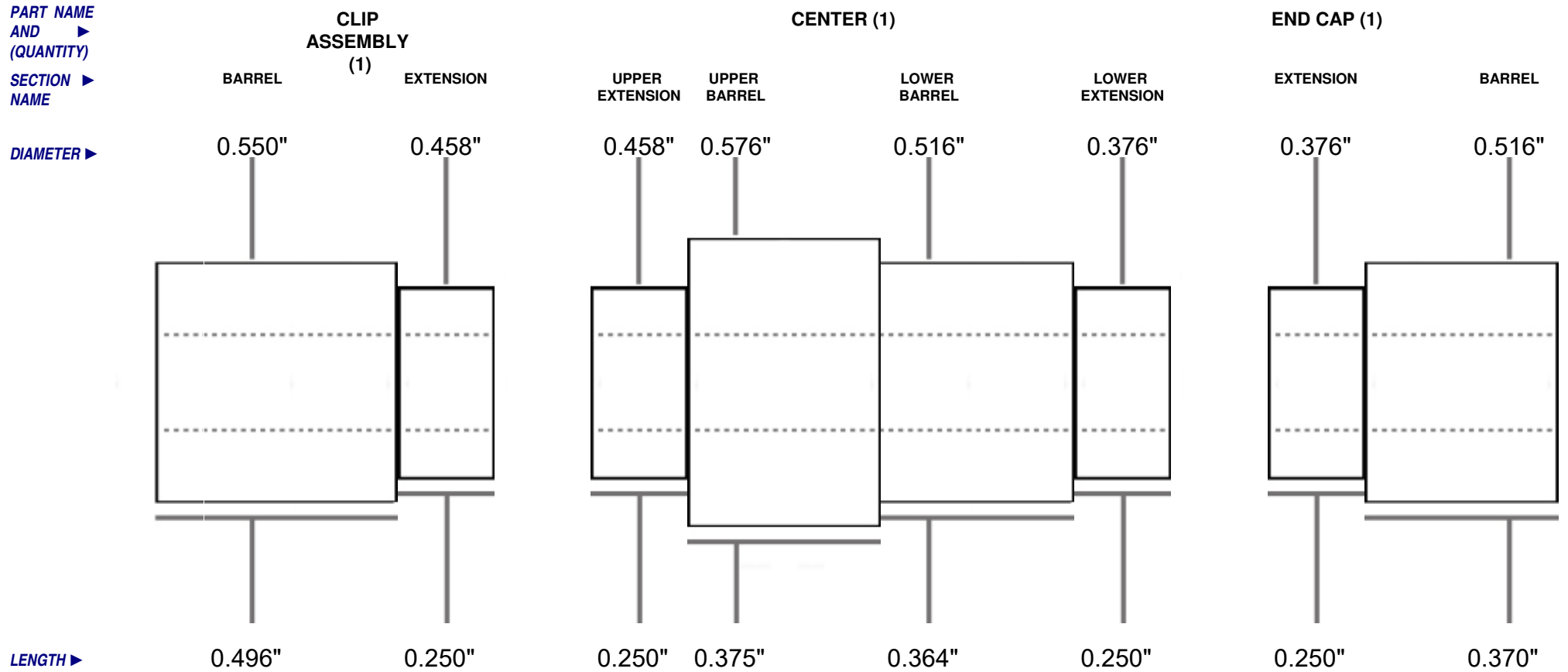

ASSOCIATED KITS: PKMAF(XX)JR, PKMAJ(XX)JR, PKSWXR(XX)

PICTURE IS AN APPROXIMATE REPRESENTATION. NOT TO EXACT SCALE OR PROPORTION. ALL MEASUREMENTS IN INCHES. BUSHING DIAMETERS (TOP ROW) ARE OPTIMAL AND SHOULD VARY BY NO MORE THAN .002" WHEN NEW.

ID NUMBER PKMAJLOBU **TYPE:** BUSHING

NOTES: BOTH SIDES SAME DIMENSION

NUMBER OF PARTS 2

THRU HOLE STANDARD (0.248')

PART NAME AND (QUANTITY)

SECTION NAME

DIAMETER

LENGTH

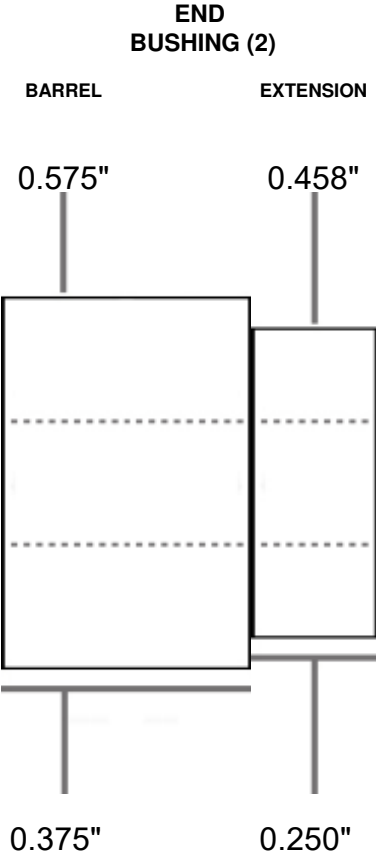

ASSOCIATED PKMAJLO(XX)
KITS:

PICTURE IS AN APPROXIMATE REPRESENTATION. NOT TO EXACT SCALE OR PROPORTION. ALL MEASUREMENTS IN INCHES. BUSHING DIAMETERS (TOP ROW) ARE OPTIMAL AND SHOULD VARY BY NO MORE THAN .002" WHEN NEW.

ID NUMBER PKMAJSQBU **TYPE:** BUSHING

NOTES: BOTH SIDES ARE THE SAME DIMENSION

NUMBER OF PARTS 2

THRU HOLE STANDARD(0.248")

PART NAME AND (QUANTITY)

SECTION NAME

DIAMETER

LENGTH

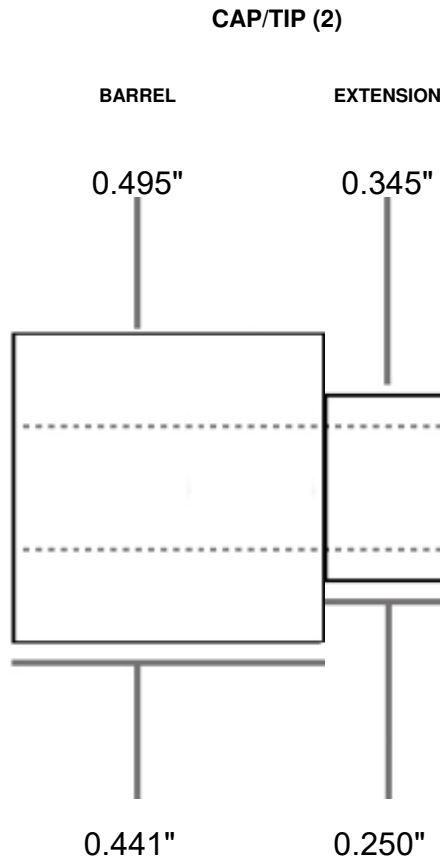

ASSOCIATED KITS: PKA1(XX), PKART(XX)B, PKDBN(XX), PKDOG(XX), PKGEAR(XX), PKMAJSQ(XX), PKNAUT(XX), PKRAHANMJ(XX), PKRAW(XX), PKRAWF(XX), PKRPEN(XX)

PICTURE IS AN APPROXIMATE REPRESENTATION. NOT TO EXACT SCALE OR PROPORTION. ALL MEASUREMENTS IN INCHES. BUSHING DIAMETERS (TOP ROW) ARE OPTIMAL AND SHOULD VARY BY NO MORE THAN .002" WHEN NEW.

ID NUMBER PKMAYBU

TYPE: BUSHING

NOTES:

NUMBER OF PARTS 3

THRU HOLE STANDARD(0.248")

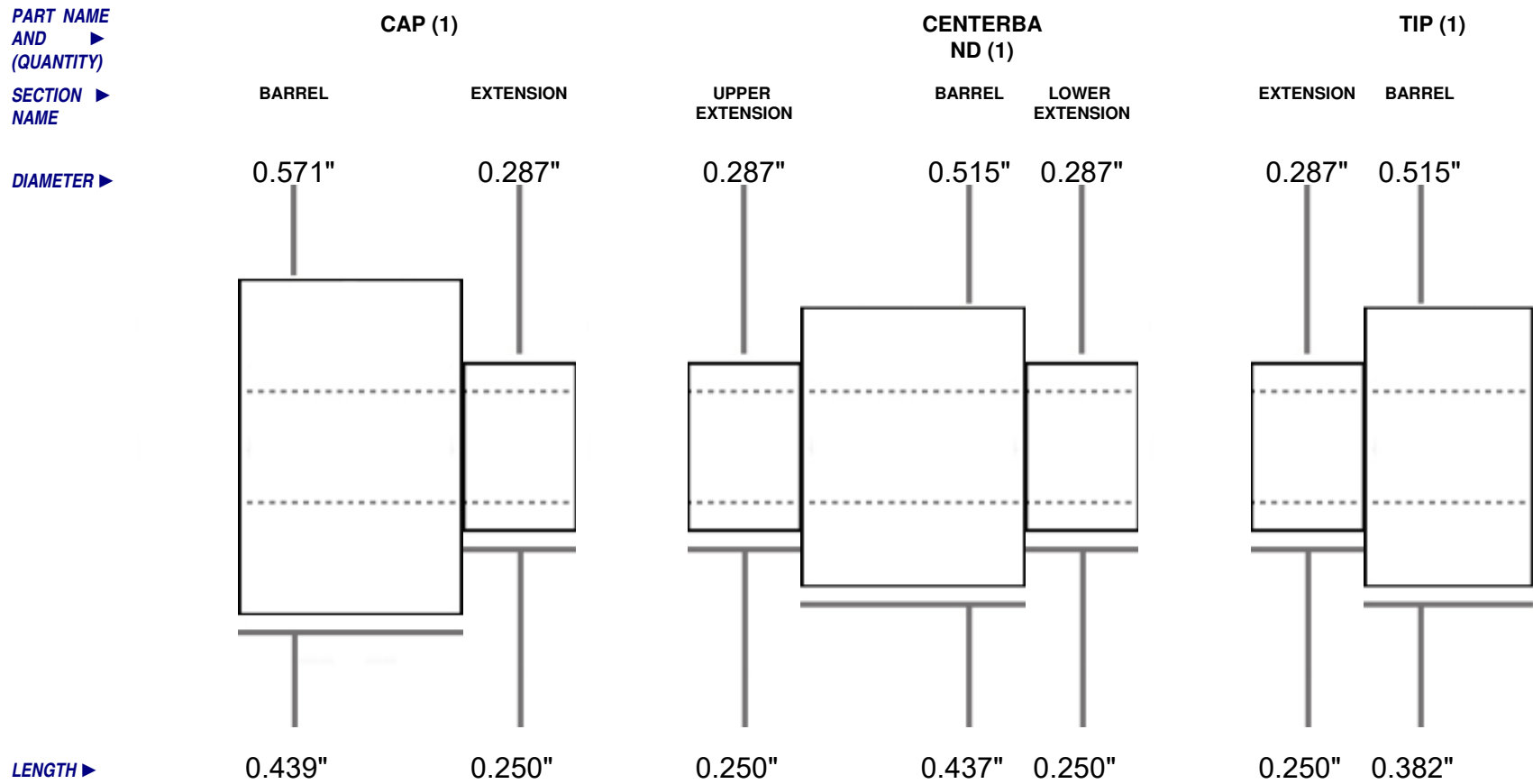

ASSOCIATED PKMAY(XX)

KITS:

PICTURE IS AN APPROXIMATE REPRESENTATION. NOT TO EXACT SCALE OR PROPORTION. ALL MEASUREMENTS IN INCHES. BUSHING DIAMETERS (TOP ROW) ARE OPTIMAL AND SHOULD VARY BY NO MORE THAN .002" WHEN NEW.

ID NUMBER PKMBEADY **TYPE:** BUSHING

NOTES: ALL 5 PIECES SAME DIMENSION. THRU HOLE IS .125"

NUMBER OF PARTS 5

THRU HOLE STANDARD (0.248')

**PART NAME
AND ►
(QUANTITY)**

BARREL (5)

**SECTION ►
NAME**

BARREL

DIAMETER ►

0.215"



LENGTH ►

0.188"

**ASSOCIATED
KITS:**

PICTURE IS AN APPROXIMATE REPRESENTATION. NOT TO EXACT SCALE OR PROPORTION. ALL MEASUREMENTS IN INCHES. BUSHING DIAMETERS (TOP ROW) ARE OPTIMAL AND SHOULD VARY BY NO MORE THAN .002" WHEN NEW.

ID NUMBER PKMBL105 **TYPE:** INTERNAL BUSHING

NOTES: THIS PART THREADS ONTO THE END OF THE "BIG GRABBER" MANDREL FOR STABILIZING THE END OF CLOSED END PROJECTS WITH 10.5MM TUBES.

NUMBER OF PARTS 1

THRU HOLE M6 X 1.0 FEMALE THREADED BLIND HOLE

PART NAME AND (QUANTITY) ▶

SECTION NAME ▶

DIAMETER ▶

END BUSHING (1)

OUTER DIAMETER

0.376"

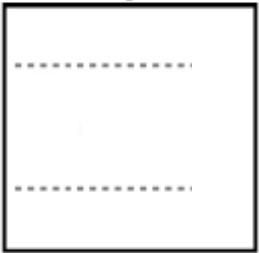

0.437"

LENGTH ▶

ASSOCIATED KITS:

PICTURE IS AN APPROXIMATE REPRESENTATION. NOT TO EXACT SCALE OR PROPORTION. ALL MEASUREMENTS IN INCHES. BUSHING DIAMETERS (TOP ROW) ARE OPTIMAL AND SHOULD VARY BY NO MORE THAN .002" WHEN NEW.

ID NUMBER PKMBL125 **TYPE:** INTERNAL BUSHING

NUMBER OF PARTS 1

THRU HOLE M6 X 1.0 FEMALE THREADED BLIND HOLE

NOTES: THIS PART THREADS ONTO THE END OF THE "BIG GRABBER" MANDREL FOR STABILIZING THE END OF CLOSED END PROJECTS WITH 12.5MM TUBES.

PART NAME AND (QUANTITY) ▶

SECTION NAME ▶

DIAMETER ▶

END BUSHING (1)

OUTER DIMENSIONS

0.452"

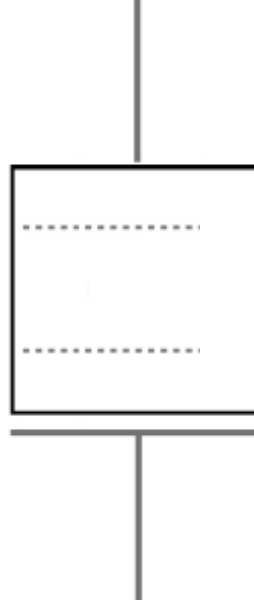

LENGTH ▶

0.437"

ASSOCIATED KITS:

PICTURE IS AN APPROXIMATE REPRESENTATION. NOT TO EXACT SCALE OR PROPORTION. ALL MEASUREMENTS IN INCHES. BUSHING DIAMETERS (TOP ROW) ARE OPTIMAL AND SHOULD VARY BY NO MORE THAN .002" WHEN NEW.

ID NUMBER PKMBL1532 **TYPE:** INTERNAL BUSHING

NUMBER OF PARTS 1

THRU HOLE M6 X 1.0 FEMALE THREADED BLIND HOLE

NOTES: THIS PART THREADS ONTO THE END OF THE "BIG GRABBER" MANDREL FOR STABILIZING THE END OF CLOSED END PROJECTS WITH 15/32" TUBES.

PART NAME AND (QUANTITY) ▶

SECTION NAME ▶

DIAMETER ▶

END BUSHING (1)

OUTER DIAMETER

0.427"

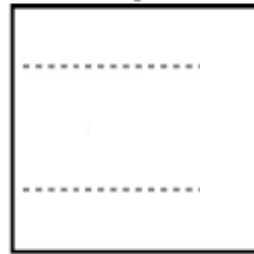

0.437"

LENGTH ▶

ASSOCIATED KITS:

PICTURE IS AN APPROXIMATE REPRESENTATION. NOT TO EXACT SCALE OR PROPORTION. ALL MEASUREMENTS IN INCHES. BUSHING DIAMETERS (TOP ROW) ARE OPTIMAL AND SHOULD VARY BY NO MORE THAN .002" WHEN NEW.

ID NUMBER PKMBL2564 **TYPE:** INTERNAL BUSHING

NUMBER OF PARTS 0

THRU HOLE M6 X 1.0 FEMALE THREADED BLIND HOLE

NOTES: THIS PART THREADS ONTO THE END OF THE "BIG GRABBER" MANDREL FOR STABILIZING THE END OF CLOSED END PROJECTS WITH 25/64" TUBES.

PART NAME AND (QUANTITY) ▶

SECTION NAME ▶

DIAMETER ▶

END BUSHING (1)

OUTER DIAMETER

0.356"



LENGTH ▶

0.436"

ASSOCIATED KITS:

PICTURE IS AN APPROXIMATE REPRESENTATION. NOT TO EXACT SCALE OR PROPORTION. ALL MEASUREMENTS IN INCHES. BUSHING DIAMETERS (TOP ROW) ARE OPTIMAL AND SHOULD VARY BY NO MORE THAN .002" WHEN NEW.

ID NUMBER PKMBL3164 **TYPE:** INTERNAL BUSHING

NUMBER OF PARTS 1

THRU HOLE M6 X 1.0 FEMALE THREADED BLIND HOLE

NOTES: THIS PART THREADS ONTO THE END OF THE "BIG GRABBER" MANDREL FOR STABILIZING THE END OF CLOSED END PROJECTS WITH 3/16" TUBES.

PART NAME AND (QUANTITY) ▶

SECTION NAME ▶

DIAMETER ▶

END BUSHING (1)

OUTER DIAMETER

0.447"



LENGTH ▶

0.437"

ASSOCIATED KITS:

PICTURE IS AN APPROXIMATE REPRESENTATION. NOT TO EXACT SCALE OR PROPORTION. ALL MEASUREMENTS IN INCHES. BUSHING DIAMETERS (TOP ROW) ARE OPTIMAL AND SHOULD VARY BY NO MORE THAN .002" WHEN NEW.

ID NUMBER PKMBL3364 **TYPE:** INTERNAL BUSHING

NUMBER OF PARTS 1

THRU HOLE M6 X 1.0 FEMALE THREADED BLIND HOLE

NOTES: THIS PART THREADS ONTO THE END OF THE "BIG GRABBER" MANDREL FOR STABILIZING THE END OF CLOSED END PROJECTS WITH 33/64" TUBES.

PART NAME AND (QUANTITY) ▶

SECTION NAME ▶

DIAMETER ▶

END BUSHING (1)

OUTER DIAMETER

0.490"

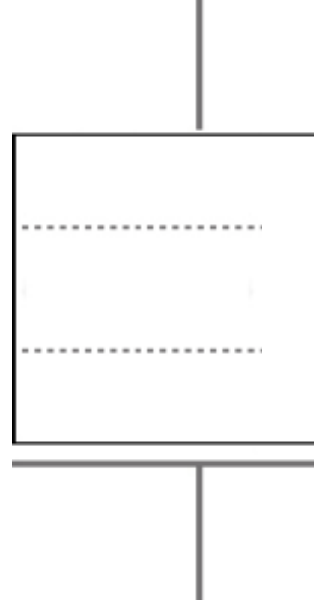

0.438"

LENGTH ▶

ASSOCIATED KITS:

PICTURE IS AN APPROXIMATE REPRESENTATION. NOT TO EXACT SCALE OR PROPORTION. ALL MEASUREMENTS IN INCHES. BUSHING DIAMETERS (TOP ROW) ARE OPTIMAL AND SHOULD VARY BY NO MORE THAN .002" WHEN NEW.

ID NUMBER PKMBL916 **TYPE:** INTERNAL BUSHING

NUMBER OF PARTS 1

THRU HOLE M6 X 1.0 FEMALE THREADED BLIND HOLE

NOTES: THIS PART THREADS ONTO THE END OF THE "BIG GRABBER" MANDREL FOR STABILIZING THE END OF CLOSED END PROJECTS WITH 9/16" TUBES.

PART NAME AND (QUANTITY) ▶

SECTION NAME ▶

DIAMETER ▶

END BUSHING (1)

OUTER DIAMETER

0.531"

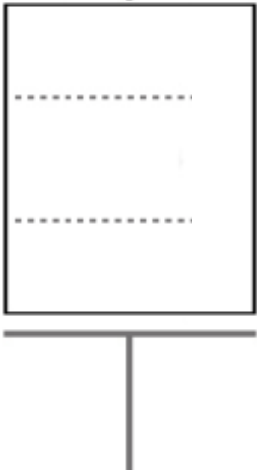

LENGTH ▶

0.437"

ASSOCIATED KITS:

PICTURE IS AN APPROXIMATE REPRESENTATION. NOT TO EXACT SCALE OR PROPORTION. ALL MEASUREMENTS IN INCHES. BUSHING DIAMETERS (TOP ROW) ARE OPTIMAL AND SHOULD VARY BY NO MORE THAN .002" WHEN NEW.

ID NUMBER PKMBLCBU **TYPE:** DRILLING GUIDE

NOTES: THIS PART IS USED AS A DRILL GUIDE FOR CLOSED END ROLLERBALL KITS WITH 10.5MM LOWER TUBES TO CREATE A RECESS FOR ROLLERBALL SPRING.

NUMBER OF PARTS 1

THRU HOLE .28"

PART NAME AND (QUANTITY)

GUIDE (1)

SECTION NAME

DIMENSIONS

DIAMETER

0.404"



LENGTH

1.875"

ASSOCIATED KITS:

PICTURE IS AN APPROXIMATE REPRESENTATION. NOT TO EXACT SCALE OR PROPORTION. ALL MEASUREMENTS IN INCHES. BUSHING DIAMETERS (TOP ROW) ARE OPTIMAL AND SHOULD VARY BY NO MORE THAN .002" WHEN NEW.

ID NUMBER PKM-BUSH3 **TYPE:** BUSHING
NUMBER OF PARTS 3
THRU HOLE STANDARD(0.248")

NOTES: ALL 3 BUSHINGS ARE SAME DIMENSIONS. 5 OF THESE BUSHINGS COME WITH MOST PSI MANDRELS. ALSO CALLED A "STANDARD 7MM BUSHING". ALSO USED FOR THE TIP ON COMFORT PENS WHEN COMFORT GRIP IS NOT USED.

PART NAME AND (QUANTITY) ▶
SECTION NAME ▶
DIAMETER ▶

STANDARD BUSHING (3)

BARREL DIAMETER

0.333"



0.375"

LENGTH ▶

ASSOCIATED KITS: MCM-CF(XX), PK30M(XX), PKBELL(XX), PKCCP(XX), PKDART1(XX), PKDART2(XX), PKDETACH(XX), PKGVCL(XX), PKGVTW(XX), PKKEY(XX), PKLO(XX), PK-LTPULL(XX), PKMAG(XX), PKMINI(XX), PKORN(XX), PK-PCL(XX), PK-PEN(XX), PKSCRATCH(XX), PKSLFUN(XX), PKSLFUPL(XX), PKSLX(XX), PKSLX(XX)2, PKSTPEN(XX), PKTEACH(XX), PKTPC(XX), PKTPN(XX), PKTS2(XX), PKTSCCP(XX), PKTSPEN(XX), PKTST(XX)

PICTURE IS AN APPROXIMATE REPRESENTATION. NOT TO EXACT SCALE OR PROPORTION. ALL MEASUREMENTS IN INCHES. BUSHING DIAMETERS (TOP ROW) ARE OPTIMAL AND SHOULD VARY BY NO MORE THAN .002" WHEN NEW.

ID NUMBER PKMINCLKBU **TYPE:** BUSHING

NOTES:

NUMBER OF PARTS 2

THRU HOLE STANDARD (0.248')

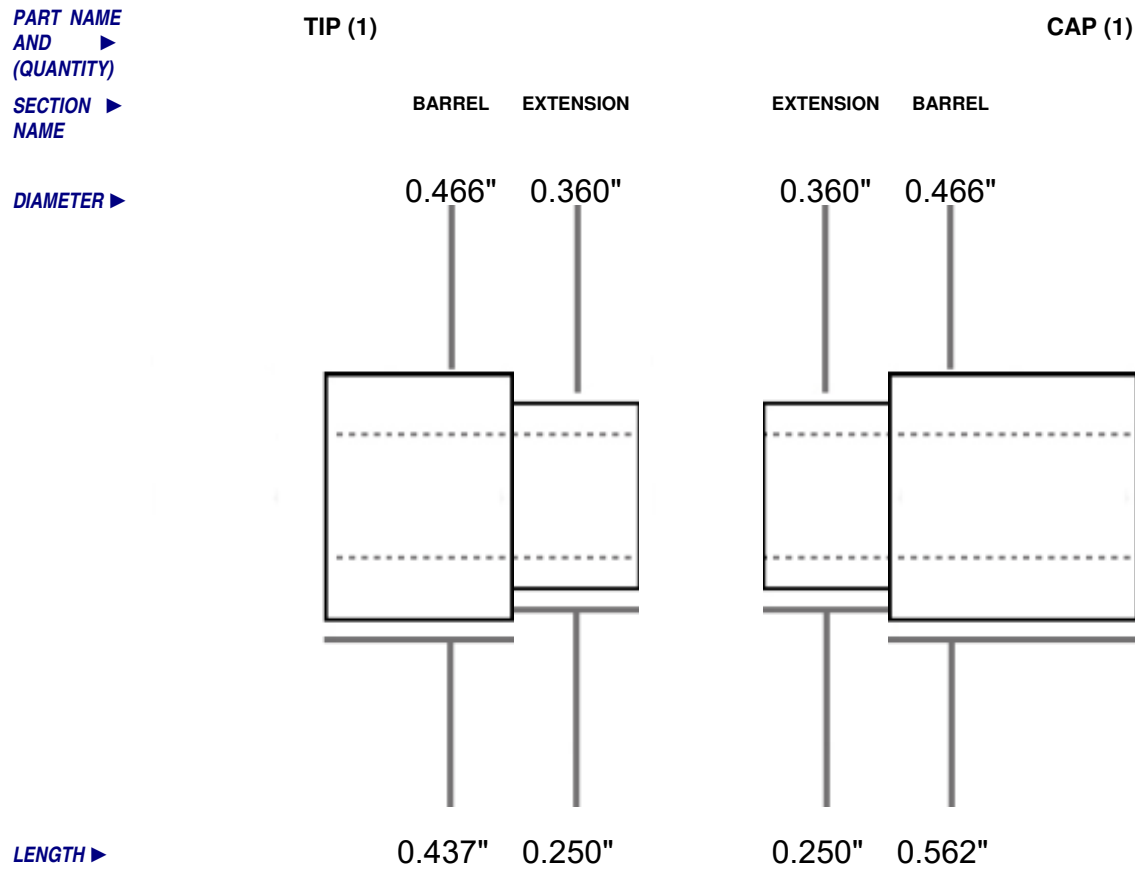

ASSOCIATED PKMINCLK(XX)

KITS:

PICTURE IS AN APPROXIMATE REPRESENTATION. NOT TO EXACT SCALE OR PROPORTION. ALL MEASUREMENTS IN INCHES. BUSHING DIAMETERS (TOP ROW) ARE OPTIMAL AND SHOULD VARY BY NO MORE THAN .002" WHEN NEW.

ID NUMBER PKMJJRCBU **TYPE:** BUSHING

NOTES: ONE BUSHING IS USED FOR EACH BARREL

NUMBER OF PARTS 2

THRU HOLE STANDARD (0.248")

PART NAME AND (QUANTITY)
SECTION NAME

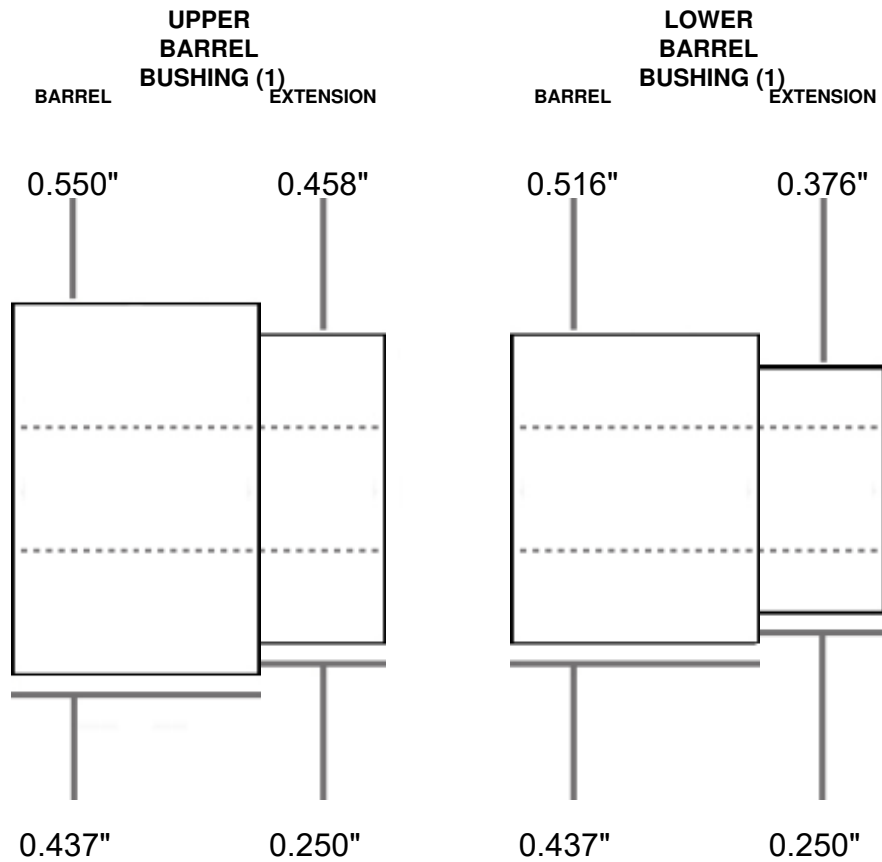

DIAMETER

LENGTH

ASSOCIATED PKMAJCF(XX), PKMAJCR(XX)
KITS:

PICTURE IS AN APPROXIMATE REPRESENTATION. NOT TO EXACT SCALE OR PROPORTION. ALL MEASUREMENTS IN INCHES. BUSHING DIAMETERS (TOP ROW) ARE OPTIMAL AND SHOULD VARY BY NO MORE THAN .002" WHEN NEW.

ID NUMBER PKMONT2-BU **TYPE:** BUSHING

NOTES:

NUMBER OF PARTS 3

THRU HOLE STANDARD(0.248")

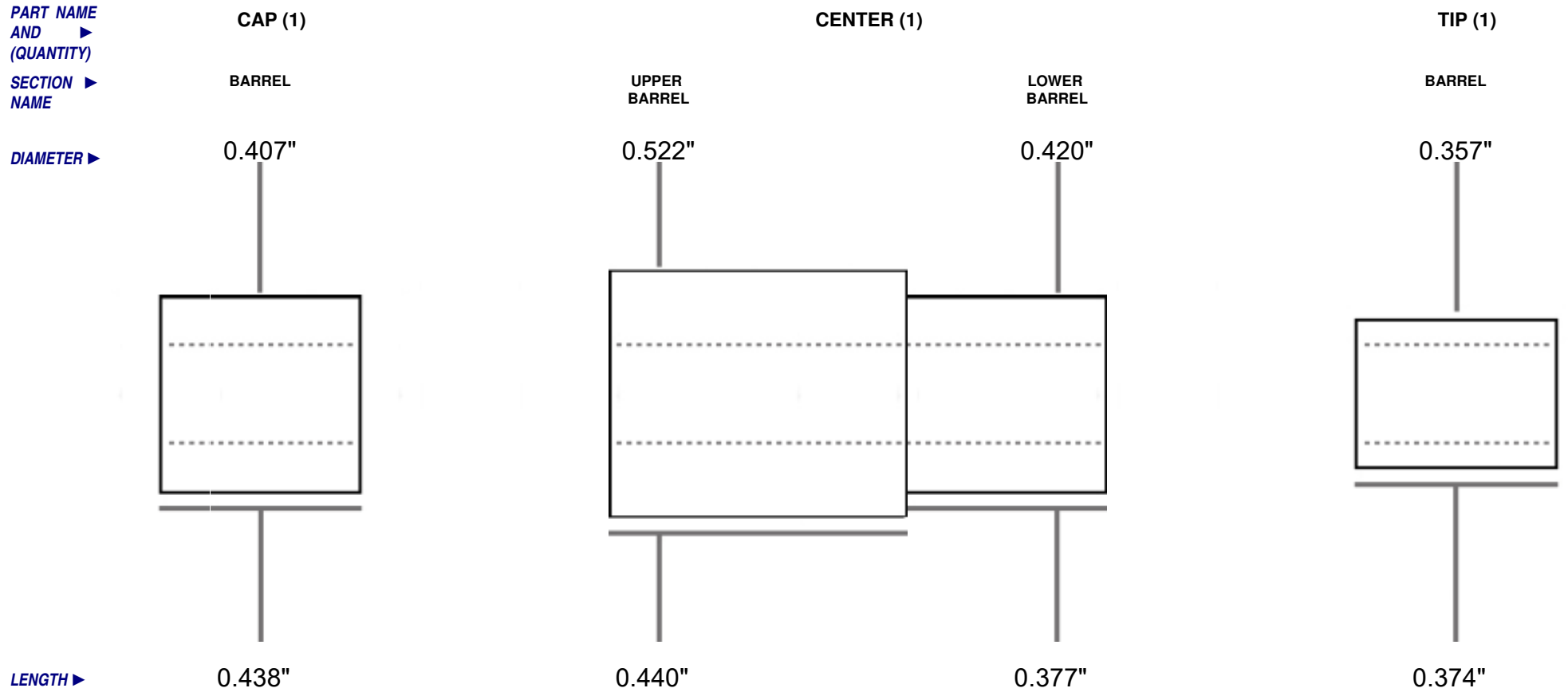

ASSOCIATED PKMONT2(XX), PKMONTLO6(XX), PKMTMIN(XX)

KITS:

PICTURE IS AN APPROXIMATE REPRESENTATION. NOT TO EXACT SCALE OR PROPORTION. ALL MEASUREMENTS IN INCHES. BUSHING DIAMETERS (TOP ROW) ARE OPTIMAL AND SHOULD VARY BY NO MORE THAN .002" WHEN NEW.

ID NUMBER PKMONT3BU **TYPE:** BUSHING

NOTES:

NUMBER OF PARTS 3

THRU HOLE STANDARD (0.248')

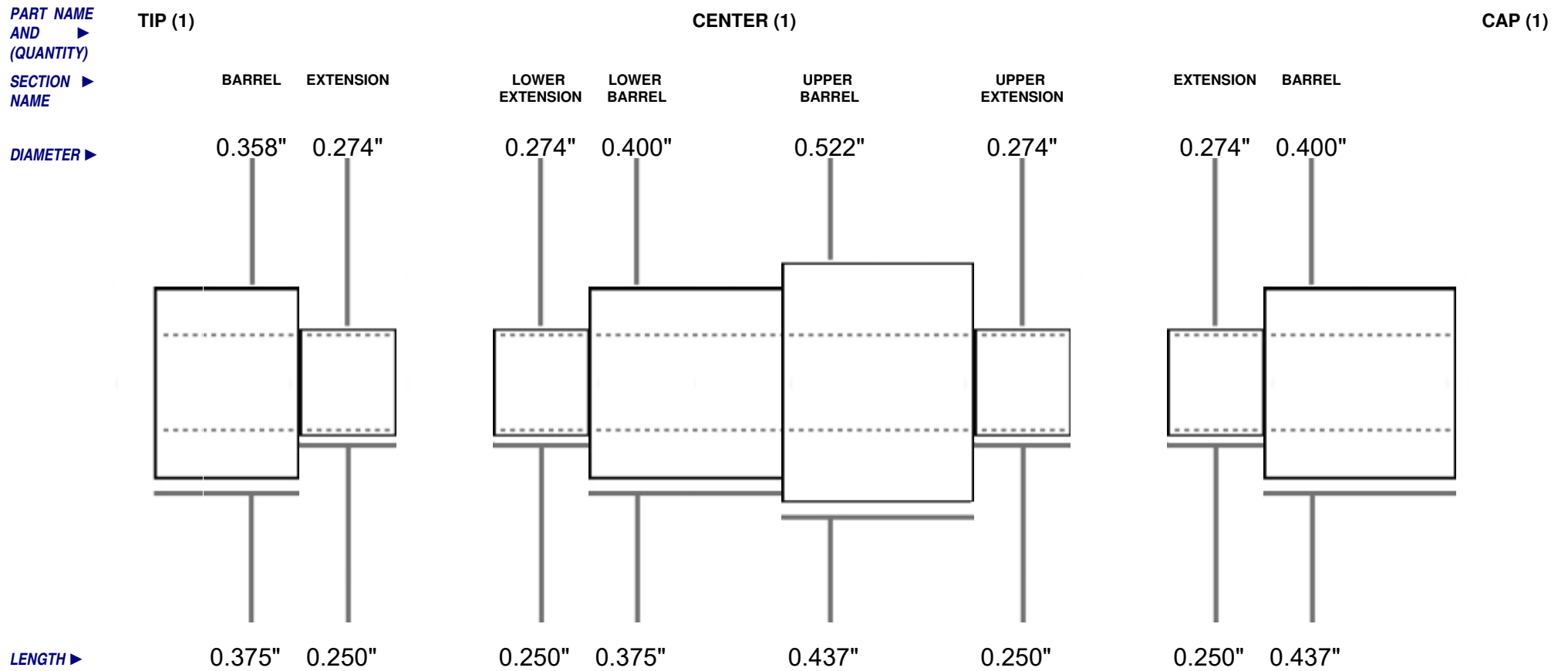

ASSOCIATED PKMONT3(XX), PKMONT-FP(DD), PKMONT-RP(DD), PKMONTRP2(XX)

KITS:

PICTURE IS AN APPROXIMATE REPRESENTATION. NOT TO EXACT SCALE OR PROPORTION. ALL MEASUREMENTS IN INCHES. BUSHING DIAMETERS (TOP ROW) ARE OPTIMAL AND SHOULD VARY BY NO MORE THAN .002" WHEN NEW.

ID NUMBER PKMONT-BU **TYPE:** BUSHING

NUMBER OF PARTS 3

THRU HOLE STANDARD (0.248')

NOTES: PKLO2 USES LOWER BARREL / TENON SECTION FOR THE BLADE COUPLER AND THE CAP BUSHING FOR THE CAP END.

CENTER CAN BE REPLACED WITH PKMONT-BUX FOR EASIER TURNING OF THE TENON.

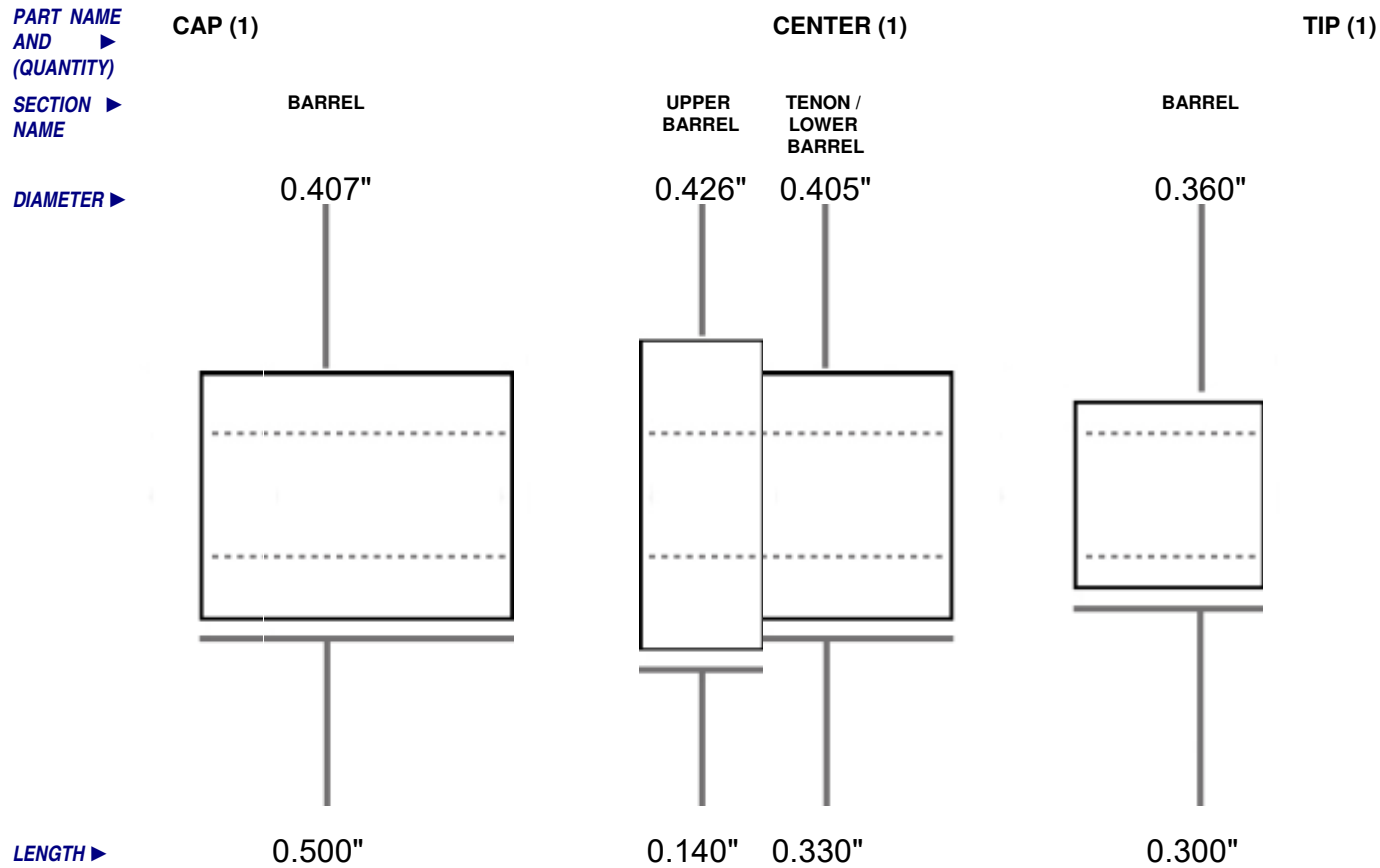

ASSOCIATED PKLO2(XX), PKMONT(XX), PKMTFUN(XX)
KITS:

PICTURE IS AN APPROXIMATE REPRESENTATION. NOT TO EXACT SCALE OR PROPORTION. ALL MEASUREMENTS IN INCHES. BUSHING DIAMETERS (TOP ROW) ARE OPTIMAL AND SHOULD VARY BY NO MORE THAN .002" WHEN NEW.

ID NUMBER PKMONT-BU2 **TYPE:** BUSHING

NOTES:

NUMBER OF PARTS 3

THRU HOLE NO THROUGH HOLE ON END PIECES. CENTER PECE HAS 0.15" HOLE

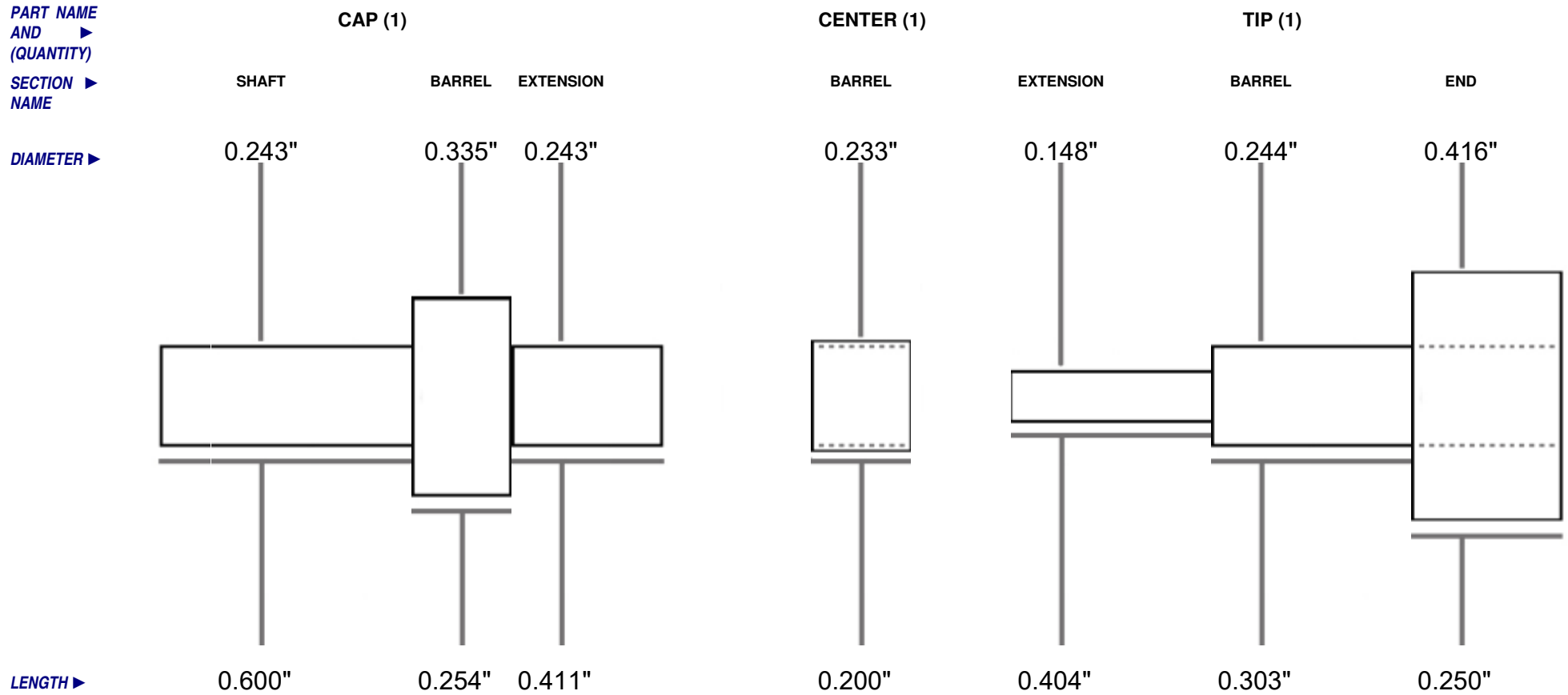

ASSOCIATED KITS:

PICTURE IS AN APPROXIMATE REPRESENTATION. NOT TO EXACT SCALE OR PROPORTION. ALL MEASUREMENTS IN INCHES. BUSHING DIAMETERS (TOP ROW) ARE OPTIMAL AND SHOULD VARY BY NO MORE THAN .002" WHEN NEW.

ID NUMBER PKMONT-BUX **TYPE:** BUSHING

NUMBER OF PARTS 2

THRU HOLE CENTER IS STANDARD(0.248). SLEEVE FITS OVER CENTER TENON.

NOTES: REPLACES CENTER BUSHING FOR PKMONT-BU TO SIZE THE UPPER BLANK FOR TENON WITHOUT FLIPPING OR USING A SPARE CENTERBAND. PKMONT-BU AND PKMONT-BUX CAN BE BOUGHT AS A COMBINATION UNDER #PKMONTBUY.

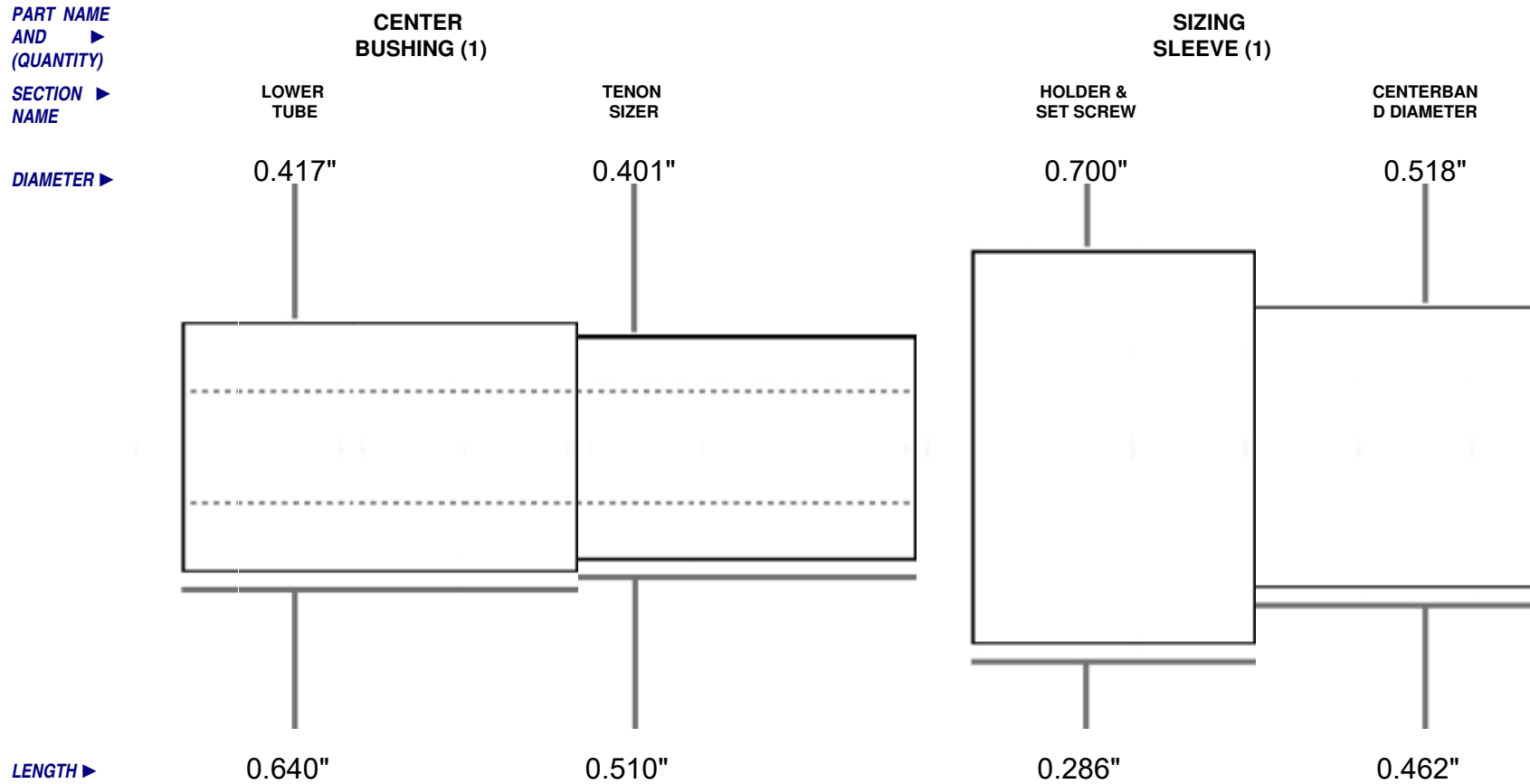

ASSOCIATED PKMONT-BU
KITS:

PICTURE IS AN APPROXIMATE REPRESENTATION. NOT TO EXACT SCALE OR PROPORTION. ALL MEASUREMENTS IN INCHES. BUSHING DIAMETERS (TOP ROW) ARE OPTIMAL AND SHOULD VARY BY NO MORE THAN .002" WHEN NEW.

ID NUMBER PKMONTL2BU **TYPE:** BUSHING

NOTES: CAP/TIP SAME DIMENSIONS

NUMBER OF PARTS 3

THRU HOLE STANDARD (0.248')

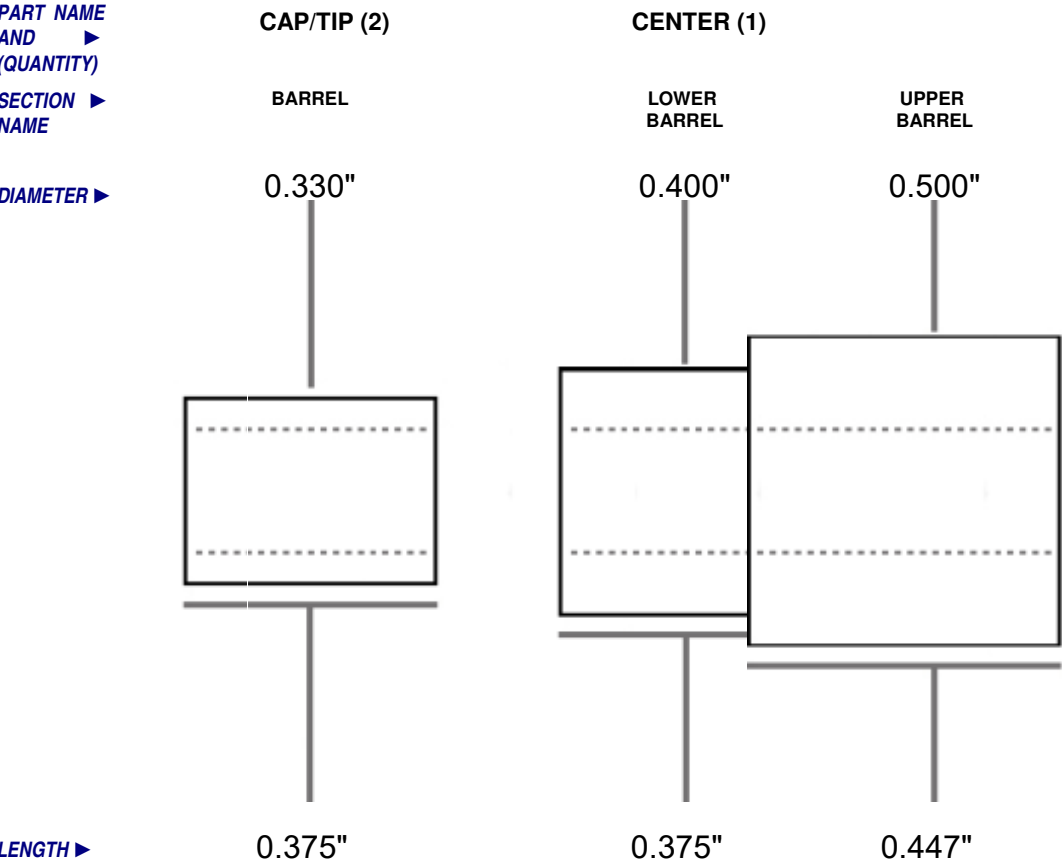

ASSOCIATED KITS:

PICTURE IS AN APPROXIMATE REPRESENTATION. NOT TO EXACT SCALE OR PROPORTION. ALL MEASUREMENTS IN INCHES. BUSHING DIAMETERS (TOP ROW) ARE OPTIMAL AND SHOULD VARY BY NO MORE THAN .002" WHEN NEW.

ID NUMBER PKMONTPRBU **TYPE:** BUSHING

NOTES:

NUMBER OF PARTS 3

THRU HOLE STANDARD (0.248')

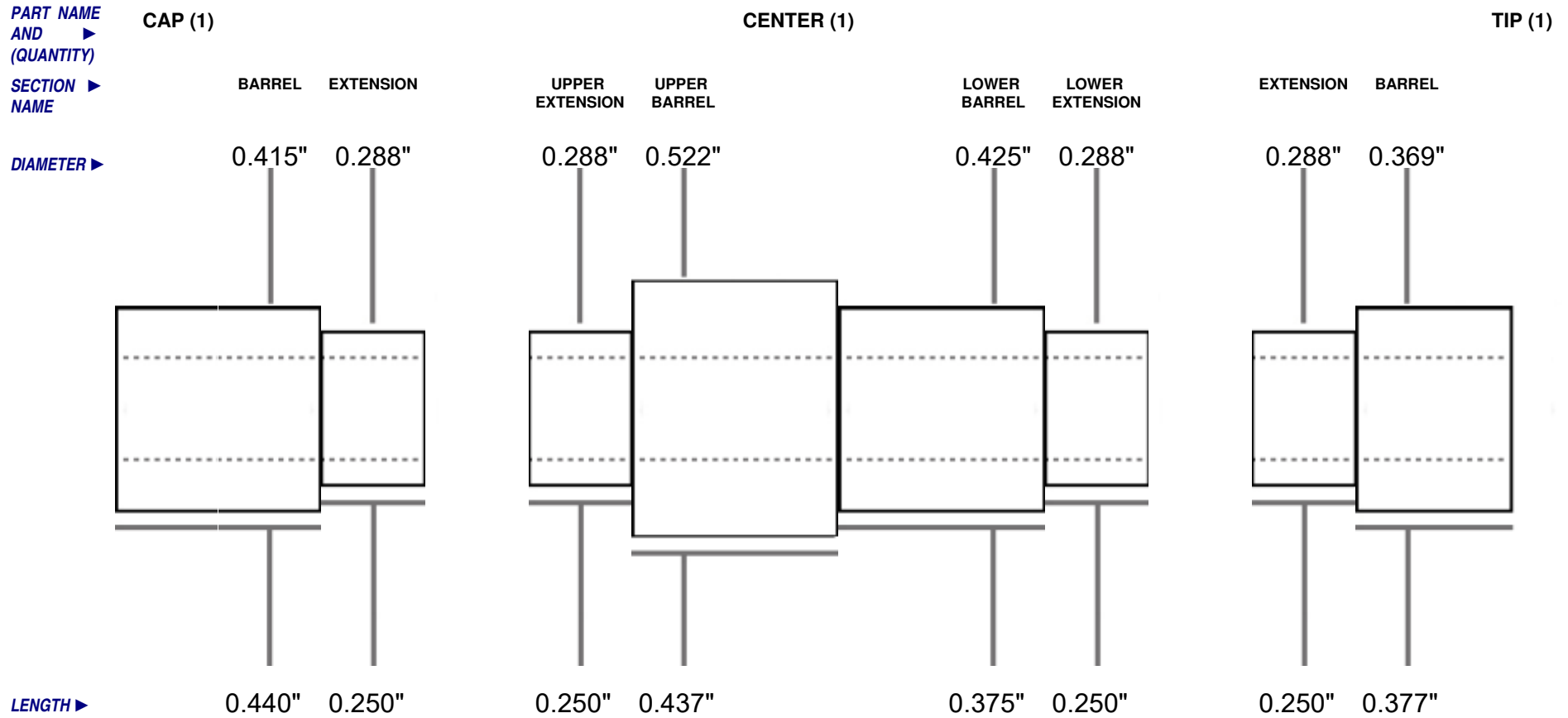

ASSOCIATED PKMONT2PAR(XX)

KITS:

PICTURE IS AN APPROXIMATE REPRESENTATION. NOT TO EXACT SCALE OR PROPORTION. ALL MEASUREMENTS IN INCHES. BUSHING DIAMETERS (TOP ROW) ARE OPTIMAL AND SHOULD VARY BY NO MORE THAN .002" WHEN NEW.

ID NUMBER PKMOONBU **TYPE:** BUSHING

NOTES:

NUMBER OF PARTS 2

THRU HOLE STANDARD (0.248')

PART NAME AND (QUANTITY)

SECTION NAME

DIAMETER

LENGTH

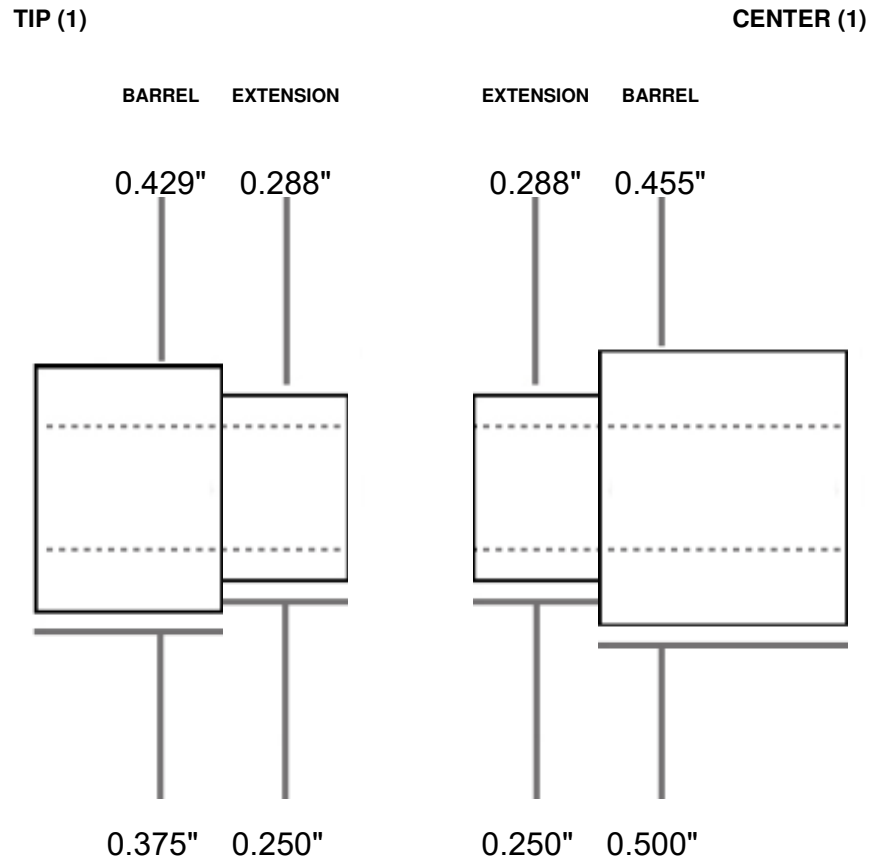

ASSOCIATED PKMOON(XX)
KITS:

PICTURE IS AN APPROXIMATE REPRESENTATION. NOT TO EXACT SCALE OR PROPORTION. ALL MEASUREMENTS IN INCHES. BUSHING DIAMETERS (TOP ROW) ARE OPTIMAL AND SHOULD VARY BY NO MORE THAN .002" WHEN NEW.

ID NUMBER PKMSPBU

TYPE: BUSHING

NOTES:

NUMBER OF PARTS 2

THRU HOLE STANDARD (0.248')

PART NAME AND (QUANTITY)

SECTION NAME

DIAMETER

SPOON SIDE (1)

BARREL

0.460"



0.500"

CAP SIDE (1)

BARREL

0.440"



0.375"

LENGTH

ASSOCIATED KITS: PKMSPN(XX)

PICTURE IS AN APPROXIMATE REPRESENTATION. NOT TO EXACT SCALE OR PROPORTION. ALL MEASUREMENTS IN INCHES. BUSHING DIAMETERS (TOP ROW) ARE OPTIMAL AND SHOULD VARY BY NO MORE THAN .002" WHEN NEW.

ID NUMBER PKMT7BU

TYPE: BUSHING

NOTES: BOTH SIDES HAVE SAME DIAMETER

NUMBER OF PARTS 2

THRU HOLE STANDARD (0.248')

PART NAME AND (QUANTITY)

SECTION NAME

DIAMETER

END BUSHING (2)

BARREL

0.360"



0.437"

LENGTH

ASSOCIATED PKMT7(XX) KITS:

PICTURE IS AN APPROXIMATE REPRESENTATION. NOT TO EXACT SCALE OR PROPORTION. ALL MEASUREMENTS IN INCHES. BUSHING DIAMETERS (TOP ROW) ARE OPTIMAL AND SHOULD VARY BY NO MORE THAN .002" WHEN NEW.

ID NUMBER PKMUSBU

TYPE: BUSHING

NOTES:

NUMBER OF PARTS 3

THRU HOLE STANDARD (0.248')

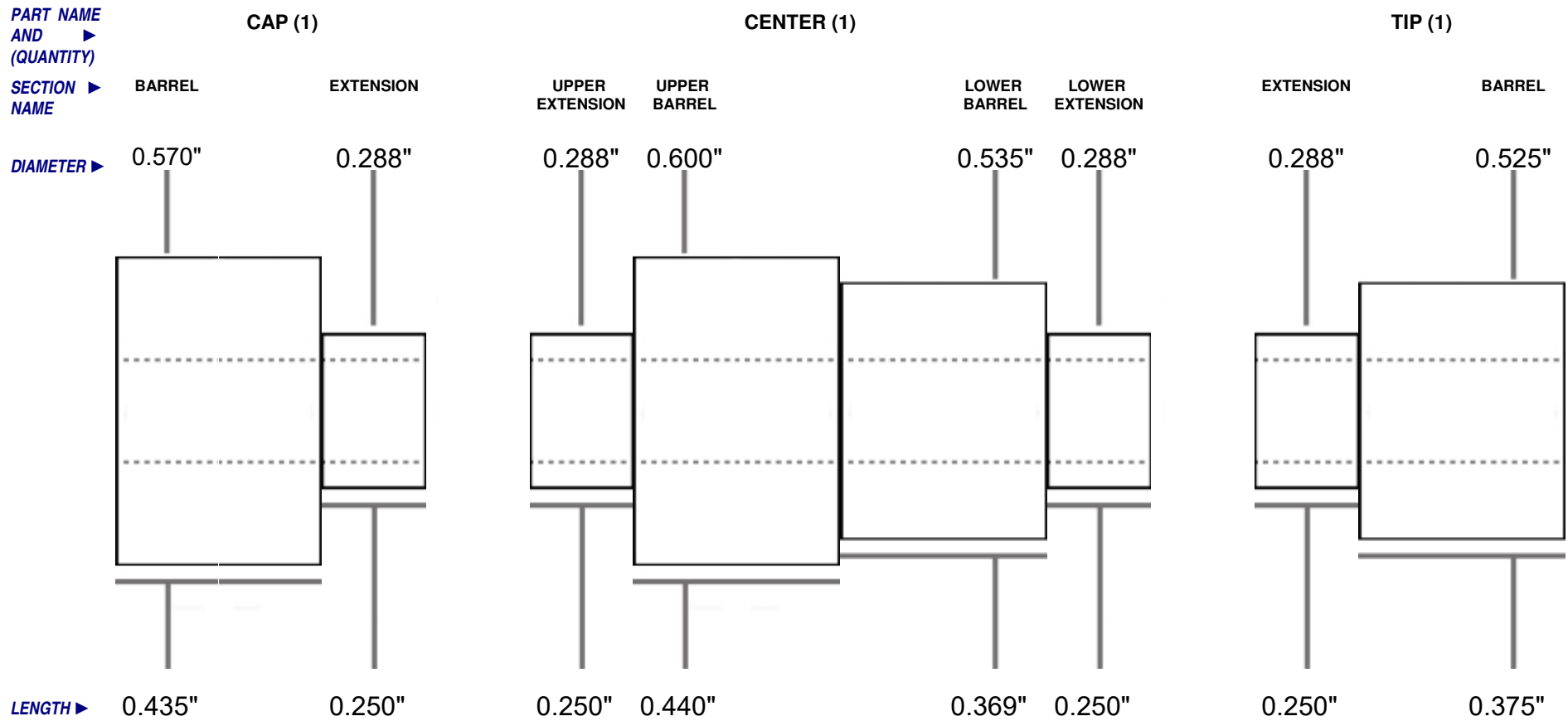

ASSOCIATED PKMUS(XX)

KITS:

PICTURE IS AN APPROXIMATE REPRESENTATION. NOT TO EXACT SCALE OR PROPORTION. ALL MEASUREMENTS IN INCHES. BUSHING DIAMETERS (TOP ROW) ARE OPTIMAL AND SHOULD VARY BY NO MORE THAN .002" WHEN NEW.

ID NUMBER PKMUSRBU **TYPE:** BUSHING

NOTES:

NUMBER OF PARTS 3

THRU HOLE STANDARD (0.248')

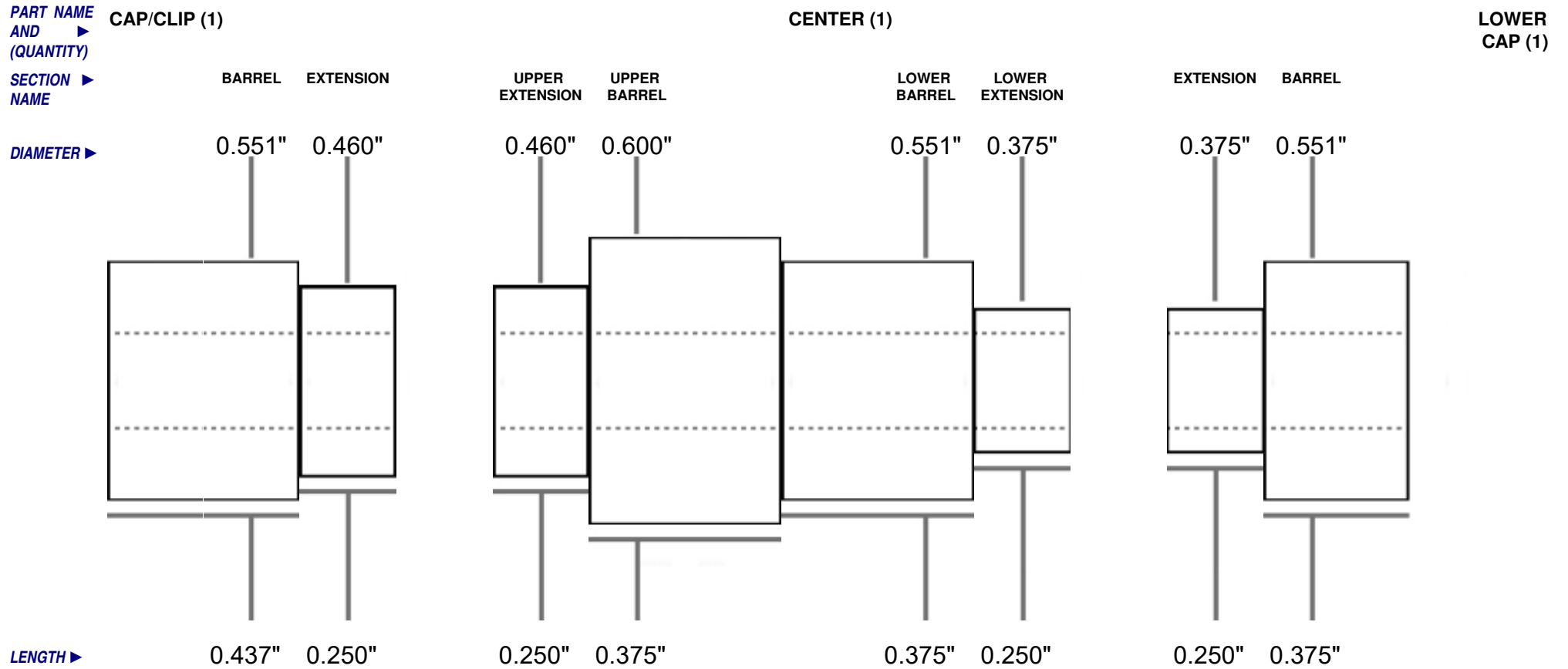

ASSOCIATED PKMUSF(XX), PKMUSR(XX)
KITS:

PICTURE IS AN APPROXIMATE REPRESENTATION. NOT TO EXACT SCALE OR PROPORTION. ALL MEASUREMENTS IN INCHES. BUSHING DIAMETERS (TOP ROW) ARE OPTIMAL AND SHOULD VARY BY NO MORE THAN .002" WHEN NEW.

ID NUMBER PKNICK-BU **TYPE:** BUSHING

NOTES: TIP AND CAP SAME DIMENSIONS

NUMBER OF PARTS 2

THRU HOLE STANDARD (0.248')

PART NAME AND (QUANTITY)

SECTION NAME

DIAMETER

LENGTH

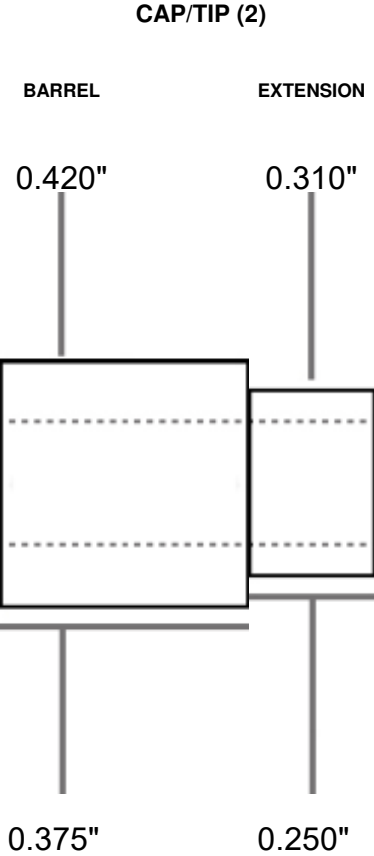

ASSOCIATED PKRYL(XX)
KITS:

PICTURE IS AN APPROXIMATE REPRESENTATION. NOT TO EXACT SCALE OR PROPORTION. ALL MEASUREMENTS IN INCHES. BUSHING DIAMETERS (TOP ROW) ARE OPTIMAL AND SHOULD VARY BY NO MORE THAN .002" WHEN NEW.

ID NUMBER PKOL2BU

TYPE: BUSHING

NOTES:

NUMBER OF PARTS 3

THRU HOLE STANDARD(0.248")

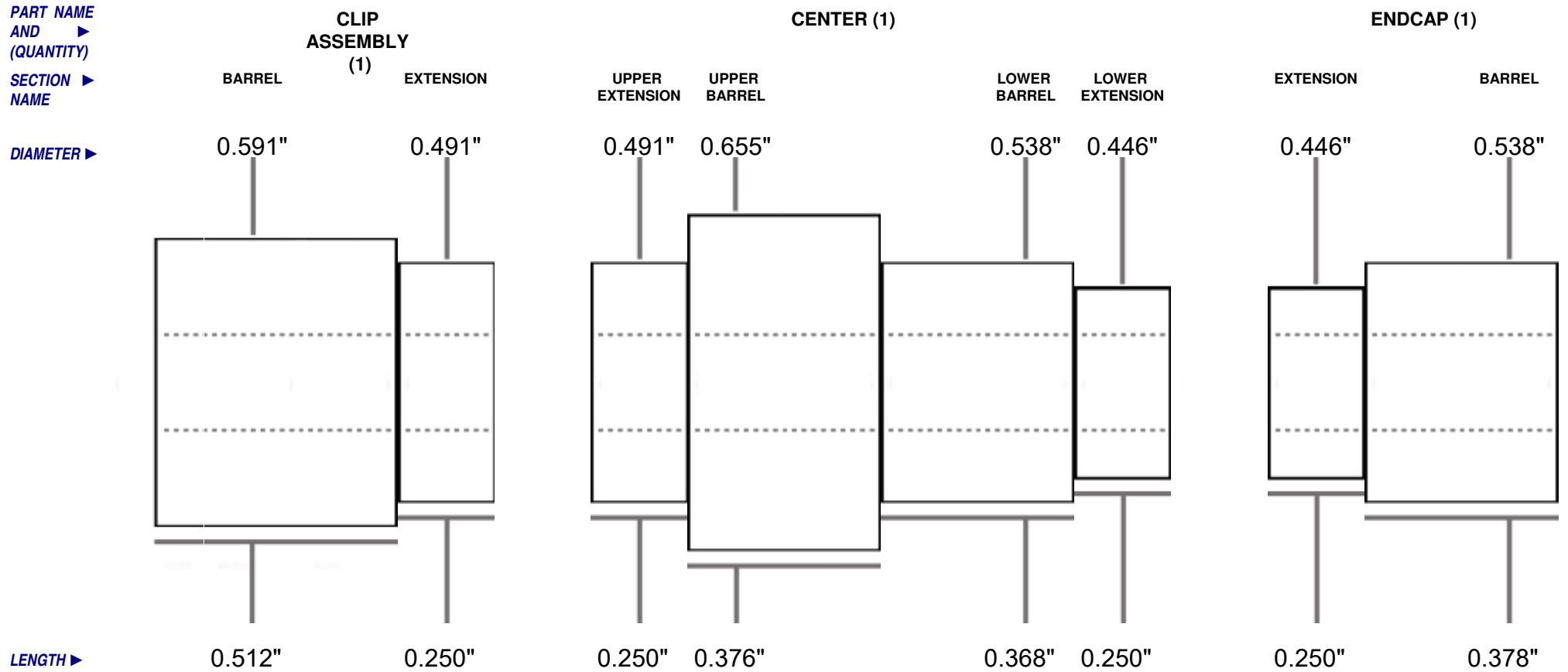

ASSOCIATED PKOL2FP(XX), PKOL2RB(XX)

KITS:

PICTURE IS AN APPROXIMATE REPRESENTATION. NOT TO EXACT SCALE OR PROPORTION. ALL MEASUREMENTS IN INCHES. BUSHING DIAMETERS (TOP ROW) ARE OPTIMAL AND SHOULD VARY BY NO MORE THAN .002" WHEN NEW.

ID NUMBER PKOLBTS **TYPE:** TRIMMING SLEEVE
NUMBER OF PARTS 2

NOTES: FITS STANDARD TUBES SIZED 33/64" (UPPER) AND 31/64" (LOWER)

THRU HOLE ACCEPTS 7MM TRIMMER SHAFT

PART NAME AND (QUANTITY)

UPPER TUBE (1)

LOWER TUBE (1)

SECTION NAME

EXTENSION

EXTENSION

DIAMETER

0.491"

0.445"

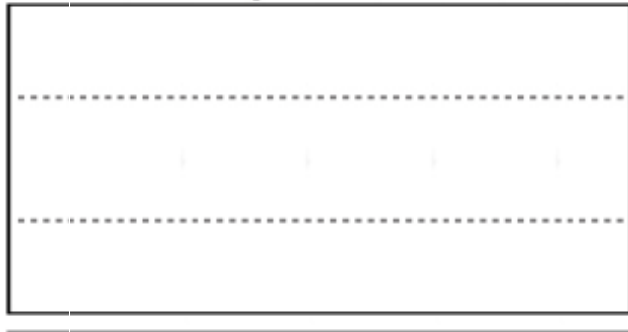

LENGTH

1.560"

1.877"

ASSOCIATED KITS:

PICTURE IS AN APPROXIMATE REPRESENTATION. NOT TO EXACT SCALE OR PROPORTION. ALL MEASUREMENTS IN INCHES. BUSHING DIAMETERS (TOP ROW) ARE OPTIMAL AND SHOULD VARY BY NO MORE THAN .002" WHEN NEW.

ID NUMBER PKOLCEBU **TYPE:** BUSHING

NOTES: ONE BUSHING IS USED FOR EACH BARREL

NUMBER OF PARTS 2

THRU HOLE STANDARD (0.248")

PART NAME AND (QUANTITY)
SECTION NAME

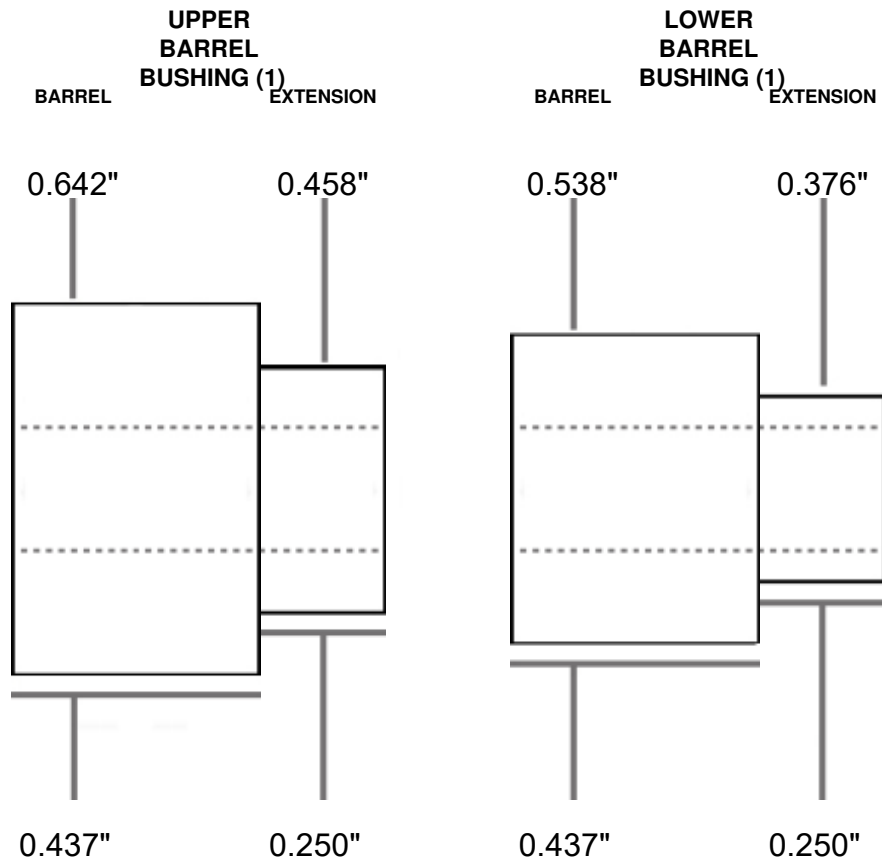

DIAMETER

LENGTH

ASSOCIATED KITS: PKOLCF(XX), PKOLCR(XX)

PICTURE IS AN APPROXIMATE REPRESENTATION. NOT TO EXACT SCALE OR PROPORTION. ALL MEASUREMENTS IN INCHES. BUSHING DIAMETERS (TOP ROW) ARE OPTIMAL AND SHOULD VARY BY NO MORE THAN .002" WHEN NEW.

ID NUMBER PKPAR10-B2 **TYPE:** BUSHING

NOTES:

NUMBER OF PARTS 3

THRU HOLE STANDARD(0.248")

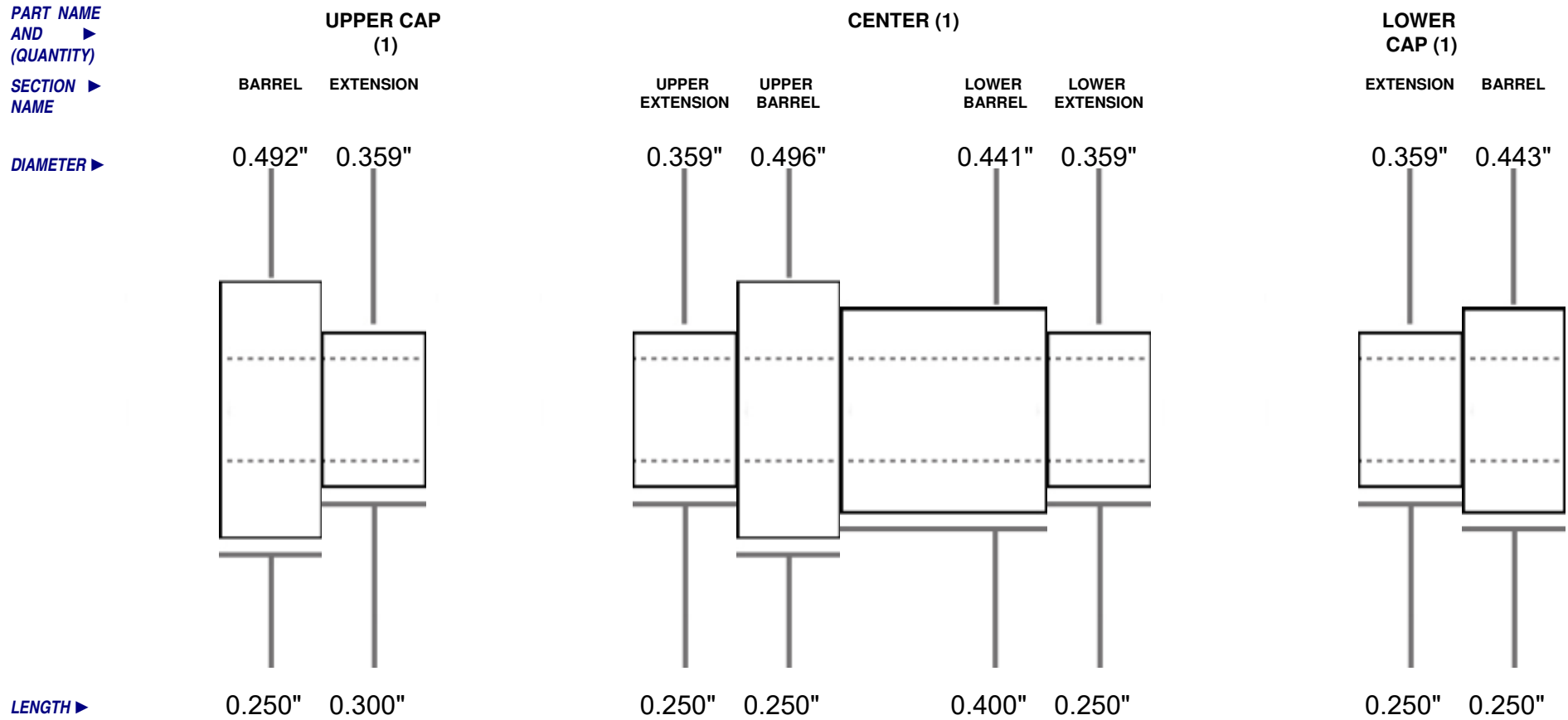

ASSOCIATED PKEL2F(XX), PKEL2R(XX), PKELP(XX), PKPAR10F(XX), PKPAR10R(XX)

KITS:

PICTURE IS AN APPROXIMATE REPRESENTATION. NOT TO EXACT SCALE OR PROPORTION. ALL MEASUREMENTS IN INCHES. BUSHING DIAMETERS (TOP ROW) ARE OPTIMAL AND SHOULD VARY BY NO MORE THAN .002" WHEN NEW.

ID NUMBER PKPARK-BU **TYPE:** BUSHING

NOTES:

NUMBER OF PARTS 3

THRU HOLE STANDARD(0.248")

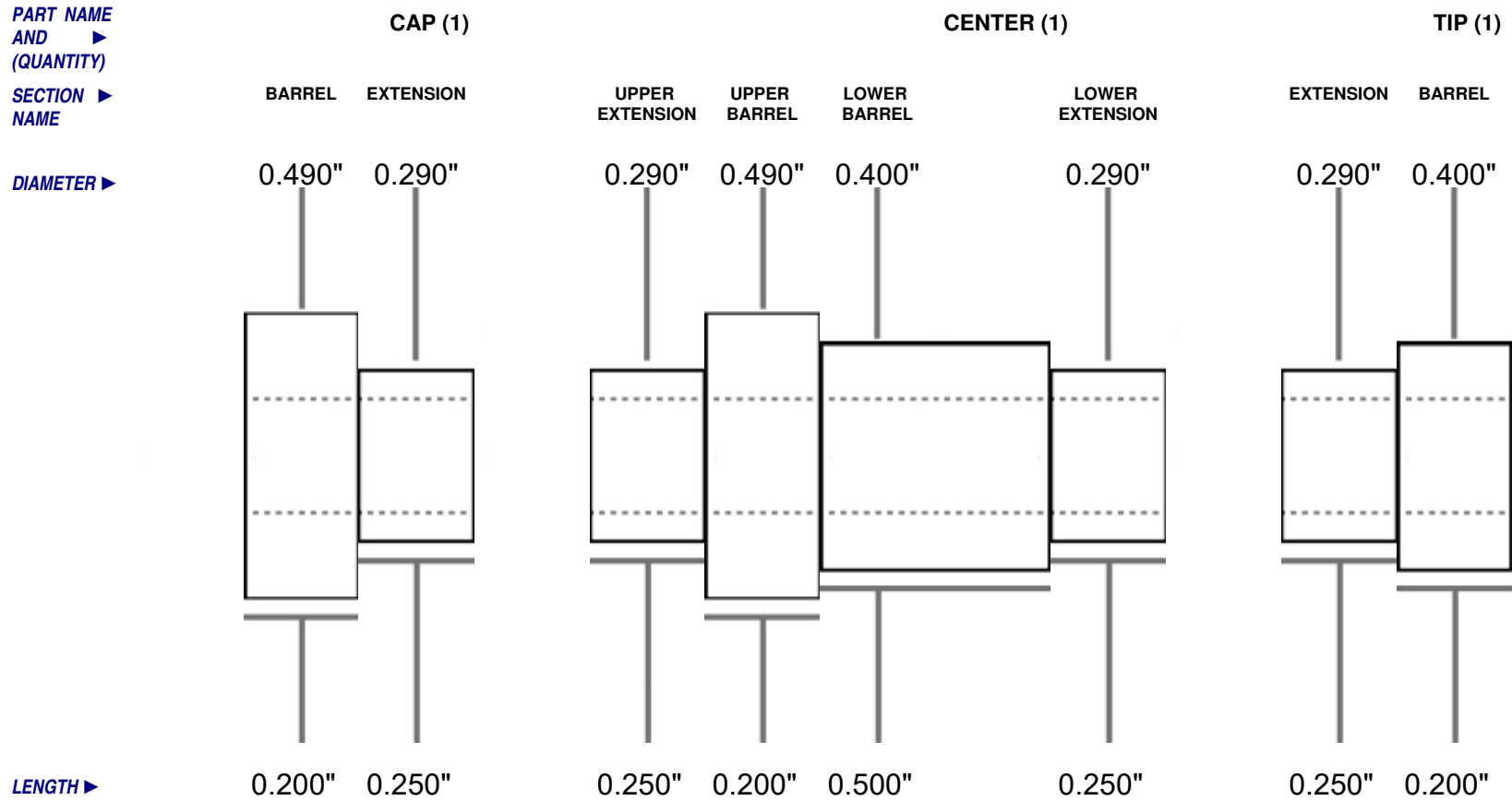

ASSOCIATED KITS: PKPARK-(XX), PKPARK-LO(XX)

PICTURE IS AN APPROXIMATE REPRESENTATION. NOT TO EXACT SCALE OR PROPORTION. ALL MEASUREMENTS IN INCHES. BUSHING DIAMETERS (TOP ROW) ARE OPTIMAL AND SHOULD VARY BY NO MORE THAN .002" WHEN NEW.

ID NUMBER PKPATDSBU **TYPE:** BUSHING

NOTES:

NUMBER OF PARTS 3

THRU HOLE STANDARD (0.248')

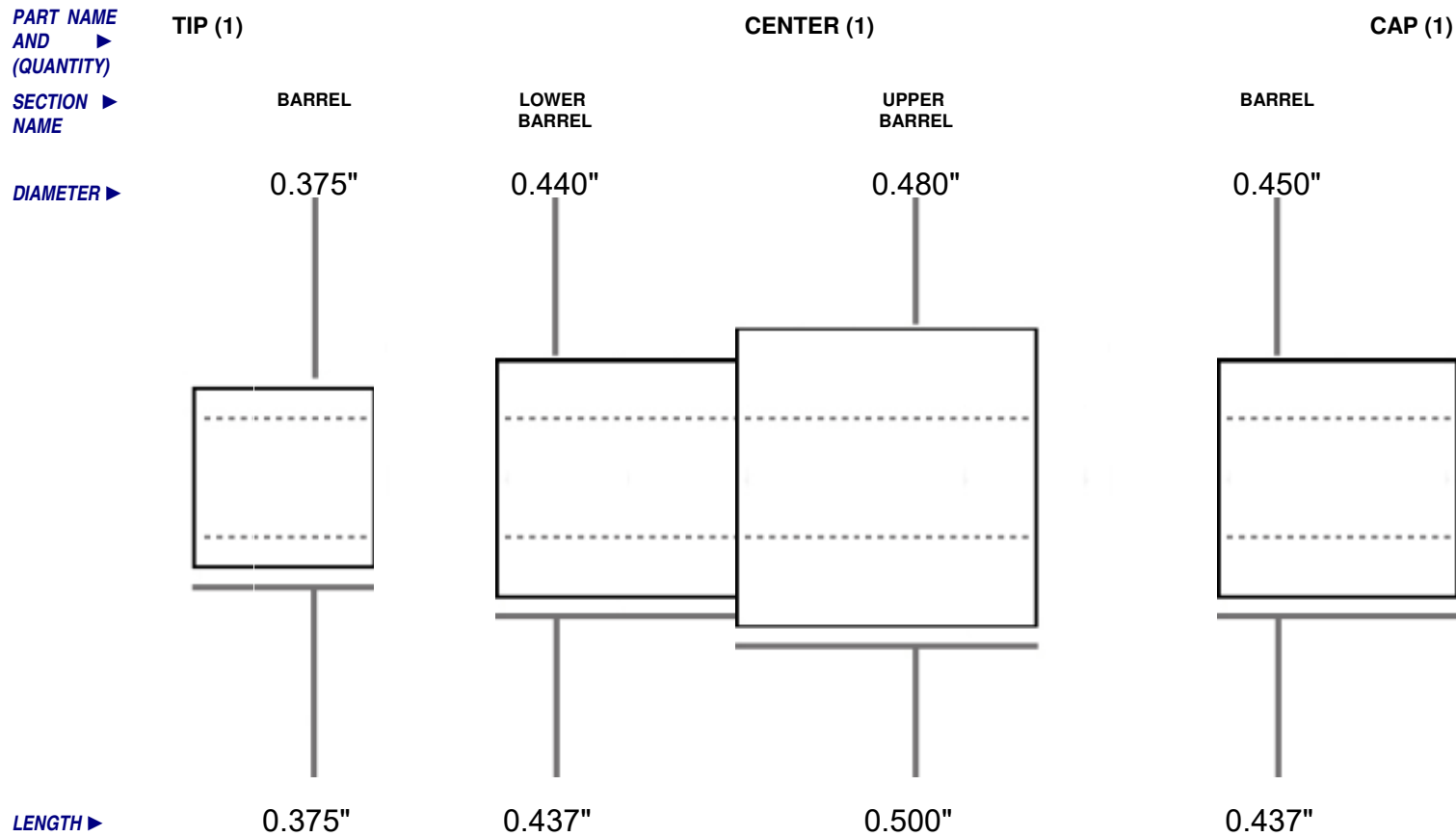

ASSOCIATED PKPATDS(XX)
KITS:

PICTURE IS AN APPROXIMATE REPRESENTATION. NOT TO EXACT SCALE OR PROPORTION. ALL MEASUREMENTS IN INCHES. BUSHING DIAMETERS (TOP ROW) ARE OPTIMAL AND SHOULD VARY BY NO MORE THAN .002" WHEN NEW.

ID NUMBER PKPATPENBU **TYPE:** BUSHING

NOTES:

NUMBER OF PARTS 3

THRU HOLE STANDARD(0.248")

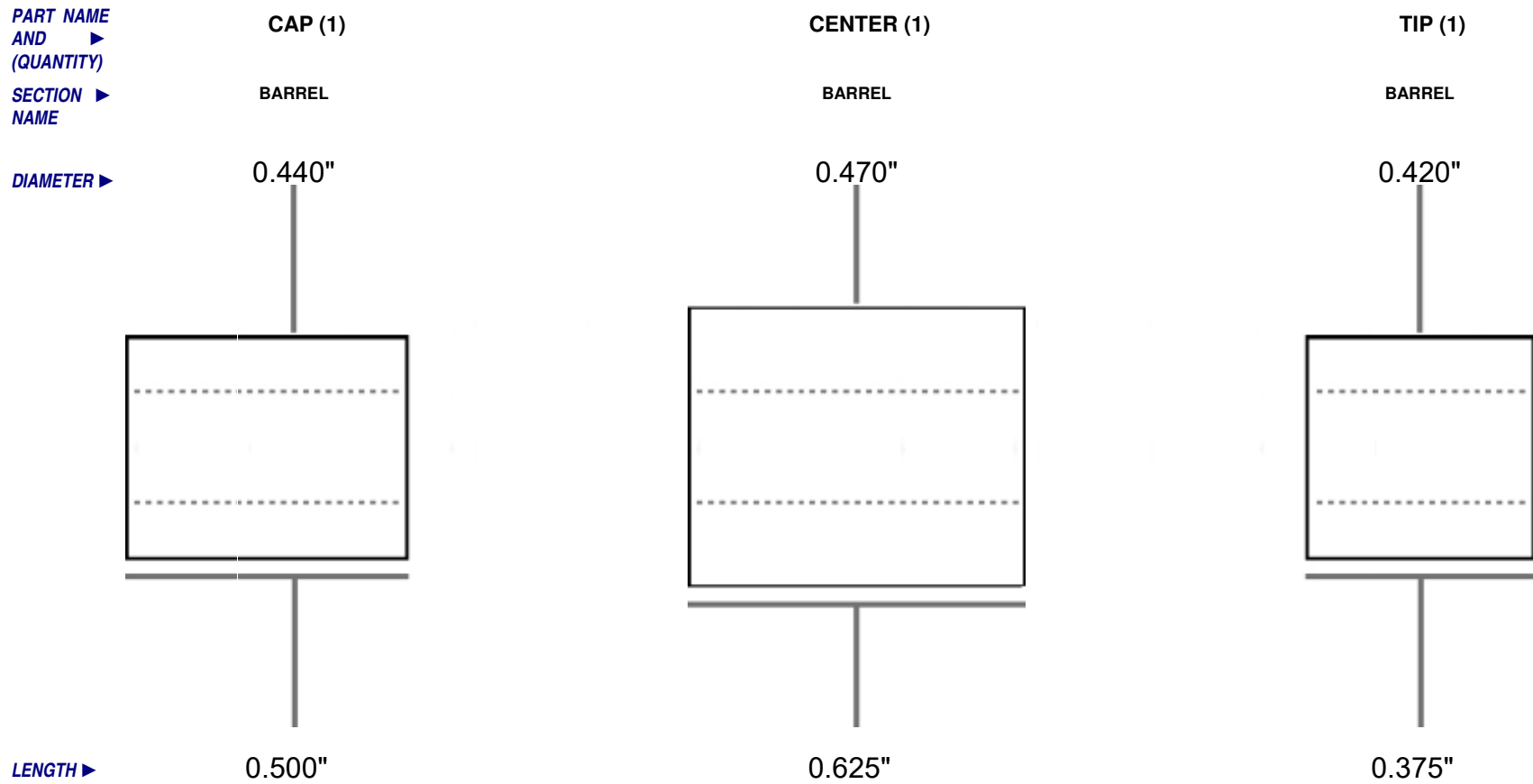

ASSOCIATED PKPATPCL(XX), PKPATPEN(XX)
KITS:

PICTURE IS AN APPROXIMATE REPRESENTATION. NOT TO EXACT SCALE OR PROPORTION. ALL MEASUREMENTS IN INCHES. BUSHING DIAMETERS (TOP ROW) ARE OPTIMAL AND SHOULD VARY BY NO MORE THAN .002" WHEN NEW.

ID NUMBER PKPCUBU **TYPE:** BUSHING
NUMBER OF PARTS 4
THRU HOLE STANDARD (0.248')

NOTES: EACH BARREL TURNED SEPARATELY DUE TO LENGTH OF TUBES. SLEEVE GOES OVER CAP BUSHING AGAINST BLANK FOR FIRST STEP AND SLIDES AWAY FROM BLANK FOR SECOND STEP. SLEEVE HAS A SET SCREW TO KEEP IT IN PLACE.

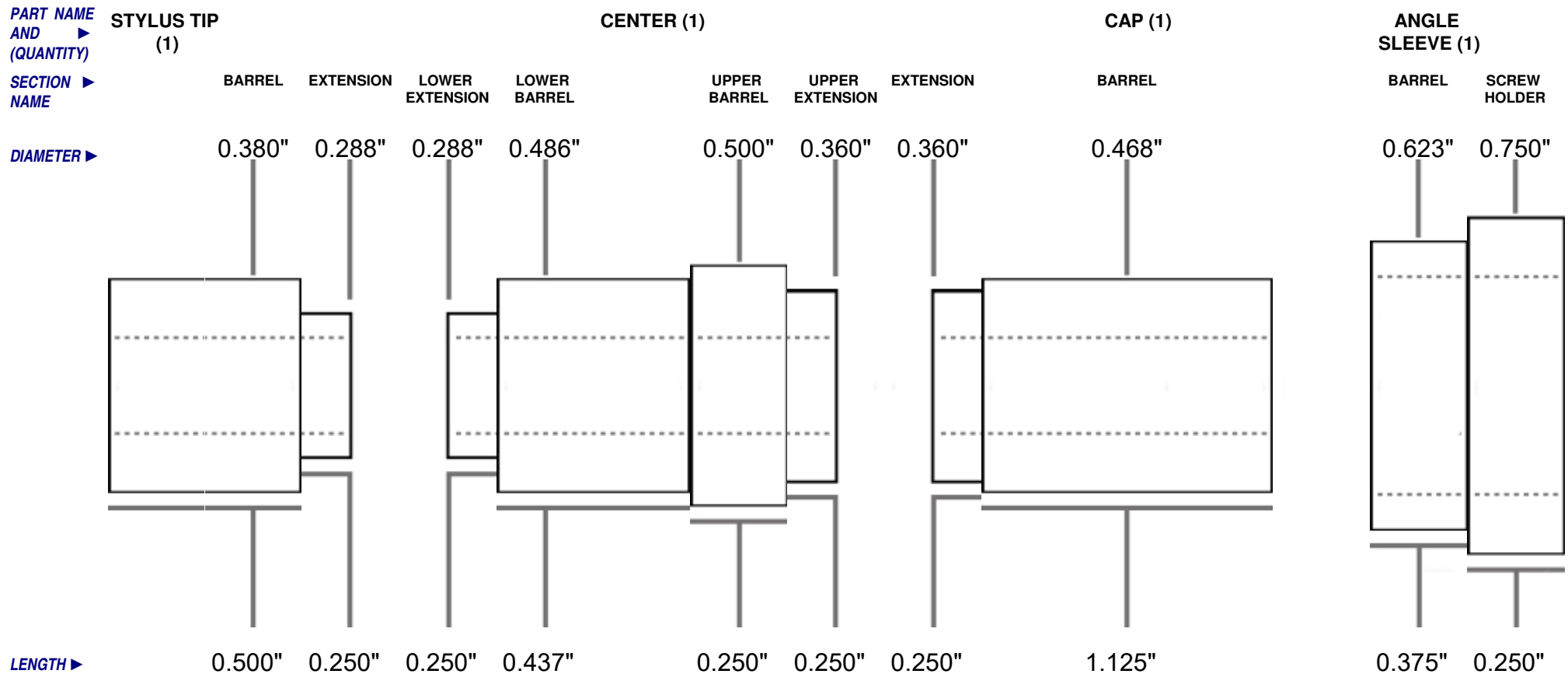

ASSOCIATED PKPCU(XX)
KITS:

PICTURE IS AN APPROXIMATE REPRESENTATION. NOT TO EXACT SCALE OR PROPORTION. ALL MEASUREMENTS IN INCHES. BUSHING DIAMETERS (TOP ROW) ARE OPTIMAL AND SHOULD VARY BY NO MORE THAN .002" WHEN NEW.

ID NUMBER PK-PENXXBU **TYPE:** BUSHING

NOTES: TIP AND CAP ARE IDENTICAL

NUMBER OF PARTS 3

THRU HOLE STANDARD(0.248")

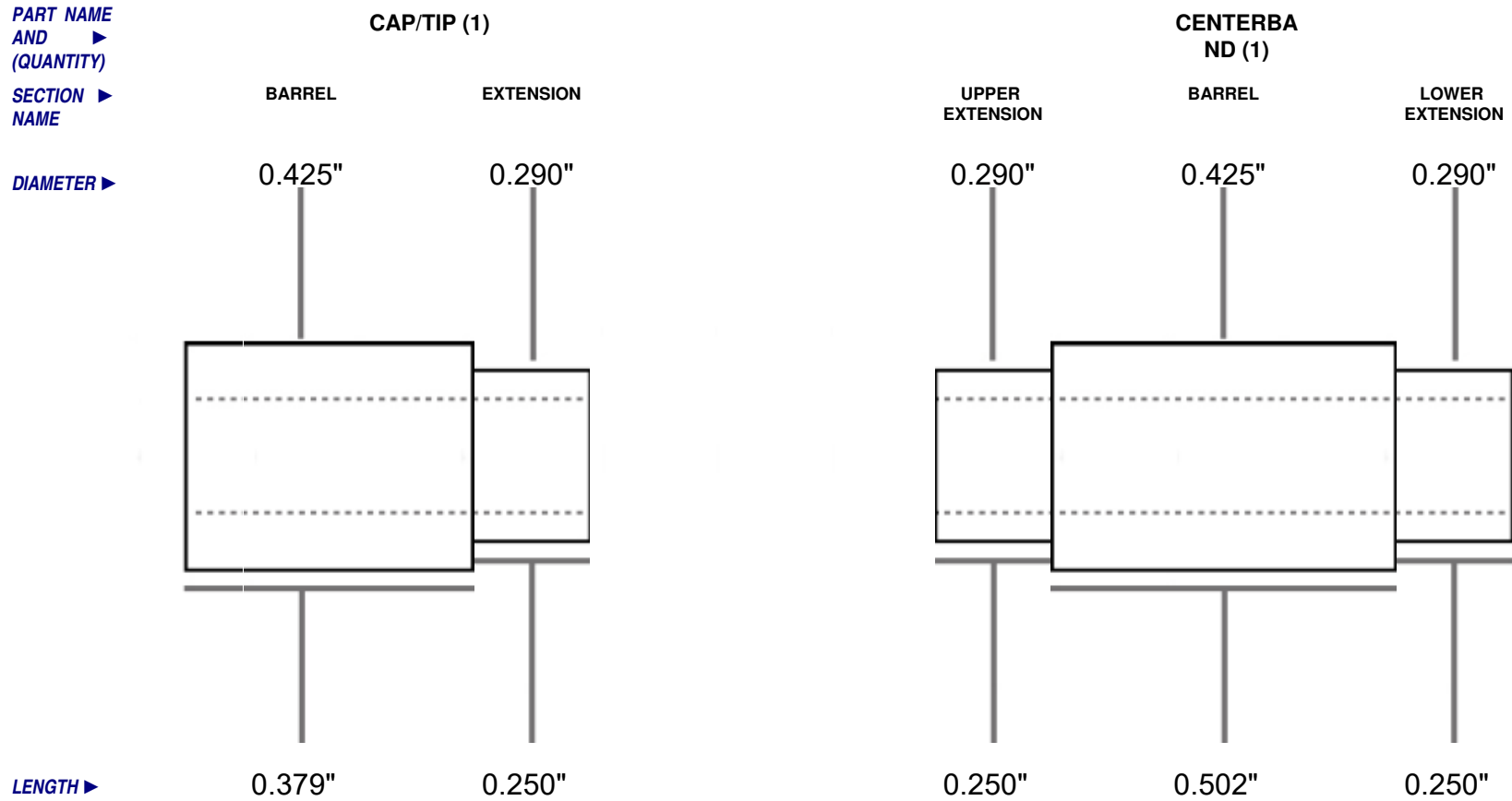

ASSOCIATED PK-PCLXX(XX), PK-PENXX(XX)

KITS:

PICTURE IS AN APPROXIMATE REPRESENTATION. NOT TO EXACT SCALE OR PROPORTION. ALL MEASUREMENTS IN INCHES. BUSHING DIAMETERS (TOP ROW) ARE OPTIMAL AND SHOULD VARY BY NO MORE THAN .002" WHEN NEW.

ID NUMBER PKPERF-BU **TYPE:** BUSHING

NOTES: CAP/END ARE SAME DIMENSION

NUMBER OF PARTS 3

THRU HOLE STANDARD(0.248")

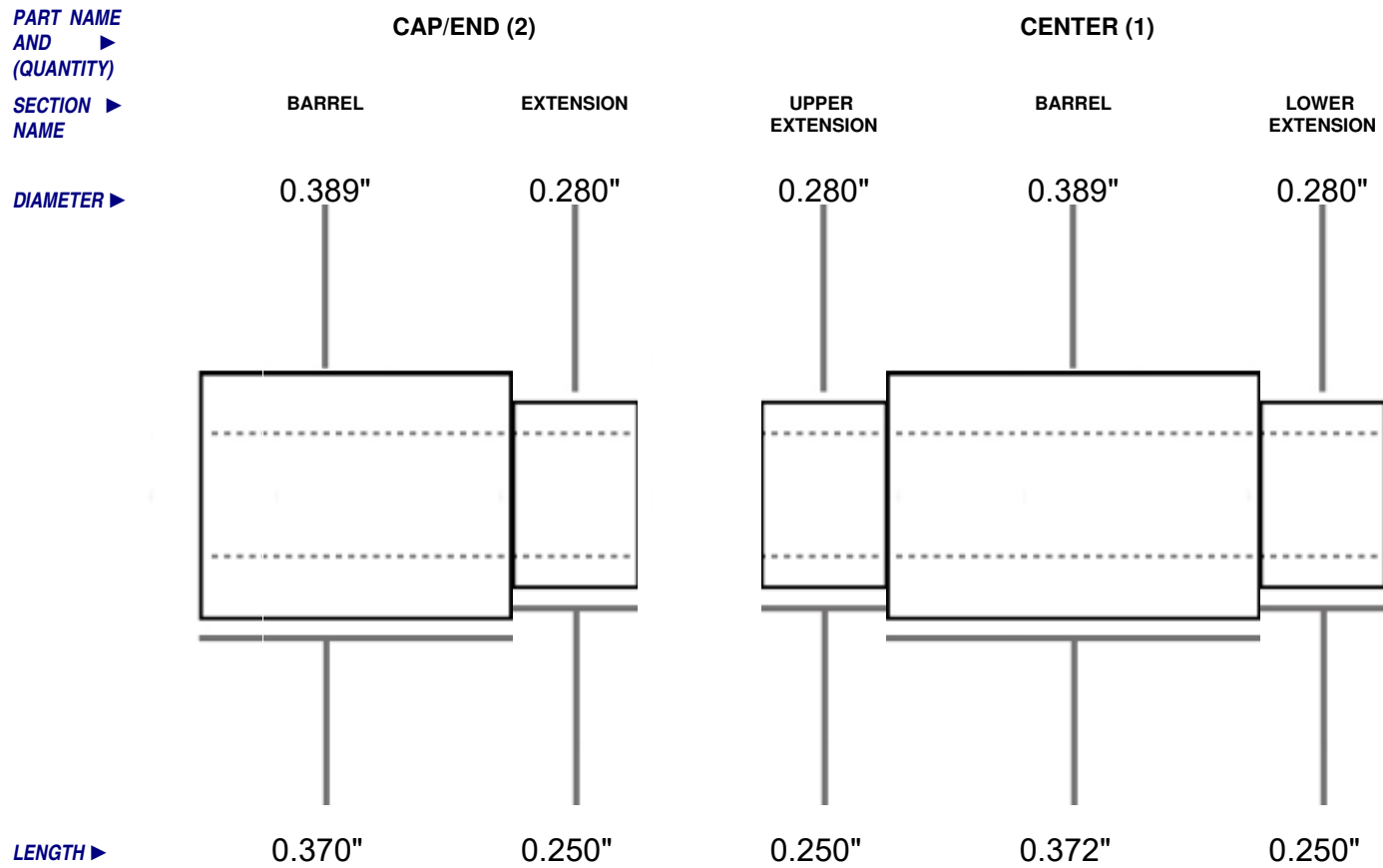

ASSOCIATED PKPERF(XX)
KITS:

PICTURE IS AN APPROXIMATE REPRESENTATION. NOT TO EXACT SCALE OR PROPORTION. ALL MEASUREMENTS IN INCHES. BUSHING DIAMETERS (TOP ROW) ARE OPTIMAL AND SHOULD VARY BY NO MORE THAN .002" WHEN NEW.

ID NUMBER PKPHANGM **TYPE:** DRILL CHUCK MANDREL

NOTES: FITS IN HEADSTOCK MOUNTED DRILL CHUCK

NUMBER OF PARTS 1

THRU HOLE NONE.

PART NAME AND (QUANTITY)

SECTION NAME

DIAMETER

LENGTH

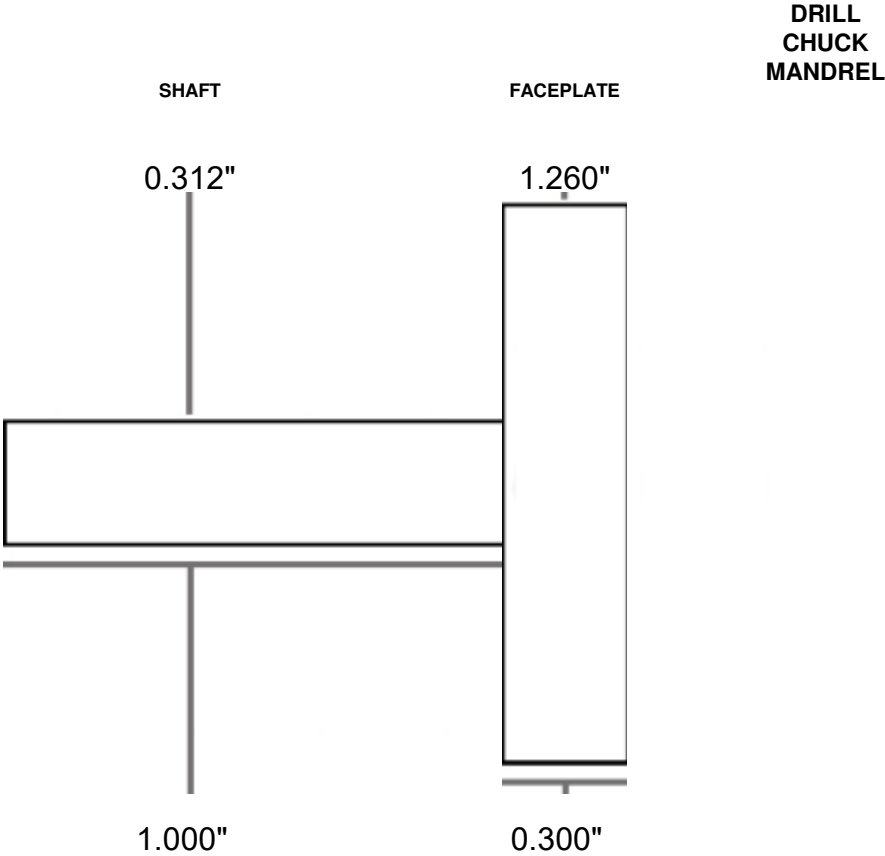

ASSOCIATED PKPHANG(XX)
KITS:

PICTURE IS AN APPROXIMATE REPRESENTATION. NOT TO EXACT SCALE OR PROPORTION. ALL MEASUREMENTS IN INCHES. BUSHING DIAMETERS (TOP ROW) ARE OPTIMAL AND SHOULD VARY BY NO MORE THAN .002" WHEN NEW.

ID NUMBER PKPIRBU

TYPE: BUSHING

NOTES: BOTH ENDS SAME DIMENSIONS

NUMBER OF PARTS 3

THRU HOLE STANDARD (0.248')

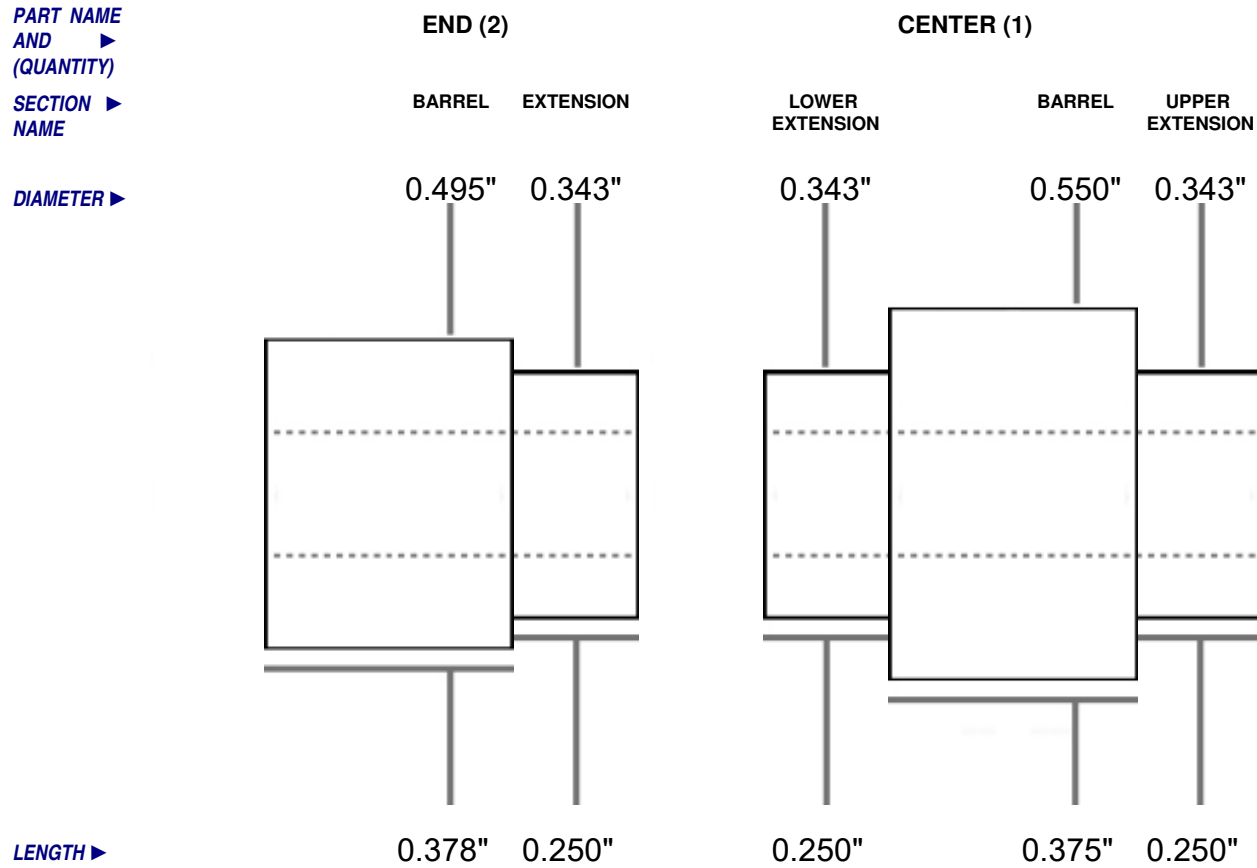

ASSOCIATED PKPIR(XX)

KITS:

PICTURE IS AN APPROXIMATE REPRESENTATION. NOT TO EXACT SCALE OR PROPORTION. ALL MEASUREMENTS IN INCHES. BUSHING DIAMETERS (TOP ROW) ARE OPTIMAL AND SHOULD VARY BY NO MORE THAN .002" WHEN NEW.

ID NUMBER PKPLI2-BU

TYPE: BUSHING

NOTES: BOTH BUSHINGS SAME DIMENSION

NUMBER OF PARTS 2

THRU HOLE STANDARD (0.248')

PART NAME AND (QUANTITY)

SECTION NAME

DIAMETER

LENGTH

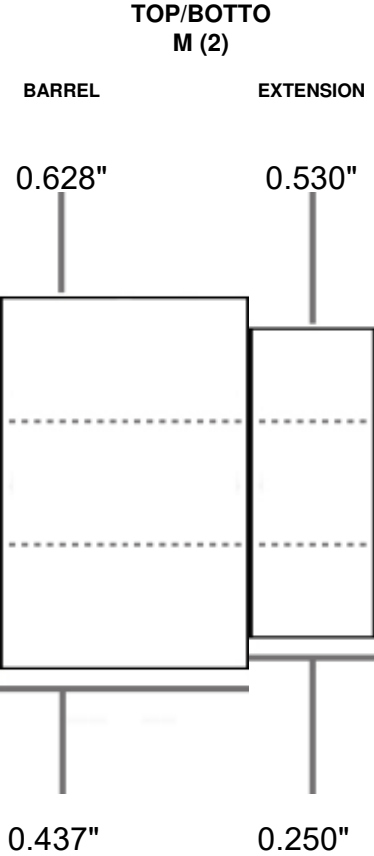

ASSOCIATED PKPLI2(XX)
KITS:

PICTURE IS AN APPROXIMATE REPRESENTATION. NOT TO EXACT SCALE OR PROPORTION. ALL MEASUREMENTS IN INCHES. BUSHING DIAMETERS (TOP ROW) ARE OPTIMAL AND SHOULD VARY BY NO MORE THAN .002" WHEN NEW.

ID NUMBER PKPLI-BU

TYPE: BUSHING

NOTES: CAP AND TIP SAME DIMENSIONS

NUMBER OF PARTS 3

THRU HOLE STANDARD (0.248')

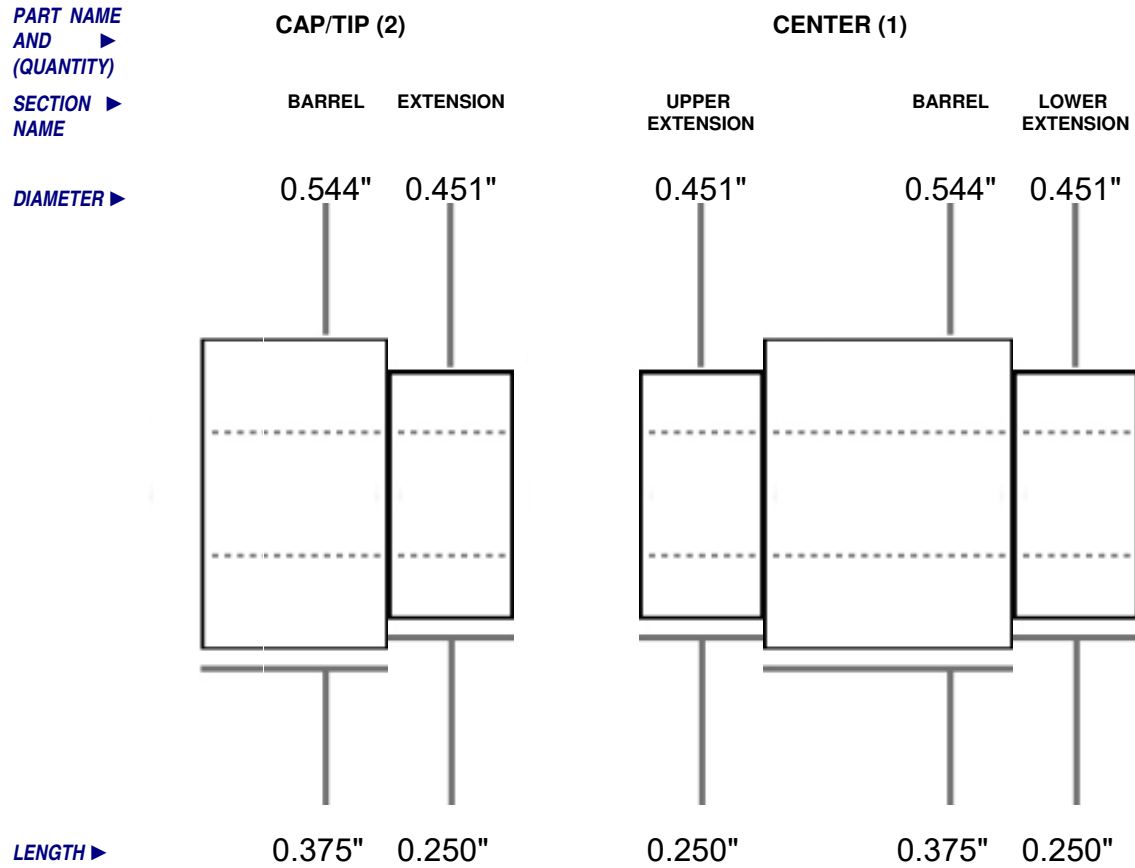

ASSOCIATED PKPLI3(XX), PKPLIX(XX)

KITS:

PICTURE IS AN APPROXIMATE REPRESENTATION. NOT TO EXACT SCALE OR PROPORTION. ALL MEASUREMENTS IN INCHES. BUSHING DIAMETERS (TOP ROW) ARE OPTIMAL AND SHOULD VARY BY NO MORE THAN .002" WHEN NEW.

ID NUMBER PK-POLBU

TYPE: BUSHING

NOTES:

NUMBER OF PARTS 2

THRU HOLE STANDARD(0.248")

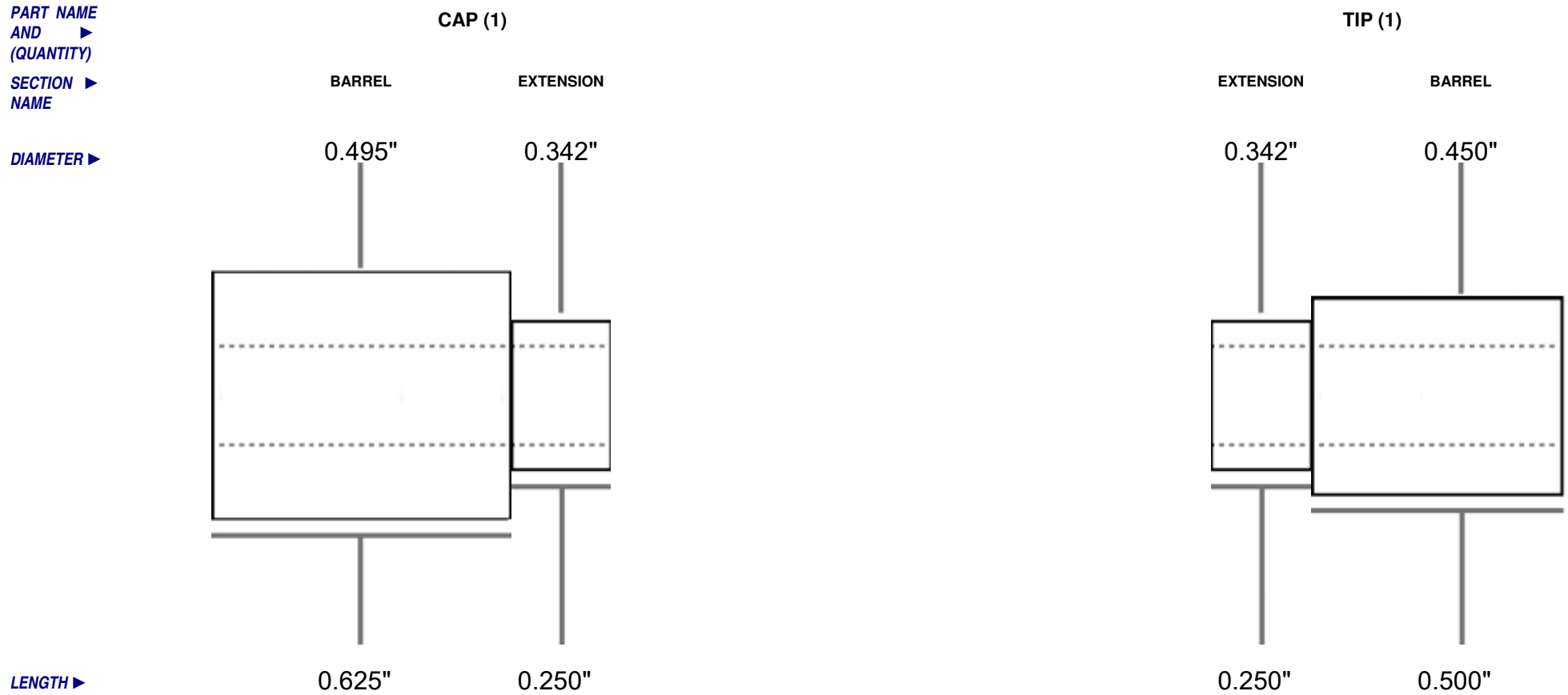

ASSOCIATED PKPOLPCL(XX), PKPOLPEN(XX)

KITS:

PICTURE IS AN APPROXIMATE REPRESENTATION. NOT TO EXACT SCALE OR PROPORTION. ALL MEASUREMENTS IN INCHES. BUSHING DIAMETERS (TOP ROW) ARE OPTIMAL AND SHOULD VARY BY NO MORE THAN .002" WHEN NEW.

ID NUMBER PKPOLICEBU **TYPE:** BUSHING

NOTES:

NUMBER OF PARTS 2

THRU HOLE STANDARD (0.248')

PART NAME AND (QUANTITY)

SECTION NAME

DIAMETER

LENGTH

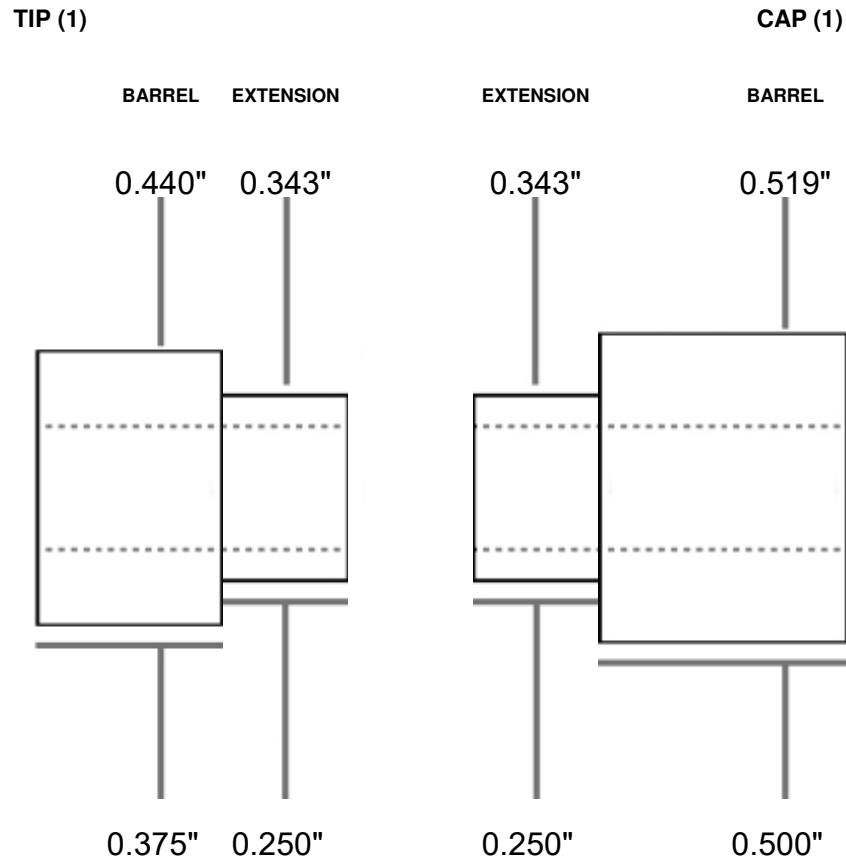

ASSOCIATED PKPOLICE(XX)

KITS:

PICTURE IS AN APPROXIMATE REPRESENTATION. NOT TO EXACT SCALE OR PROPORTION. ALL MEASUREMENTS IN INCHES. BUSHING DIAMETERS (TOP ROW) ARE OPTIMAL AND SHOULD VARY BY NO MORE THAN .002" WHEN NEW.

ID NUMBER PKPOWBU

TYPE: BUSHING

NOTES:

NUMBER OF PARTS 3

THRU HOLE STANDARD(0.248")

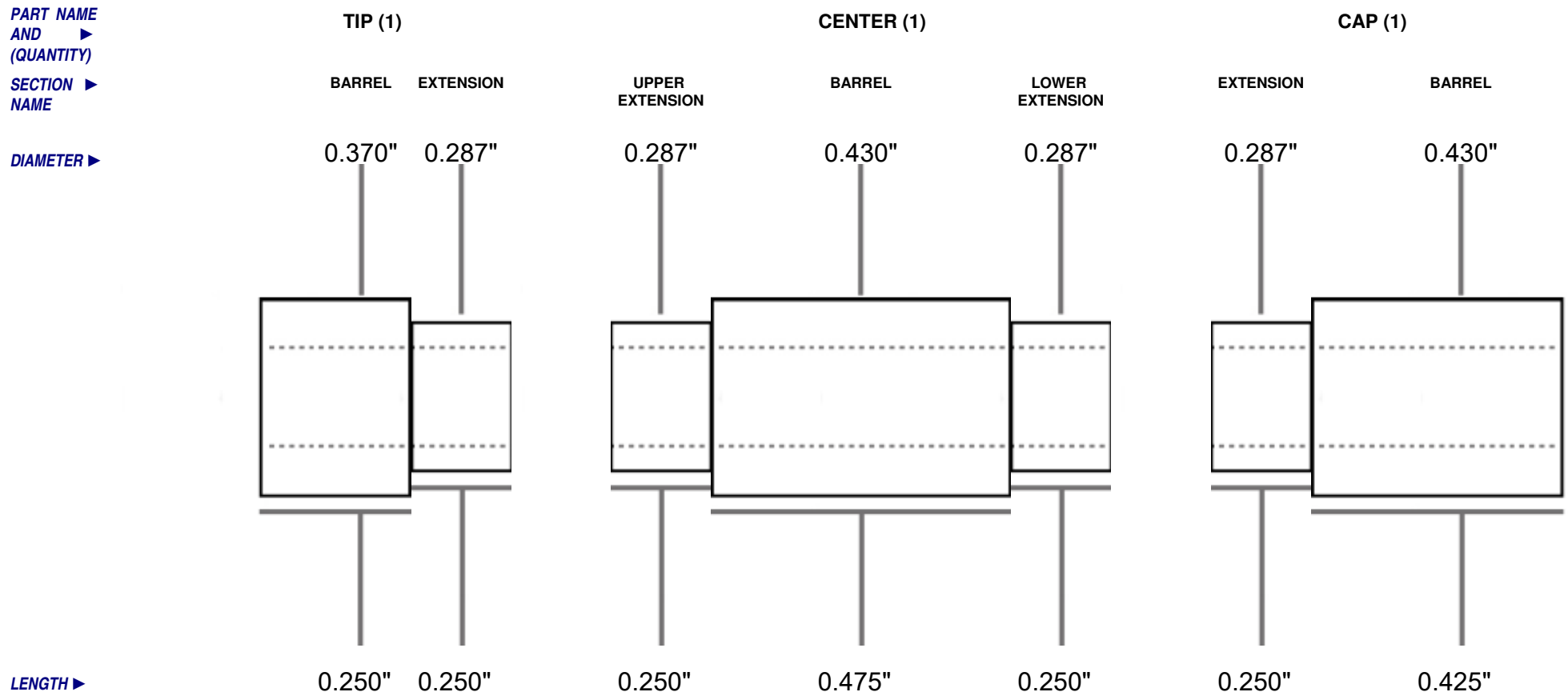

ASSOCIATED PKPOWPCL(XX), PKPOWPEN(XX)
KITS:

PICTURE IS AN APPROXIMATE REPRESENTATION. NOT TO EXACT SCALE OR PROPORTION. ALL MEASUREMENTS IN INCHES. BUSHING DIAMETERS (TOP ROW) ARE OPTIMAL AND SHOULD VARY BY NO MORE THAN .002" WHEN NEW.

ID NUMBER PKPPENBU **TYPE:** BUSHING

NOTES: TIP AND CAP HAVE SAME DIMENSION

NUMBER OF PARTS 3

THRU HOLE STANDARD(0.248")

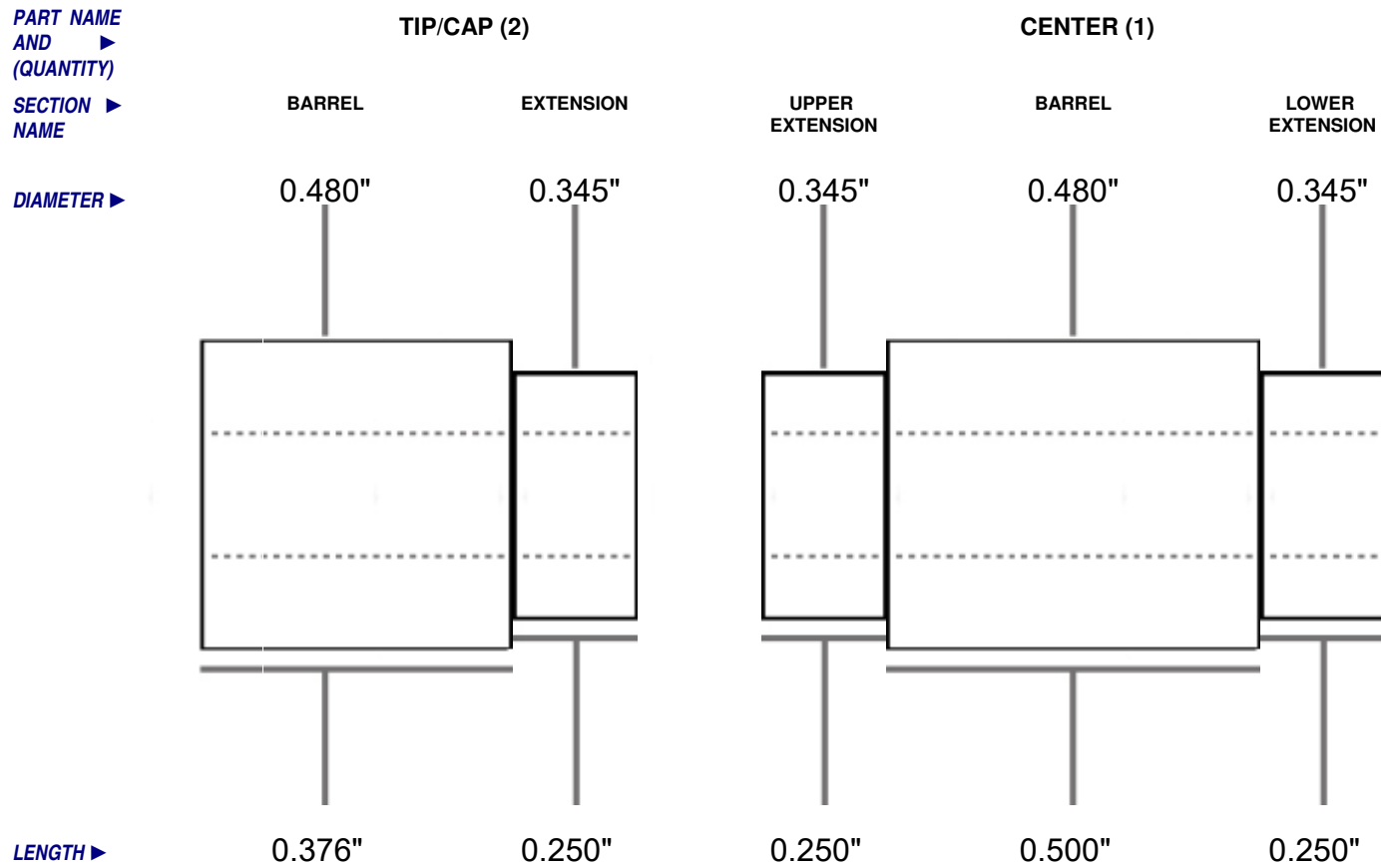

ASSOCIATED PKFLY(XX), PKPPEN(XX)
KITS:

PICTURE IS AN APPROXIMATE REPRESENTATION. NOT TO EXACT SCALE OR PROPORTION. ALL MEASUREMENTS IN INCHES. BUSHING DIAMETERS (TOP ROW) ARE OPTIMAL AND SHOULD VARY BY NO MORE THAN .002" WHEN NEW.

ID NUMBER PKPPRBBU

TYPE: BUSHING

NOTES:

NUMBER OF PARTS 3

THRU HOLE STANDARD(0.248")

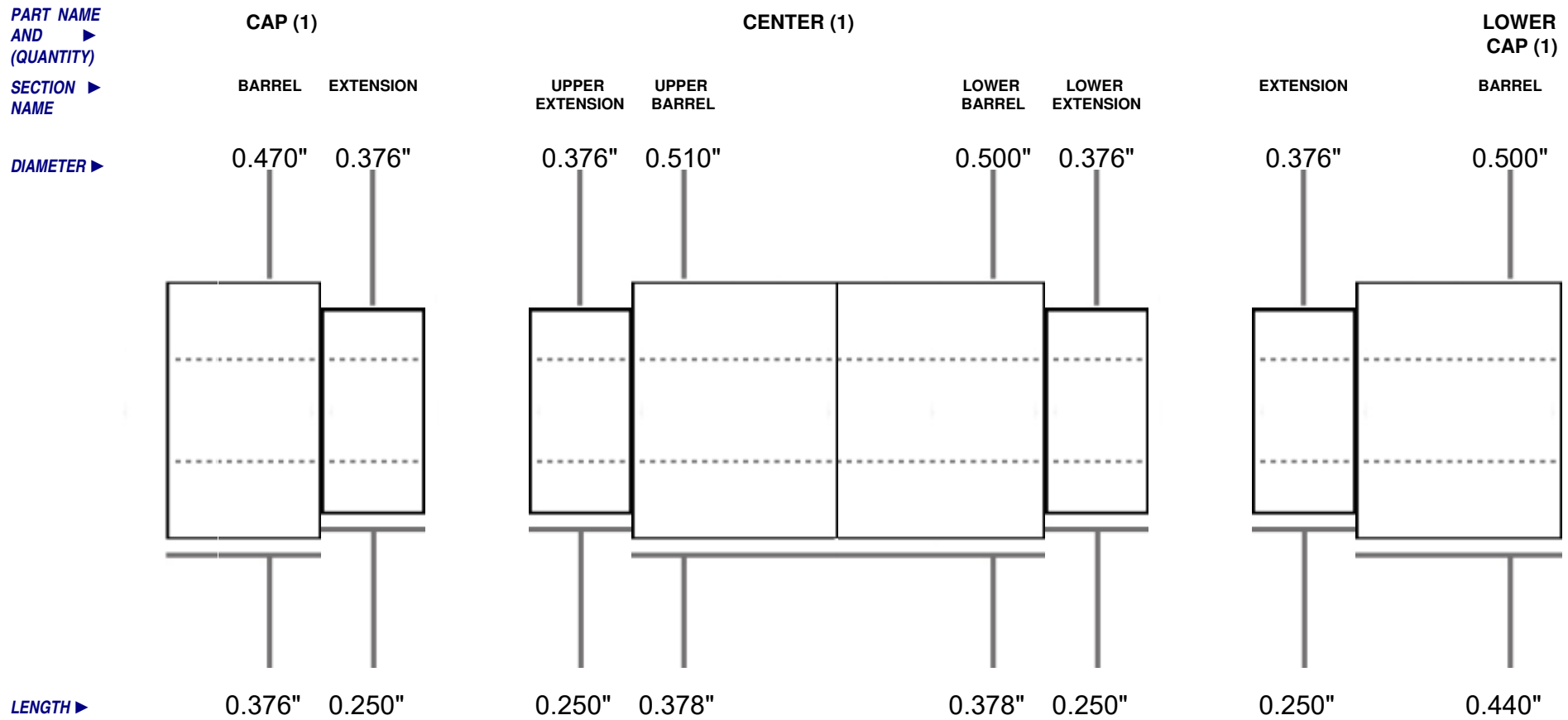

ASSOCIATED PKPPFP(XX), PKPPRB(XX)

KITS:

PICTURE IS AN APPROXIMATE REPRESENTATION. NOT TO EXACT SCALE OR PROPORTION. ALL MEASUREMENTS IN INCHES. BUSHING DIAMETERS (TOP ROW) ARE OPTIMAL AND SHOULD VARY BY NO MORE THAN .002" WHEN NEW.

ID NUMBER PKPRPENBU **TYPE:** BUSHING

NOTES:

NUMBER OF PARTS 3

THRU HOLE STANDARD(0.248")

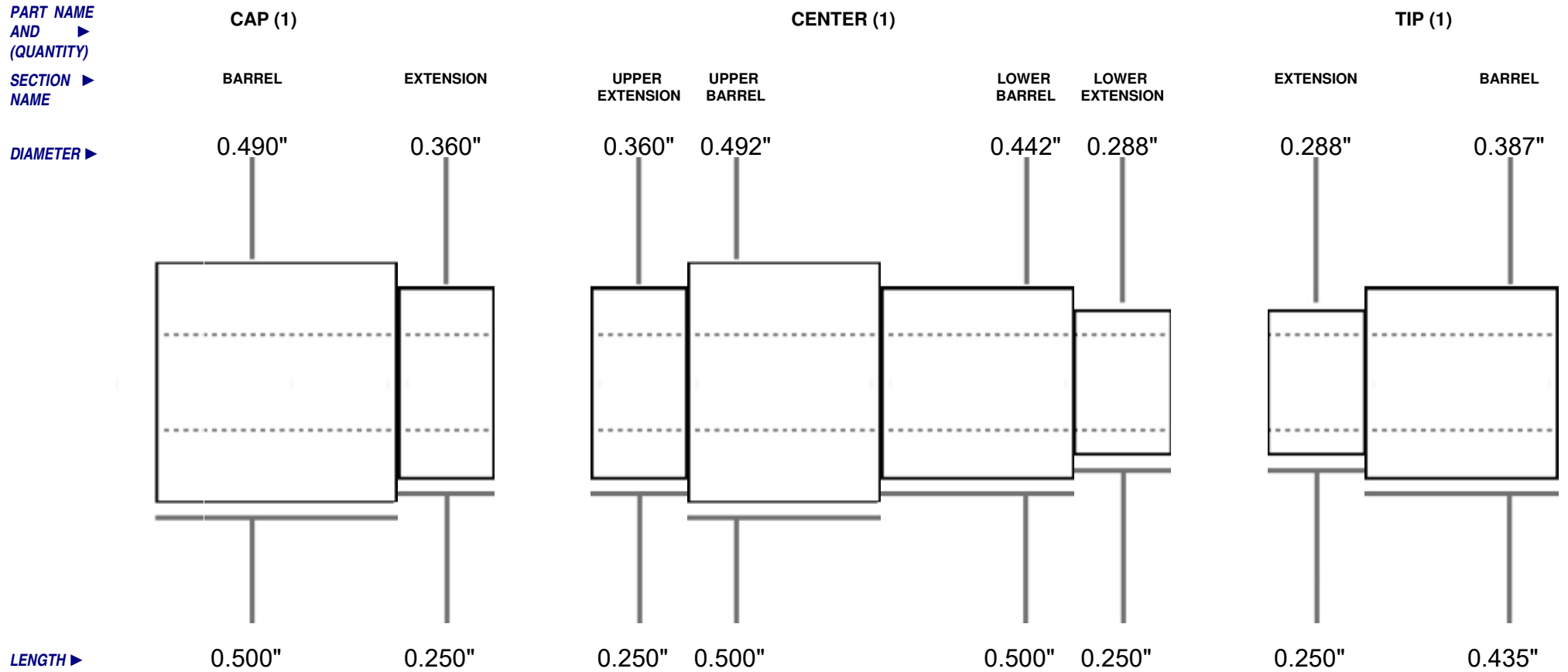

ASSOCIATED PKPRPEN(XX)

KITS:

PICTURE IS AN APPROXIMATE REPRESENTATION. NOT TO EXACT SCALE OR PROPORTION. ALL MEASUREMENTS IN INCHES. BUSHING DIAMETERS (TOP ROW) ARE OPTIMAL AND SHOULD VARY BY NO MORE THAN .002" WHEN NEW.

ID NUMBER PKPT100BU **TYPE:** BUSHING

NOTES: TIP/CAP BUSHINGS HAVE SAME DIMENSION. ORIGINAL EXTENSION WAS .353", UPDATED TO .360" IN 10/2018.

NUMBER OF PARTS 2

THRU HOLE STANDARD(0.248")

PART NAME AND (QUANTITY)

SECTION NAME

DIAMETER

LENGTH

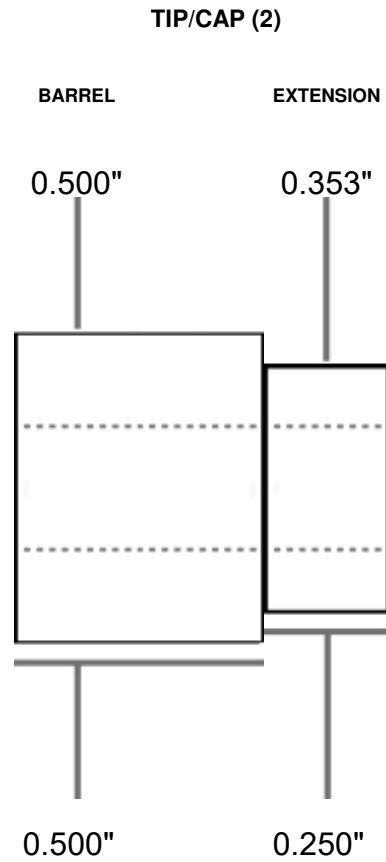

ASSOCIATED KITS: PKMOT(XX), PKPT100F(XX), PKPT100R(XX)

PICTURE IS AN APPROXIMATE REPRESENTATION. NOT TO EXACT SCALE OR PROPORTION. ALL MEASUREMENTS IN INCHES. BUSHING DIAMETERS (TOP ROW) ARE OPTIMAL AND SHOULD VARY BY NO MORE THAN .002" WHEN NEW.

ID NUMBER PKPURSEBU **TYPE:** BUSHING

NOTES:

NUMBER OF PARTS 3

THRU HOLE STANDARD (0.248')

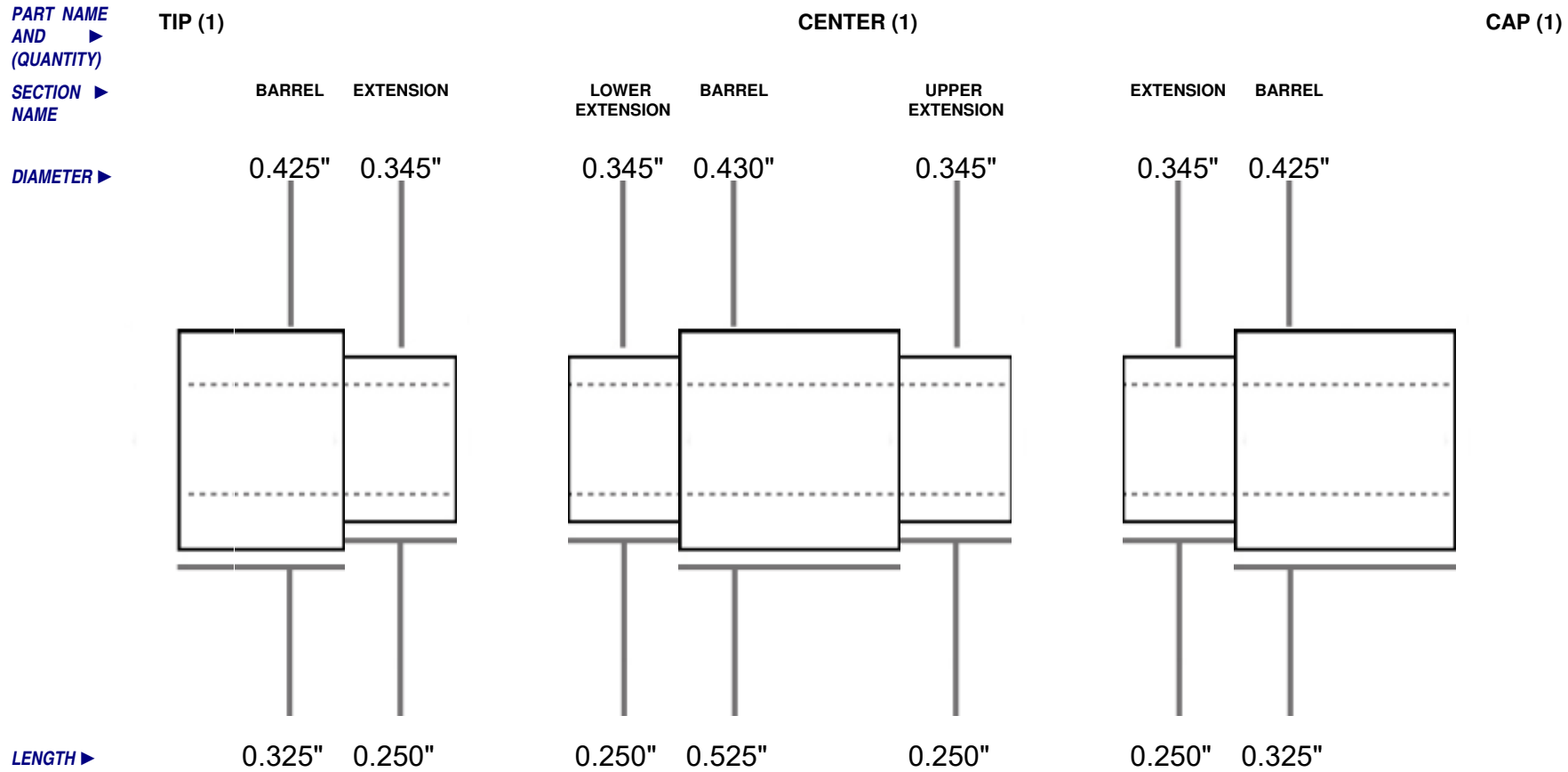

ASSOCIATED PKPURSE(XX)

KITS:

PICTURE IS AN APPROXIMATE REPRESENTATION. NOT TO EXACT SCALE OR PROPORTION. ALL MEASUREMENTS IN INCHES. BUSHING DIAMETERS (TOP ROW) ARE OPTIMAL AND SHOULD VARY BY NO MORE THAN .002" WHEN NEW.

ID NUMBER PKPUTBU

TYPE: BUSHING

NOTES: END BUSHINGS SAME DIAMETERS

NUMBER OF PARTS 3

THRU HOLE STANDARD (0.248')

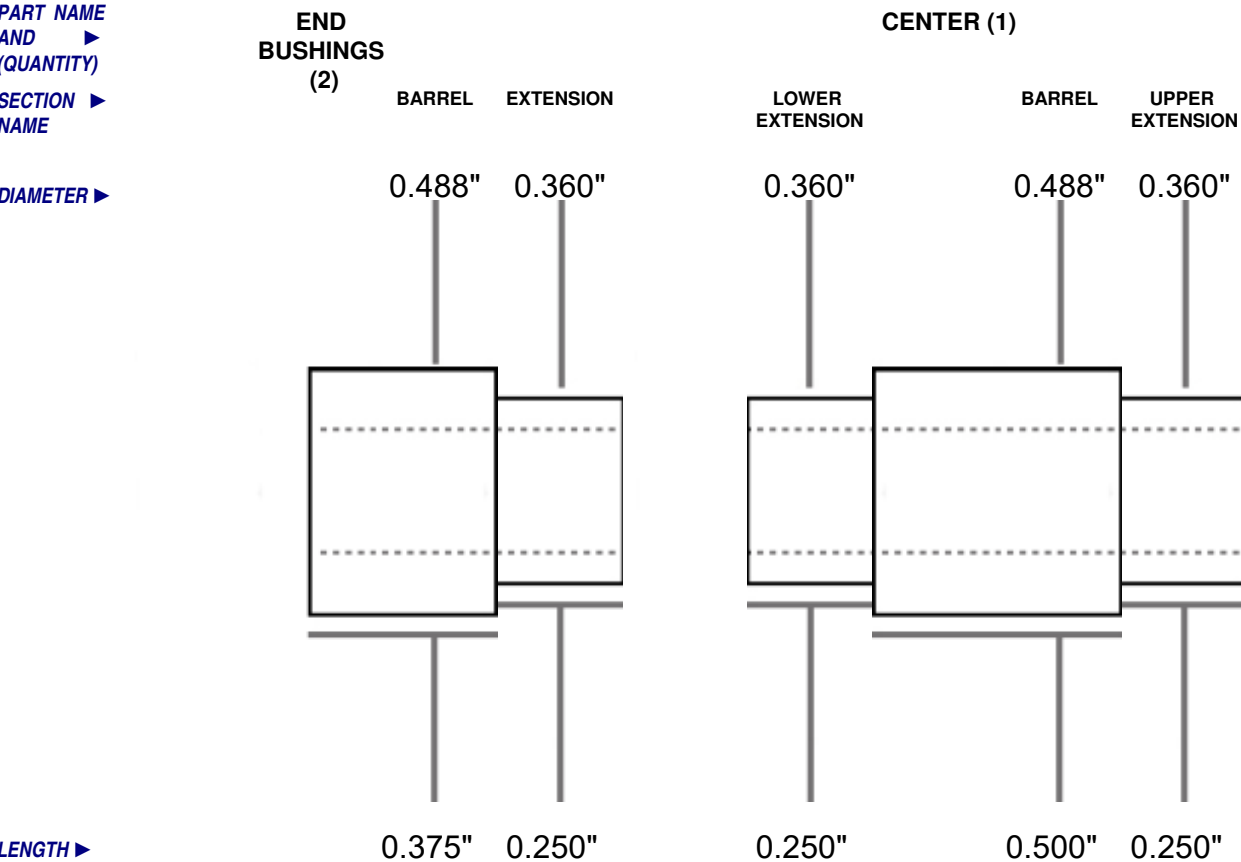

ASSOCIATED PKATHP(XX), PKPUTCH(XX)
KITS:

PICTURE IS AN APPROXIMATE REPRESENTATION. NOT TO EXACT SCALE OR PROPORTION. ALL MEASUREMENTS IN INCHES. BUSHING DIAMETERS (TOP ROW) ARE OPTIMAL AND SHOULD VARY BY NO MORE THAN .002" WHEN NEW.

ID NUMBER PKRAHANBU **TYPE:** BUSHING

NOTES: BOTH SIDES HAVE SAME DIMENSIONS

NUMBER OF PARTS 2

THRU HOLE STANDARD(0.248")

**PART NAME
AND** ▶
(QUANTITY)

SECTION ▶
NAME

DIAMETER ▶

CAP/TIP (2)

BARREL

0.400"

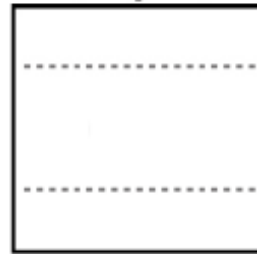

0.375"

LENGTH ▶

ASSOCIATED PKBPN(XX), PKRAHAN(XX), PKRAHANX(XX), PKRASAF(XX), PKTBHAN(XX)

KITS:

PICTURE IS AN APPROXIMATE REPRESENTATION. NOT TO EXACT SCALE OR PROPORTION. ALL MEASUREMENTS IN INCHES. BUSHING DIAMETERS (TOP ROW) ARE OPTIMAL AND SHOULD VARY BY NO MORE THAN .002" WHEN NEW.

ID NUMBER PKRASAF2BU **TYPE:** BUSHING

NOTES: BOTH ENDS SAME DIMENSIONS

NUMBER OF PARTS 2

THRU HOLE STANDARD (0.248')

PART NAME AND (QUANTITY)

SECTION NAME

DIAMETER

LENGTH

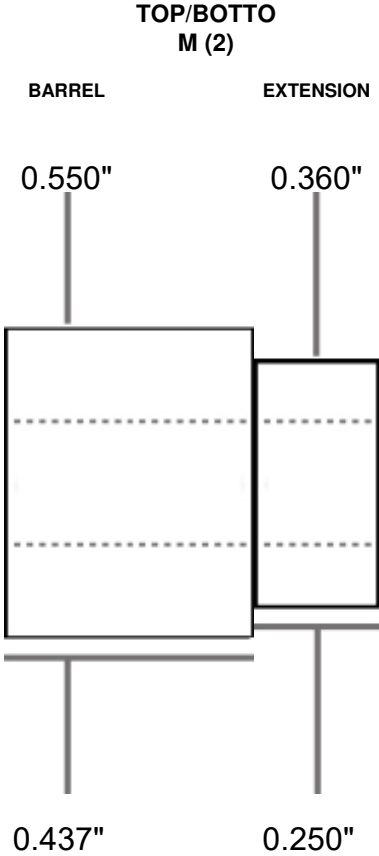

ASSOCIATED PKRASAF2(XX)
KITS:

PICTURE IS AN APPROXIMATE REPRESENTATION. NOT TO EXACT SCALE OR PROPORTION. ALL MEASUREMENTS IN INCHES. BUSHING DIAMETERS (TOP ROW) ARE OPTIMAL AND SHOULD VARY BY NO MORE THAN .002" WHEN NEW.

ID NUMBER PKRASTBU **TYPE:** BUSHING

NOTES: BOTH ENDS SAME DIMENSION

NUMBER OF PARTS 2

THRU HOLE STANDARD(0.248")

PART NAME AND (QUANTITY)

SECTION NAME

DIAMETER

END (2)

BARREL

0.530"



LENGTH

0.500"

ASSOCIATED KITS: PKRASTB(XX), PKRASTE(XX), PKRASTF(XX)

PICTURE IS AN APPROXIMATE REPRESENTATION. NOT TO EXACT SCALE OR PROPORTION. ALL MEASUREMENTS IN INCHES. BUSHING DIAMETERS (TOP ROW) ARE OPTIMAL AND SHOULD VARY BY NO MORE THAN .002" WHEN NEW.

ID NUMBER PKREVBV

TYPE: BUSHING

NOTES: BOTH SIDES SAME

NUMBER OF PARTS 2

THRU HOLE STANDARD (0.248')

PART NAME AND (QUANTITY)

SECTION NAME

DIAMETER

LENGTH

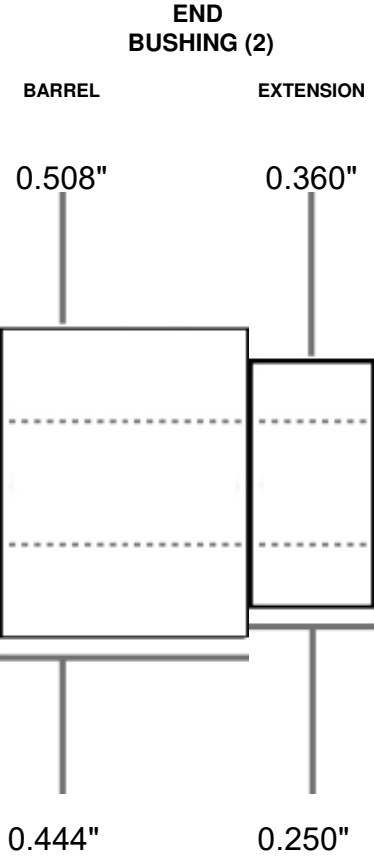

ASSOCIATED PKREV(XX)
KITS:

PICTURE IS AN APPROXIMATE REPRESENTATION. NOT TO EXACT SCALE OR PROPORTION. ALL MEASUREMENTS IN INCHES. BUSHING DIAMETERS (TOP ROW) ARE OPTIMAL AND SHOULD VARY BY NO MORE THAN .002" WHEN NEW.

ID NUMBER PKSANDPBU **TYPE:** BUSHING

NOTES: BOTH ENDS SAME DIMENSION

NUMBER OF PARTS 2

THRU HOLE STANDARD (0.248')

PART NAME AND (QUANTITY)

SECTION NAME

DIAMETER

LENGTH



ASSOCIATED KITS: PKSANDP(XX)

PICTURE IS AN APPROXIMATE REPRESENTATION. NOT TO EXACT SCALE OR PROPORTION. ALL MEASUREMENTS IN INCHES. BUSHING DIAMETERS (TOP ROW) ARE OPTIMAL AND SHOULD VARY BY NO MORE THAN .002" WHEN NEW.

ID NUMBER PKSAPENBU **TYPE:** BUSHING

NOTES:

NUMBER OF PARTS 2

THRU HOLE STANDARD(0.248")

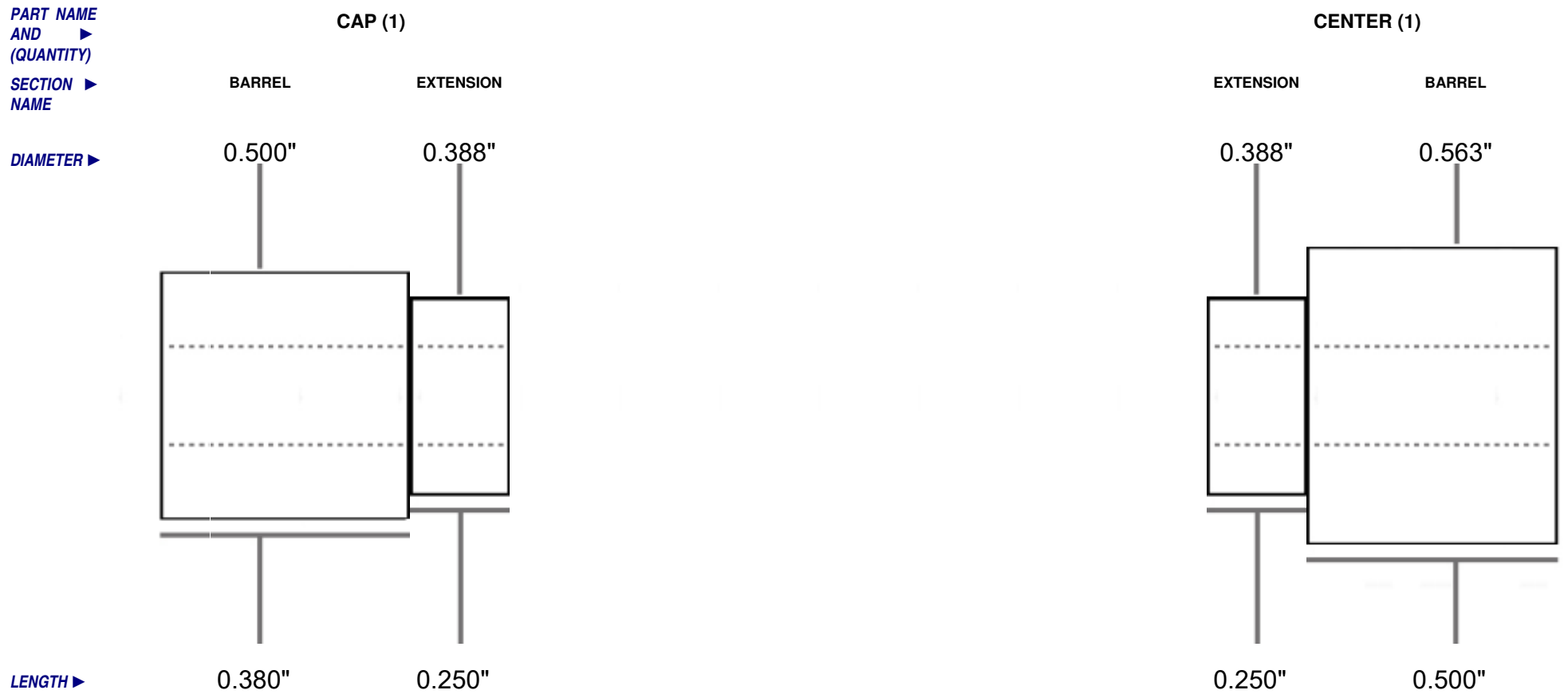

ASSOCIATED PKSAPEN(XX)
KITS:

PICTURE IS AN APPROXIMATE REPRESENTATION. NOT TO EXACT SCALE OR PROPORTION. ALL MEASUREMENTS IN INCHES. BUSHING DIAMETERS (TOP ROW) ARE OPTIMAL AND SHOULD VARY BY NO MORE THAN .002" WHEN NEW.

ID NUMBER PKSC-BU **TYPE:** BUSHING
NUMBER OF PARTS 3

NOTES: FOR LETTER OPENER, USE CAP AND WIDER PART OF CENTERBAND.

THRU HOLE STANDARD(0.248")

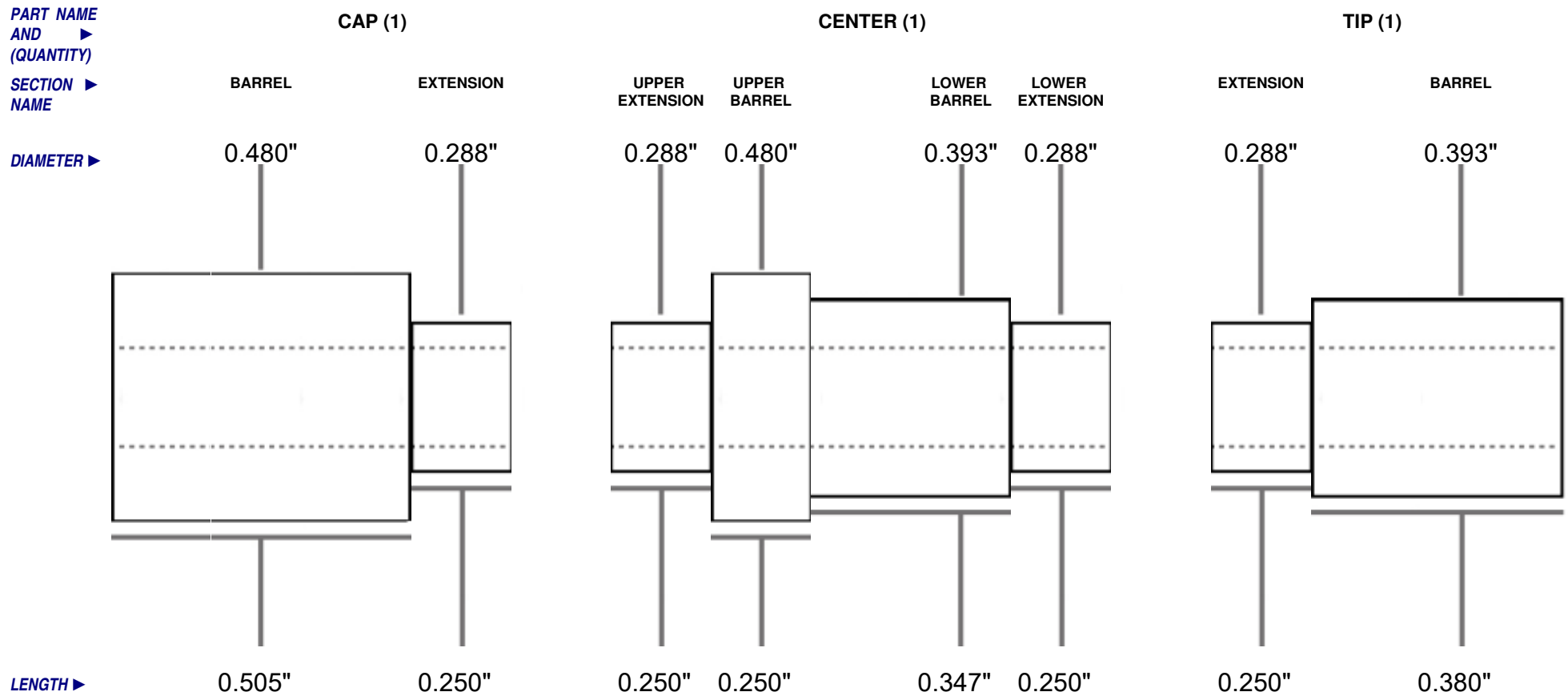

ASSOCIATED KITS: PKSC-LO(XX), PKSC-MAG(XX), PKSC-PEN(XX)V1, PKSC-PEN(XX)V2

PICTURE IS AN APPROXIMATE REPRESENTATION. NOT TO EXACT SCALE OR PROPORTION. ALL MEASUREMENTS IN INCHES. BUSHING DIAMETERS (TOP ROW) ARE OPTIMAL AND SHOULD VARY BY NO MORE THAN .002" WHEN NEW.

ID NUMBER PKSDPENBU **TYPE:** BUSHING

NOTES: CAP / CENTER BUSHINGS SAME DIAMETERS

NUMBER OF PARTS 3

THRU HOLE STANDARD (0.248')

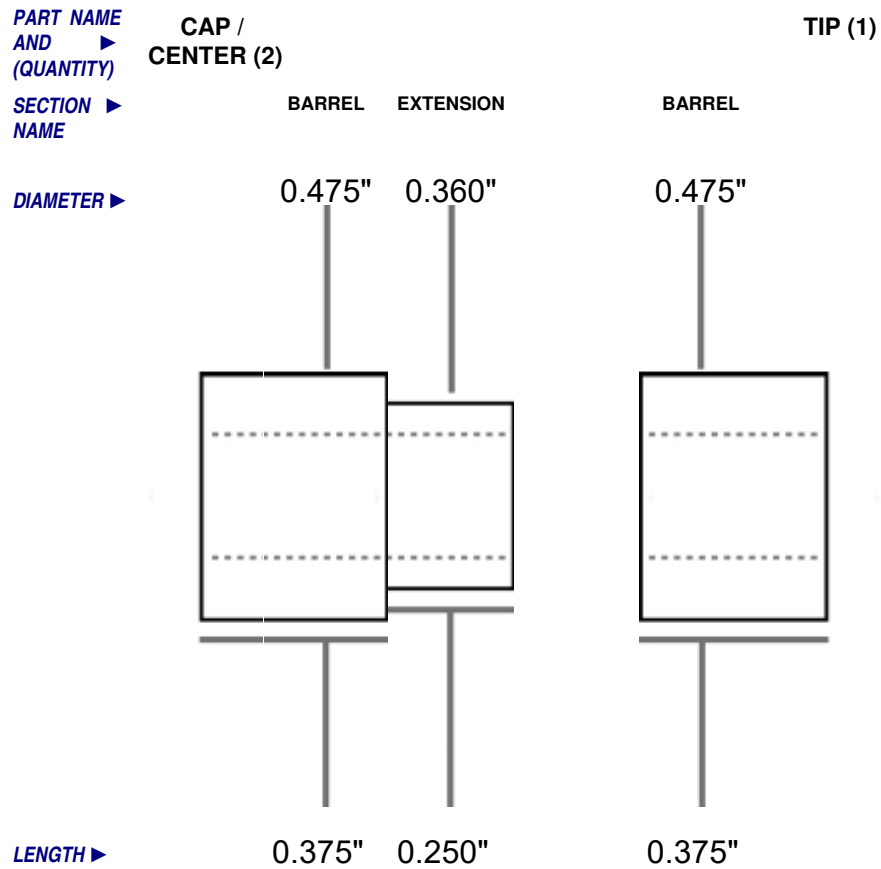

ASSOCIATED PKSDPEN(XX)
KITS:

PICTURE IS AN APPROXIMATE REPRESENTATION. NOT TO EXACT SCALE OR PROPORTION. ALL MEASUREMENTS IN INCHES. BUSHING DIAMETERS (TOP ROW) ARE OPTIMAL AND SHOULD VARY BY NO MORE THAN .002" WHEN NEW.

ID NUMBER PKSEGPENBU **TYPE:** BUSHING

NOTES:

NUMBER OF PARTS 4

THRU HOLE STANDARD (0.248')

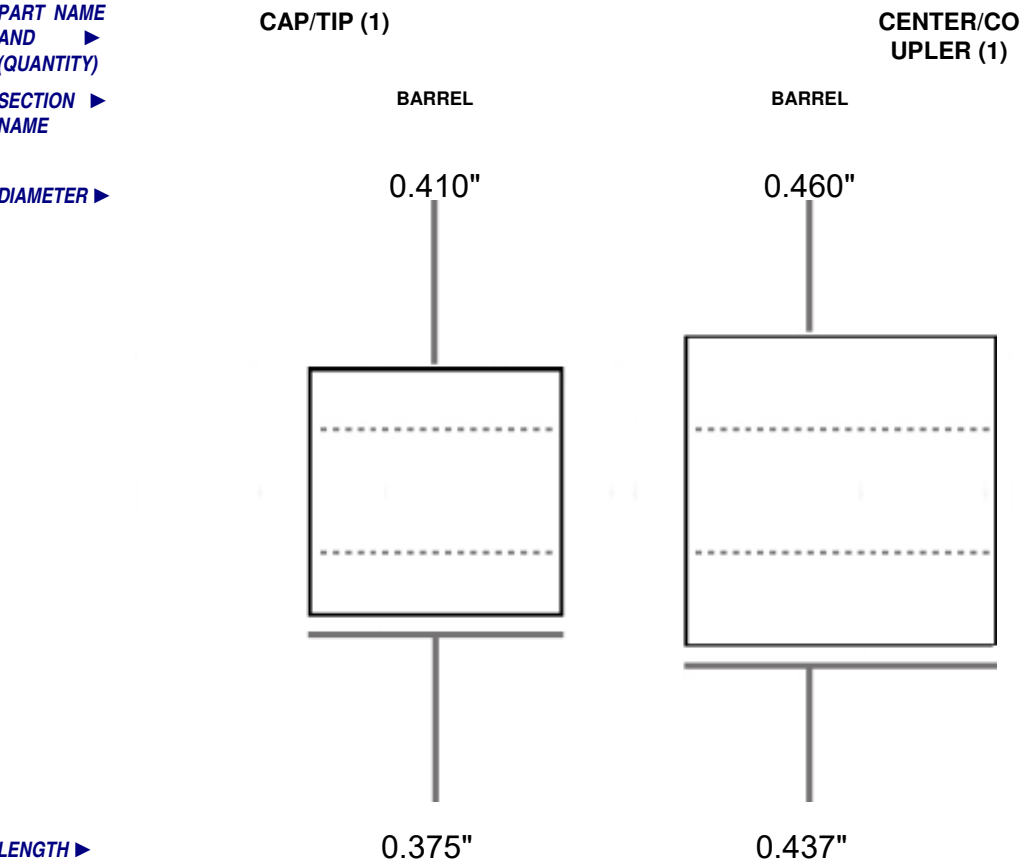

ASSOCIATED PKSEGLO(XX), PKSEGMAG(XX), PKSEGPEN(XX)
KITS:

PICTURE IS AN APPROXIMATE REPRESENTATION. NOT TO EXACT SCALE OR PROPORTION. ALL MEASUREMENTS IN INCHES. BUSHING DIAMETERS (TOP ROW) ARE OPTIMAL AND SHOULD VARY BY NO MORE THAN .002" WHEN NEW.

ID NUMBER PKSEPILLBU **TYPE:** BUSHING

NOTES: BOTH BUSHINGS SAME DIMENSION

NUMBER OF PARTS 2

THRU HOLE STANDARD (0.248')

PART NAME AND (QUANTITY)

SECTION NAME

DIAMETER

LENGTH

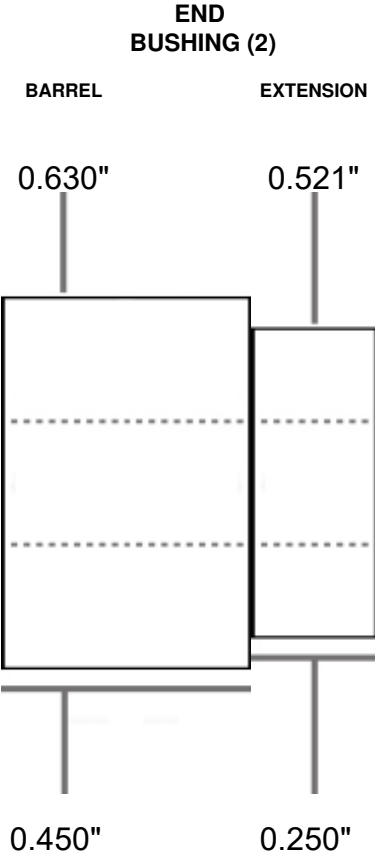

ASSOCIATED PKSEPILL(XX)
KITS:

PICTURE IS AN APPROXIMATE REPRESENTATION. NOT TO EXACT SCALE OR PROPORTION. ALL MEASUREMENTS IN INCHES. BUSHING DIAMETERS (TOP ROW) ARE OPTIMAL AND SHOULD VARY BY NO MORE THAN .002" WHEN NEW.

ID NUMBER PKSERBU

TYPE: BUSHING

NOTES:

NUMBER OF PARTS 3

THRU HOLE STANDARD (0.248')

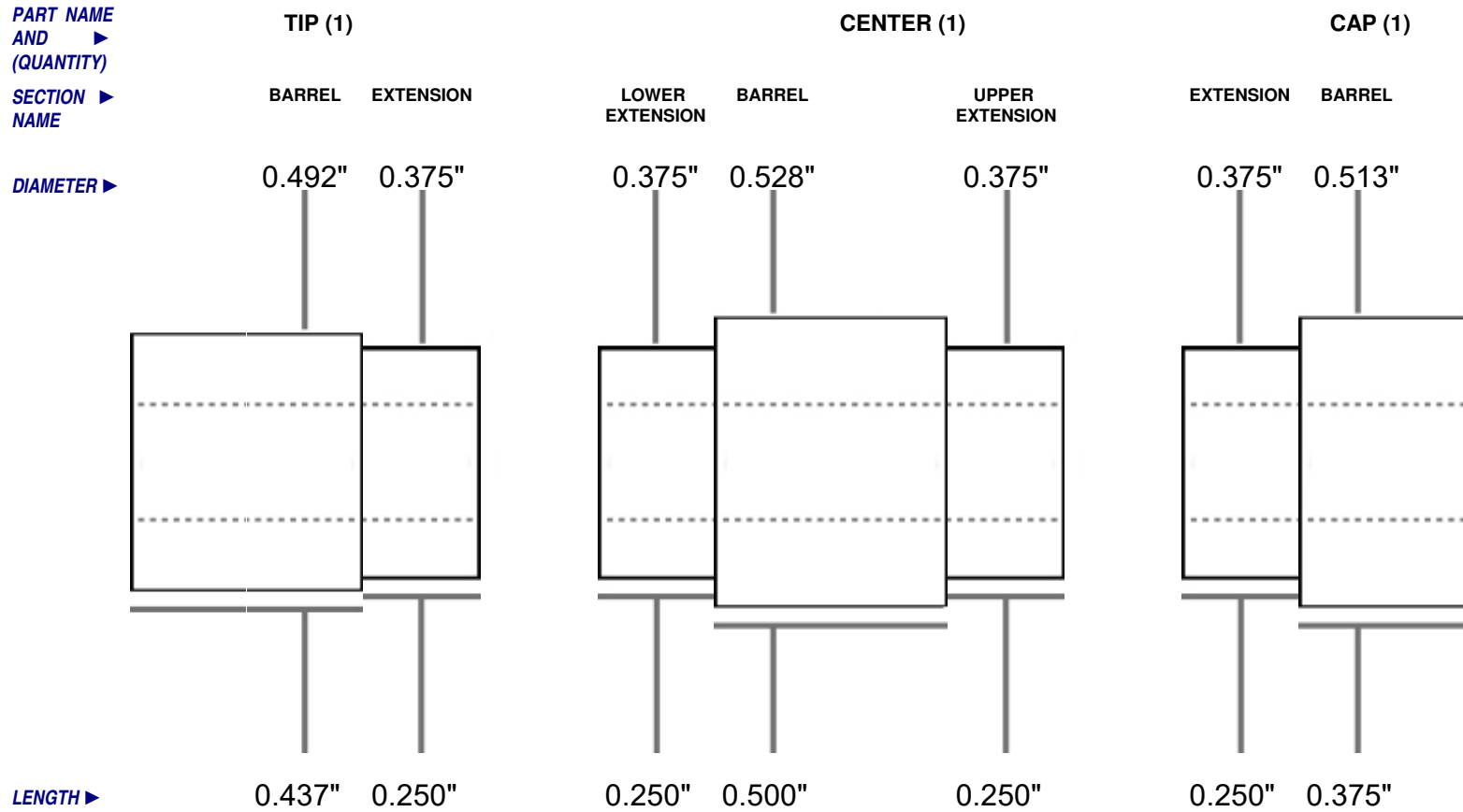

ASSOCIATED PKSER(XX)

KITS:

PICTURE IS AN APPROXIMATE REPRESENTATION. NOT TO EXACT SCALE OR PROPORTION. ALL MEASUREMENTS IN INCHES. BUSHING DIAMETERS (TOP ROW) ARE OPTIMAL AND SHOULD VARY BY NO MORE THAN .002" WHEN NEW.

ID NUMBER PKSHAKEBU **TYPE:** BUSHING

NOTES: END BUSHINGS MATCH EACH OTHER

NUMBER OF PARTS 3

THRU HOLE STANDARD (0.248')

PART NAME AND (QUANTITY)

SECTION NAME

DIAMETER

LENGTH

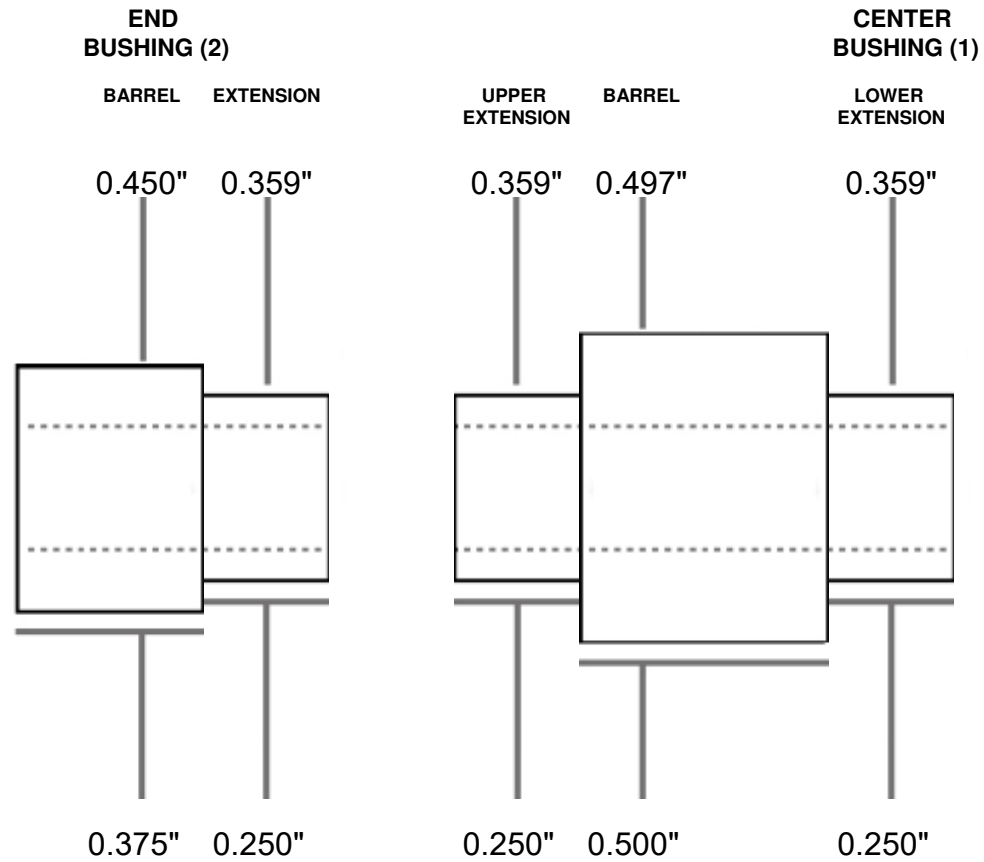

ASSOCIATED PKCAT(XX), PKSHA(XX)
KITS:

PICTURE IS AN APPROXIMATE REPRESENTATION. NOT TO EXACT SCALE OR PROPORTION. ALL MEASUREMENTS IN INCHES. BUSHING DIAMETERS (TOP ROW) ARE OPTIMAL AND SHOULD VARY BY NO MORE THAN .002" WHEN NEW.

ID NUMBER PKSKULLBU **TYPE:** BUSHING

NOTES: CAP AND TIP BUSHINGS SAME DIMENSIONS

NUMBER OF PARTS 3

THRU HOLE STANDARD(0.248")

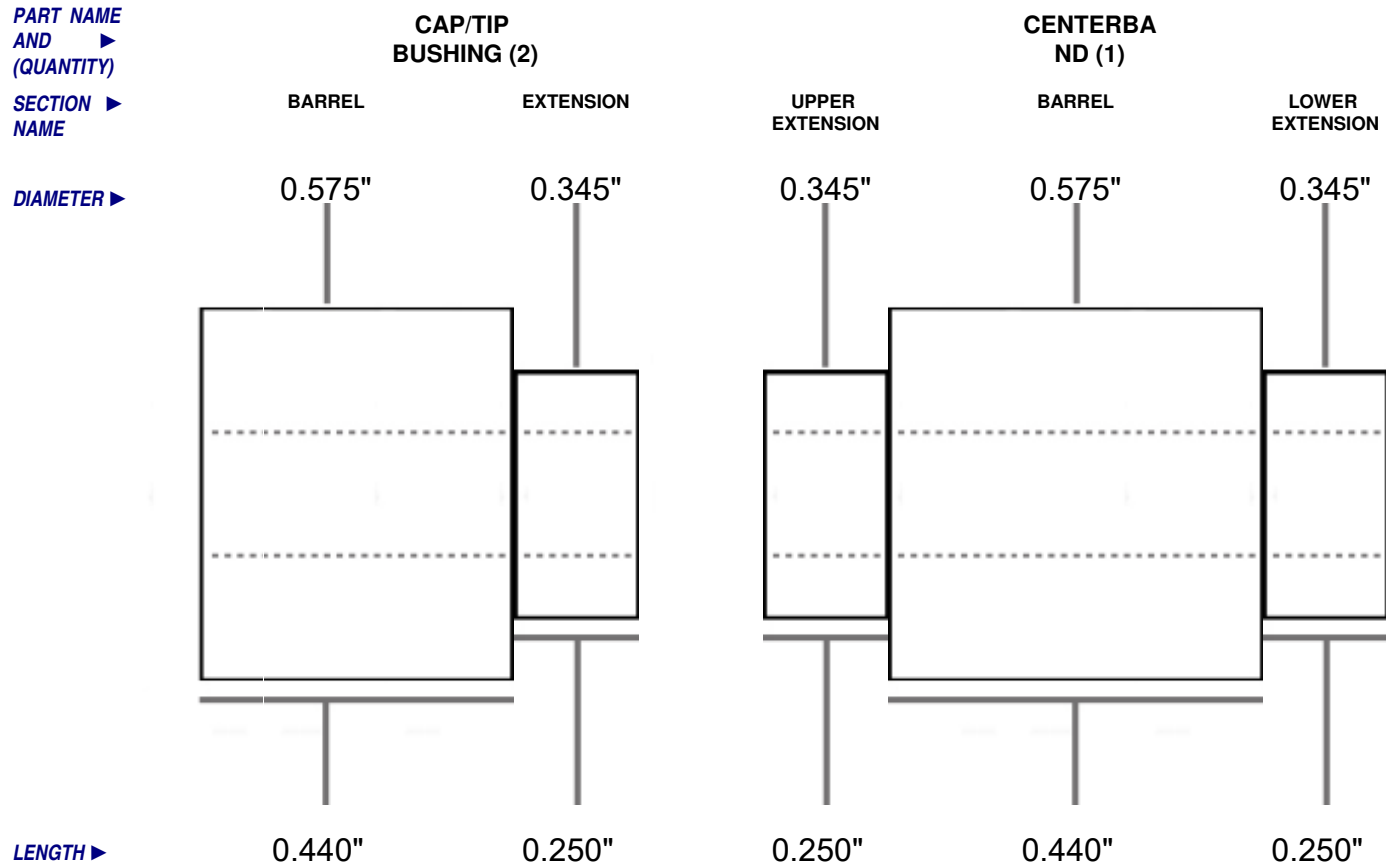

ASSOCIATED PKSKULL(XX)
KITS:

PICTURE IS AN APPROXIMATE REPRESENTATION. NOT TO EXACT SCALE OR PROPORTION. ALL MEASUREMENTS IN INCHES. BUSHING DIAMETERS (TOP ROW) ARE OPTIMAL AND SHOULD VARY BY NO MORE THAN .002" WHEN NEW.

ID NUMBER PKSKULLRBU **TYPE:** BUSHING

NOTES:

NUMBER OF PARTS 3

THRU HOLE STANDARD (0.248')

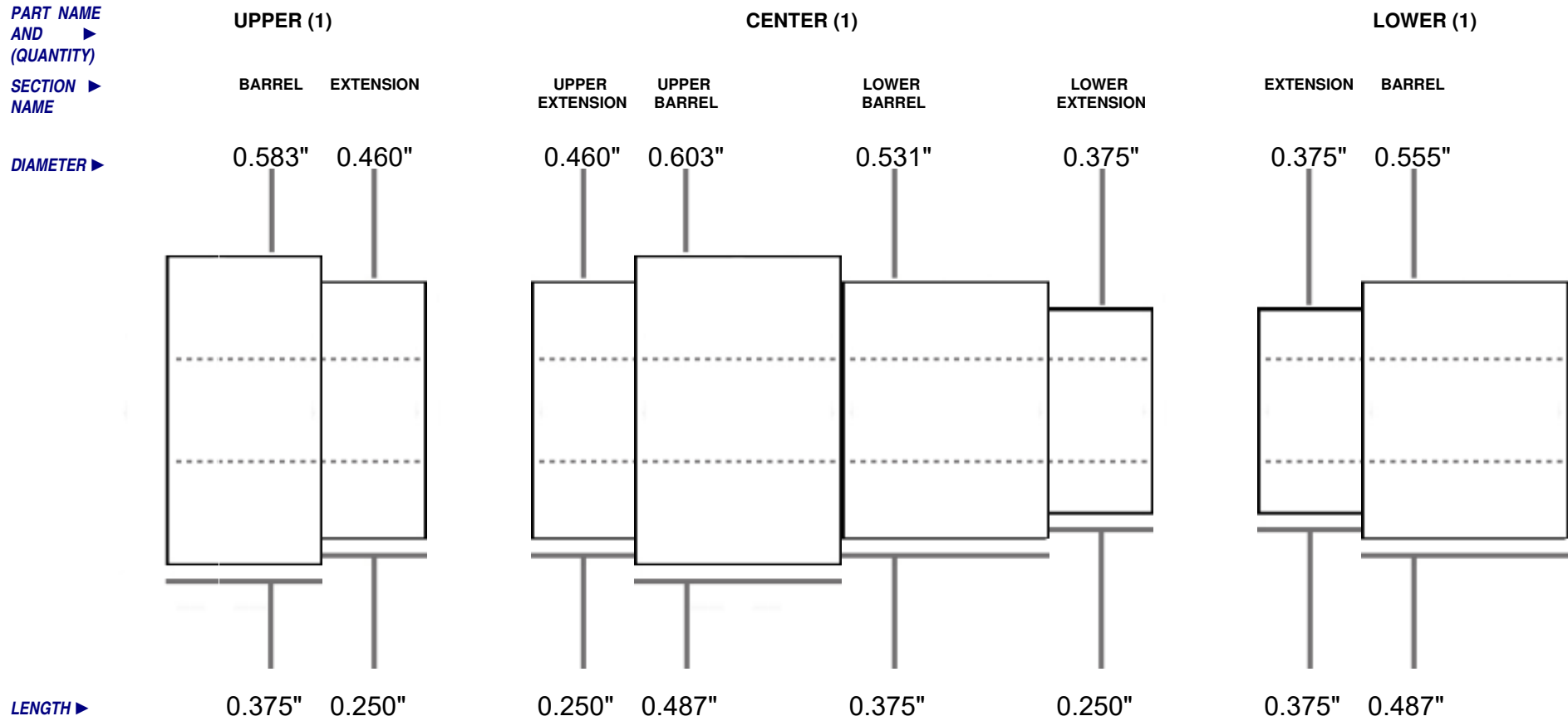

ASSOCIATED PKSKULLF(XX), PKSKULLR(XX)
KITS:

PICTURE IS AN APPROXIMATE REPRESENTATION. NOT TO EXACT SCALE OR PROPORTION. ALL MEASUREMENTS IN INCHES. BUSHING DIAMETERS (TOP ROW) ARE OPTIMAL AND SHOULD VARY BY NO MORE THAN .002" WHEN NEW.

ID NUMBER PKSPBU
NUMBER OF PARTS 2

TYPE: BUSHING

NOTES: SLOT IS FOR PRESSING ON BACK END OF STEAMPUMP KIT. IT STRADDLES LEVER TO AVOID DAMAGING MECHANISM.

THRU HOLE STANDARD (0.248')

PART NAME AND (QUANTITY)

SECTION NAME

DIAMETER

LENGTH

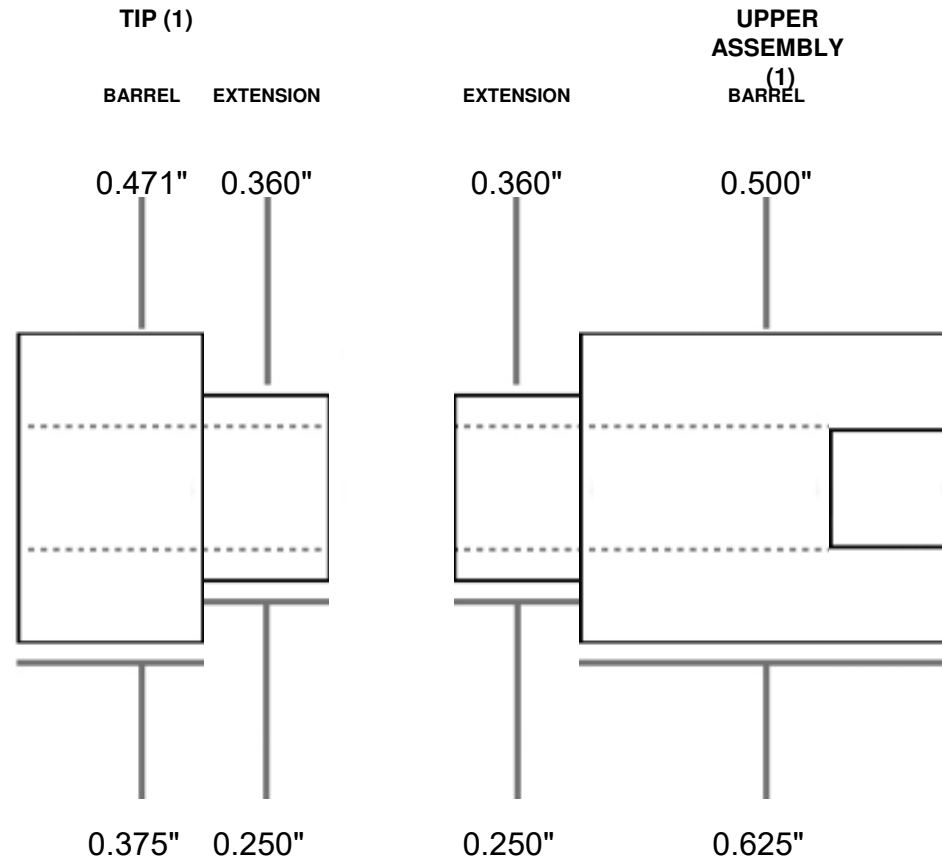

ASSOCIATED KITS: PKSP(XX)

PICTURE IS AN APPROXIMATE REPRESENTATION. NOT TO EXACT SCALE OR PROPORTION. ALL MEASUREMENTS IN INCHES. BUSHING DIAMETERS (TOP ROW) ARE OPTIMAL AND SHOULD VARY BY NO MORE THAN .002" WHEN NEW.

ID NUMBER PKSPCL2BU **TYPE:** BUSHING

NOTES:

NUMBER OF PARTS 2

THRU HOLE STANDARD(0.248")

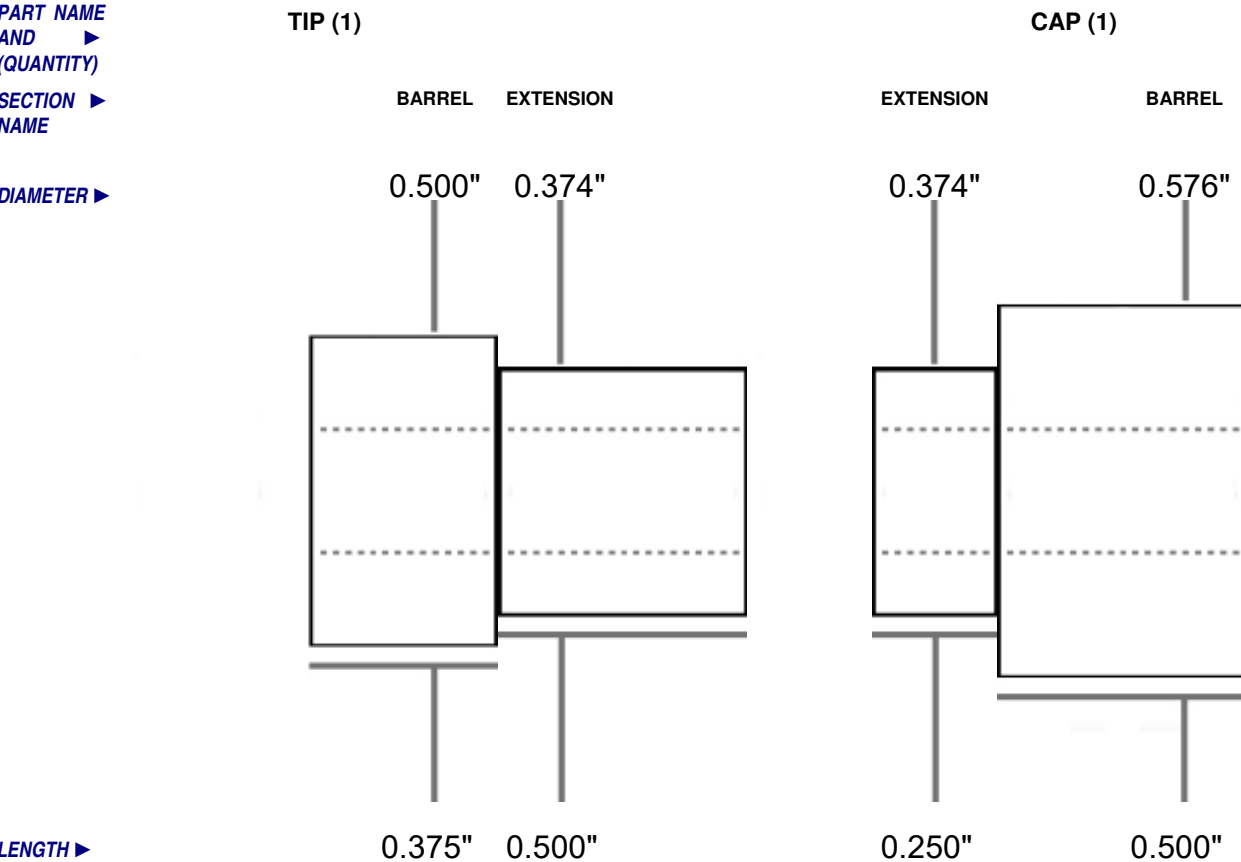

ASSOCIATED PKSPCL2(XX)
KITS:

PICTURE IS AN APPROXIMATE REPRESENTATION. NOT TO EXACT SCALE OR PROPORTION. ALL MEASUREMENTS IN INCHES. BUSHING DIAMETERS (TOP ROW) ARE OPTIMAL AND SHOULD VARY BY NO MORE THAN .002" WHEN NEW.

ID NUMBER PKSPCL3BU **TYPE:** BUSHING

NOTES: TOP/BOTTOM SAME DIMENSIONS

NUMBER OF PARTS 2

THRU HOLE STANDARD (0.248')

PART NAME AND (QUANTITY)

SECTION NAME

DIAMETER

LENGTH

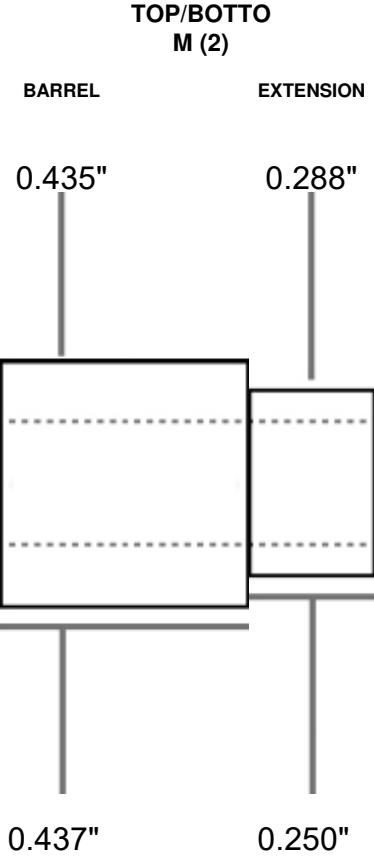

ASSOCIATED KITS: PKEDCD(XX), PKEDCDPL(XX), PKEDCL(XX), PKSPCL3(XX)

PICTURE IS AN APPROXIMATE REPRESENTATION. NOT TO EXACT SCALE OR PROPORTION. ALL MEASUREMENTS IN INCHES. BUSHING DIAMETERS (TOP ROW) ARE OPTIMAL AND SHOULD VARY BY NO MORE THAN .002" WHEN NEW.

ID NUMBER PKSPCLBU **TYPE:** BUSHING

NOTES: TIP AND CAP SAME DIMENSION

NUMBER OF PARTS 3

THRU HOLE STANDARD(0.248")

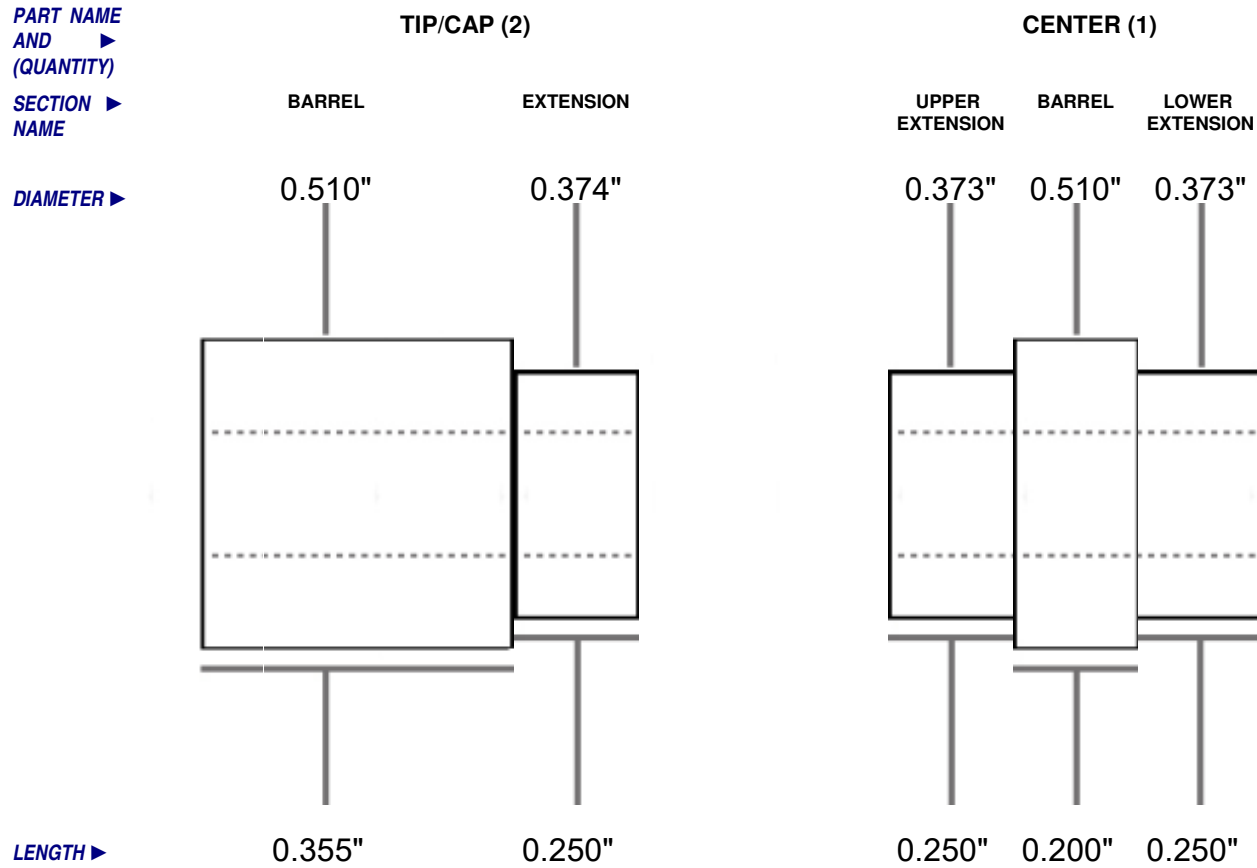

ASSOCIATED PKSPCL(XX)
KITS:

PICTURE IS AN APPROXIMATE REPRESENTATION. NOT TO EXACT SCALE OR PROPORTION. ALL MEASUREMENTS IN INCHES. BUSHING DIAMETERS (TOP ROW) ARE OPTIMAL AND SHOULD VARY BY NO MORE THAN .002" WHEN NEW.

ID NUMBER PKSPDRBU **TYPE:** BUSHING

NOTES: BOTH BUSHINGS SAME DIMENSIONS

NUMBER OF PARTS 2

THRU HOLE STANDARD (0.248')

PART NAME AND (QUANTITY)

SECTION NAME

DIAMETER

LENGTH

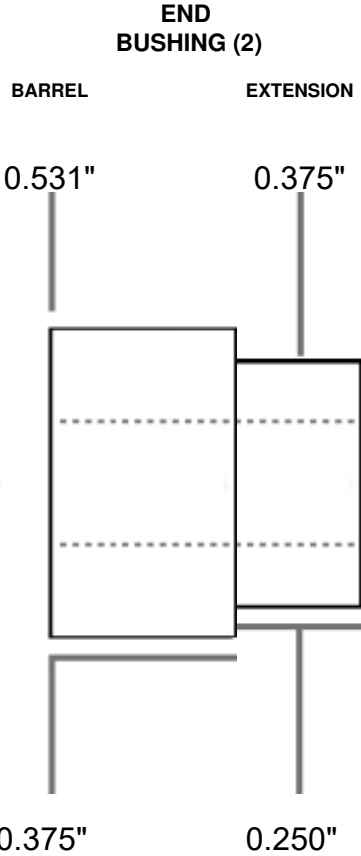

ASSOCIATED PKSPDR(XX)
KITS:

PICTURE IS AN APPROXIMATE REPRESENTATION. NOT TO EXACT SCALE OR PROPORTION. ALL MEASUREMENTS IN INCHES. BUSHING DIAMETERS (TOP ROW) ARE OPTIMAL AND SHOULD VARY BY NO MORE THAN .002" WHEN NEW.

ID NUMBER PKSPENBU **TYPE:** BUSHING

NOTES: TIP/CAP SAME DIAMETERS. PEN CENTERBAND IS RECESSED, MEANING SMALLER THAN THE BARREL

NUMBER OF PARTS 3

THRU HOLE STANDARD (0.248')

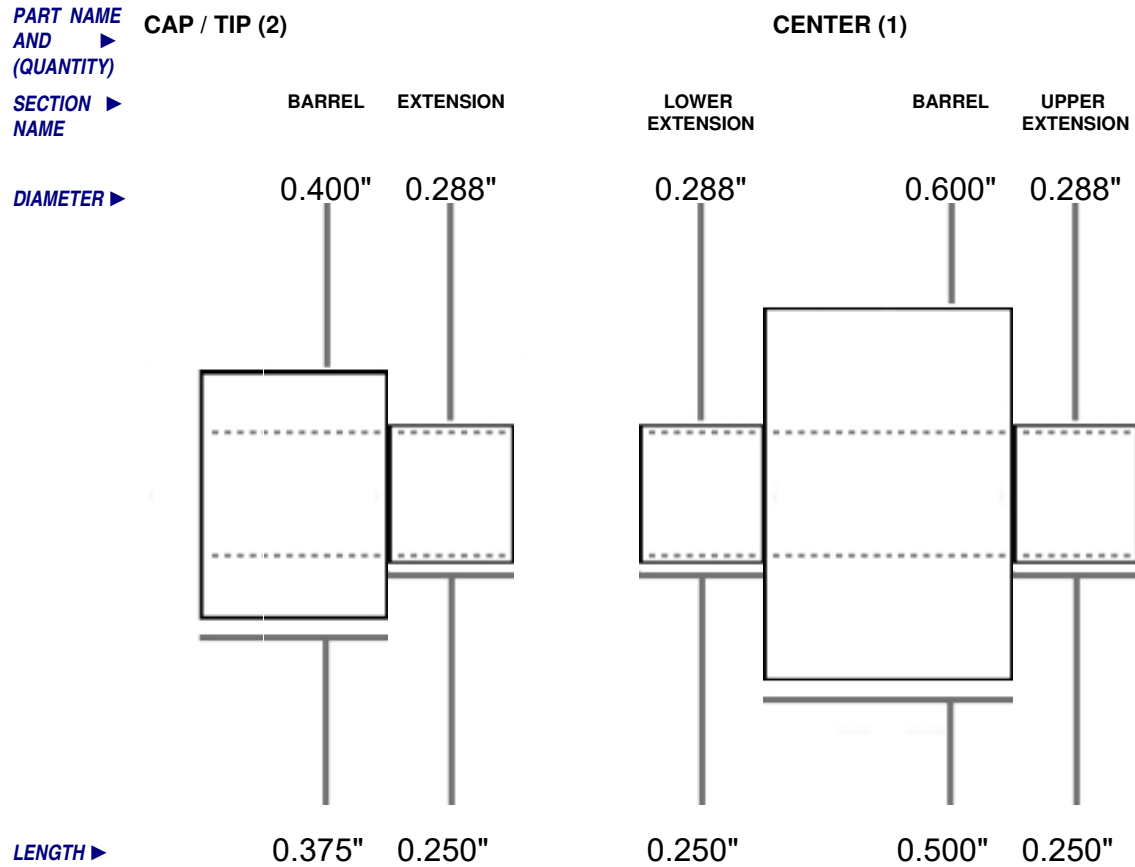

ASSOCIATED PKSPEN(XX)
KITS:

PICTURE IS AN APPROXIMATE REPRESENTATION. NOT TO EXACT SCALE OR PROPORTION. ALL MEASUREMENTS IN INCHES. BUSHING DIAMETERS (TOP ROW) ARE OPTIMAL AND SHOULD VARY BY NO MORE THAN .002" WHEN NEW.

ID NUMBER PKSPKSBU

TYPE: BUSHING

NOTES:

NUMBER OF PARTS 2

THRU HOLE STANDARD (0.248')

PART NAME AND (QUANTITY)

SECTION NAME

DIAMETER

LENGTH

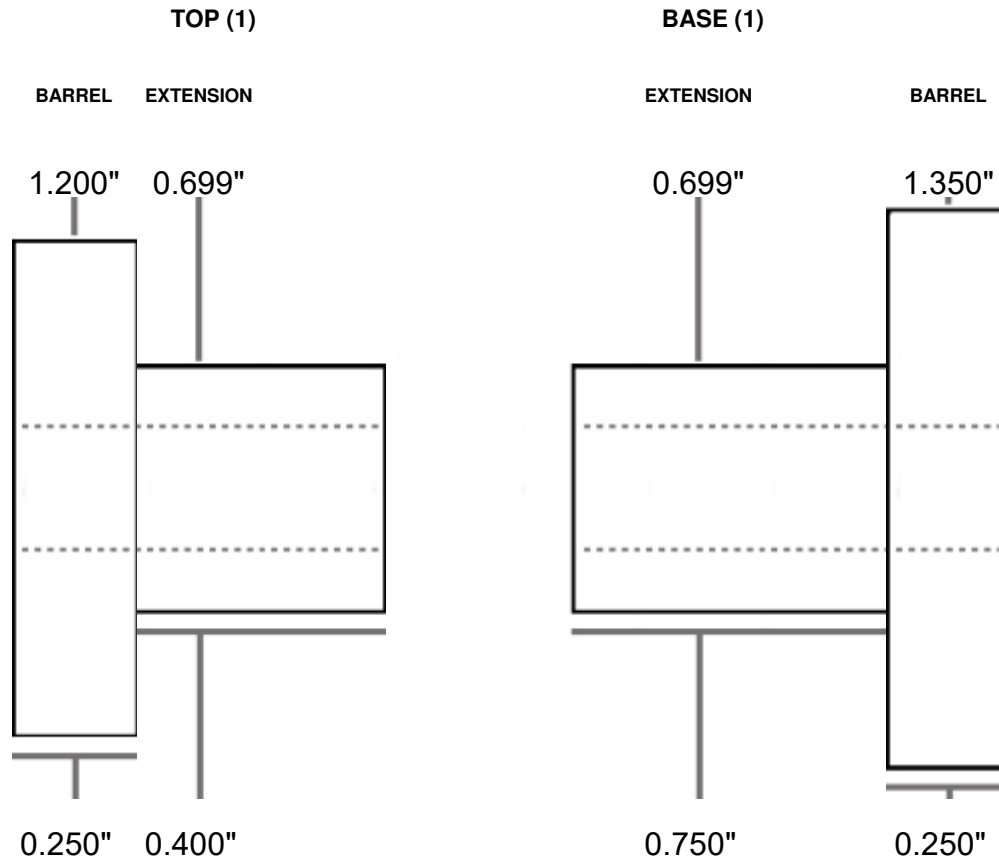

ASSOCIATED KSSP(XX)

KITS:

PICTURE IS AN APPROXIMATE REPRESENTATION. NOT TO EXACT SCALE OR PROPORTION. ALL MEASUREMENTS IN INCHES. BUSHING DIAMETERS (TOP ROW) ARE OPTIMAL AND SHOULD VARY BY NO MORE THAN .002" WHEN NEW.

ID NUMBER PKSPRTBU

TYPE: BUSHING

NOTES:

NUMBER OF PARTS 2

THRU HOLE STANDARD (0.248')

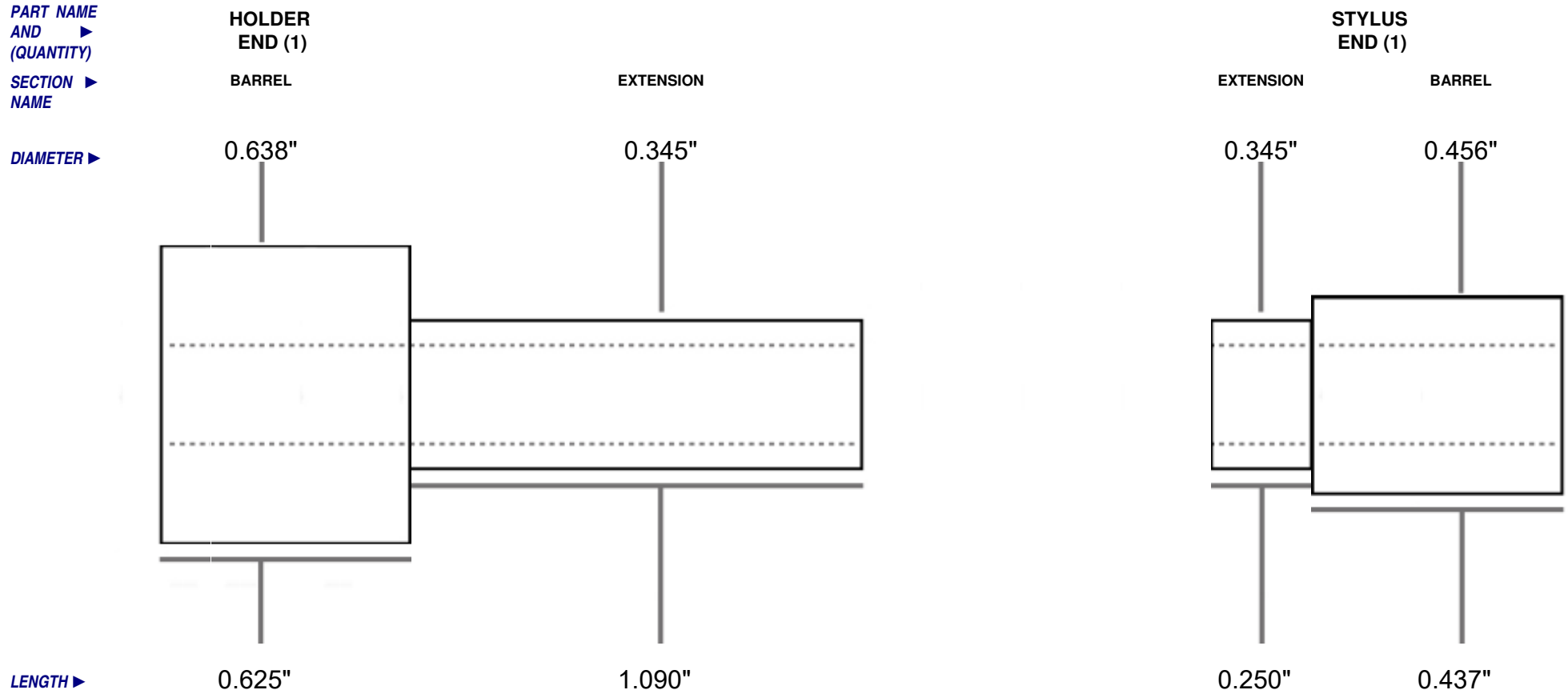

ASSOCIATED PKSPRT(XX)

KITS:

PICTURE IS AN APPROXIMATE REPRESENTATION. NOT TO EXACT SCALE OR PROPORTION. ALL MEASUREMENTS IN INCHES. BUSHING DIAMETERS (TOP ROW) ARE OPTIMAL AND SHOULD VARY BY NO MORE THAN .002" WHEN NEW.

ID NUMBER PKSRBU **TYPE:** BUSHING

NOTES: CAP END IS ONLY USED FOR SINGLE BLADE KITS.
DOUBLE KITS USE 2 BLADE ENDS

NUMBER OF PARTS 3

THRU HOLE STANDARD(0.248")

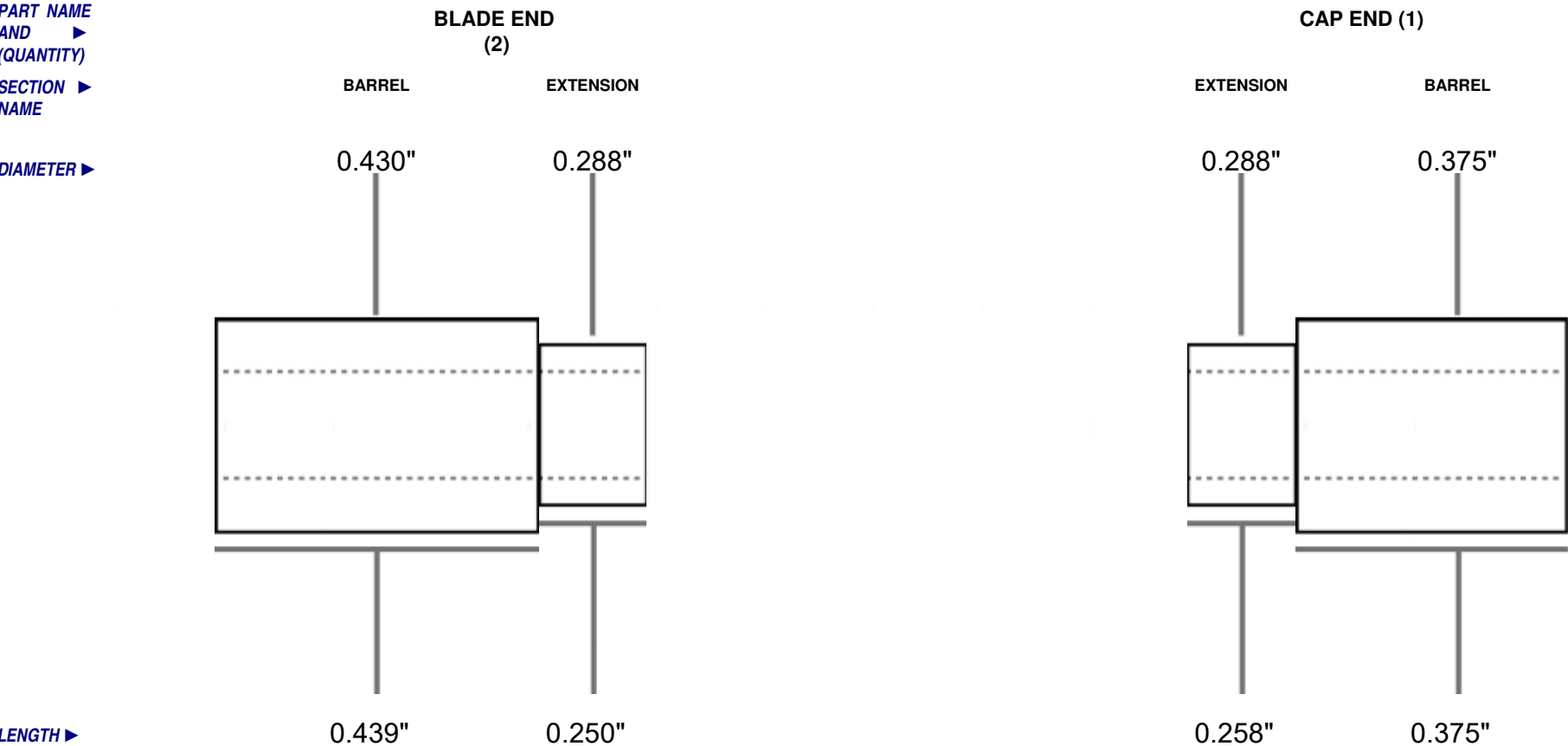

ASSOCIATED KITS: PKCROCHET(XX), PKCRONEC(XX), PKSR1(XX), PKSR2(XX), PKSR3(XX), PKSR4(XX), PKSRN(XX), PKSRNT(XX)

PICTURE IS AN APPROXIMATE REPRESENTATION. NOT TO EXACT SCALE OR PROPORTION. ALL MEASUREMENTS IN INCHES. BUSHING DIAMETERS (TOP ROW) ARE OPTIMAL AND SHOULD VARY BY NO MORE THAN .002" WHEN NEW.

ID NUMBER PKSTANDYBU **TYPE:** BUSHING

NOTES:

NUMBER OF PARTS 2

THRU HOLE STANDARD (0.248')

PART NAME AND (QUANTITY)

SECTION NAME

DIAMETER

LENGTH

BOTTOM (1)

TOP (1)

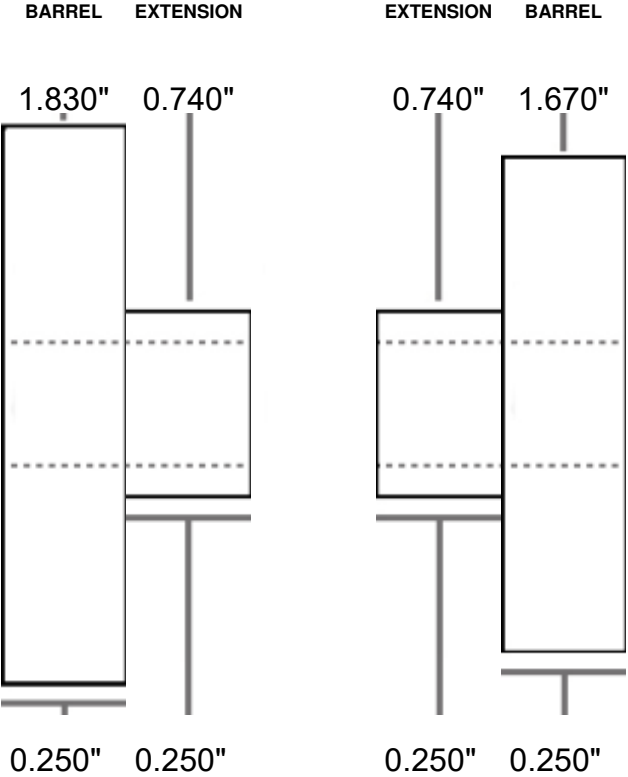

ASSOCIATED PKSTANDY(XX)
KITS:

PICTURE IS AN APPROXIMATE REPRESENTATION. NOT TO EXACT SCALE OR PROPORTION. ALL MEASUREMENTS IN INCHES. BUSHING DIAMETERS (TOP ROW) ARE OPTIMAL AND SHOULD VARY BY NO MORE THAN .002" WHEN NEW.

ID NUMBER PKSWPBU

TYPE: BUSHING

NOTES:

NUMBER OF PARTS 3

THRU HOLE STANDARD(0.248")

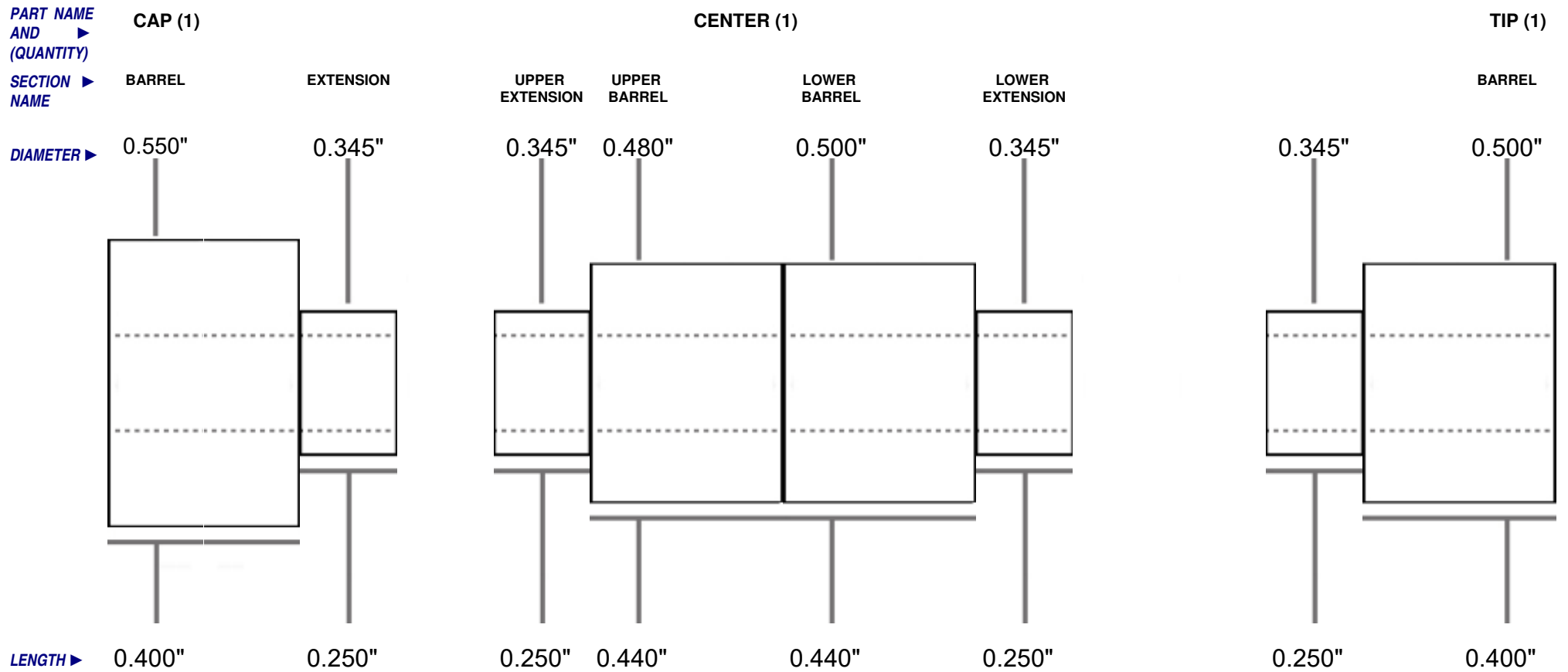

ASSOCIATED PKSW(XX)

KITS:

PICTURE IS AN APPROXIMATE REPRESENTATION. NOT TO EXACT SCALE OR PROPORTION. ALL MEASUREMENTS IN INCHES. BUSHING DIAMETERS (TOP ROW) ARE OPTIMAL AND SHOULD VARY BY NO MORE THAN .002" WHEN NEW.

ID NUMBER PKTANKBU **TYPE:** BUSHING

NOTES: CAP AND TIP HAVE SAME DIMENSIONS

NUMBER OF PARTS 2

THRU HOLE STANDARD (0.248')

PART NAME AND (QUANTITY)

SECTION NAME

DIAMETER

LENGTH

ASSOCIATED PKTANK(XX)
KITS:

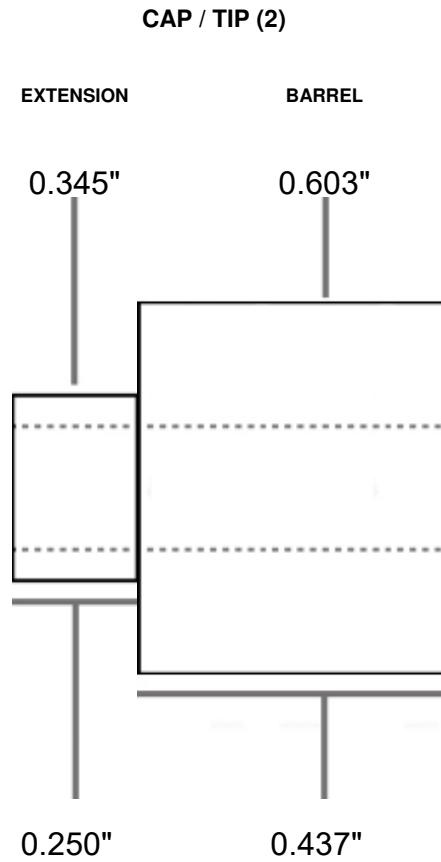

PICTURE IS AN APPROXIMATE REPRESENTATION. NOT TO EXACT SCALE OR PROPORTION. ALL MEASUREMENTS IN INCHES. BUSHING DIAMETERS (TOP ROW) ARE OPTIMAL AND SHOULD VARY BY NO MORE THAN .002" WHEN NEW.

ID NUMBER PKTOOL2BU **TYPE:** BUSHING

NOTES: TIP/CAP SAME DIMENSIONS

NUMBER OF PARTS 2

THRU HOLE STANDARD (0.248')

PART NAME AND (QUANTITY)

SECTION NAME

DIAMETER

LENGTH

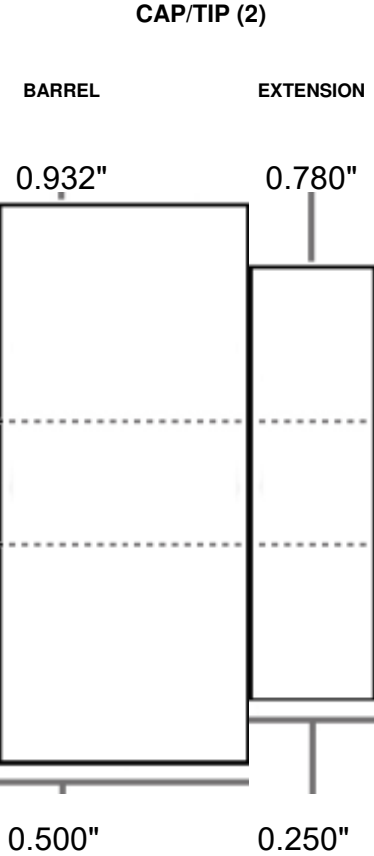

ASSOCIATED KITS: PKRABHKIT2(XX)

PICTURE IS AN APPROXIMATE REPRESENTATION. NOT TO EXACT SCALE OR PROPORTION. ALL MEASUREMENTS IN INCHES. BUSHING DIAMETERS (TOP ROW) ARE OPTIMAL AND SHOULD VARY BY NO MORE THAN .002" WHEN NEW.

ID NUMBER PKTPENBU **TYPE:** BUSHING

NOTES: CAP/TIP SAME DIMENSION

NUMBER OF PARTS 2

THRU HOLE STANDARD (0.248')

PART NAME AND (QUANTITY)

SECTION NAME

DIAMETER

LENGTH

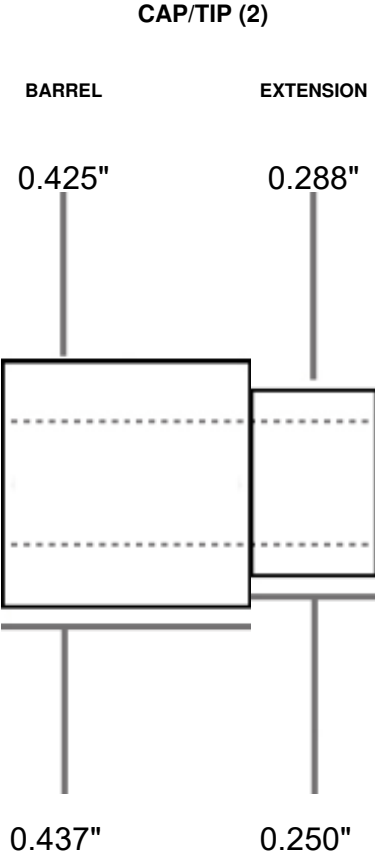

ASSOCIATED PKTPEN(XX)
KITS:

PICTURE IS AN APPROXIMATE REPRESENTATION. NOT TO EXACT SCALE OR PROPORTION. ALL MEASUREMENTS IN INCHES. BUSHING DIAMETERS (TOP ROW) ARE OPTIMAL AND SHOULD VARY BY NO MORE THAN .002" WHEN NEW.

ID NUMBER PKTS100BU

TYPE: BUSHING

NOTES:

NUMBER OF PARTS 2

THRU HOLE STANDARD (0.248')

PART NAME AND (QUANTITY)

SECTION NAME

DIAMETER

CAP END (1)

STYLUS END (1)

BARREL

BARREL

0.510"

0.380"

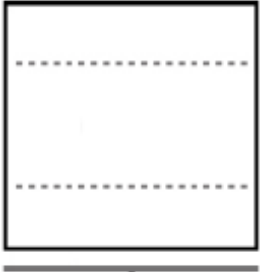

0.437"

0.375"

LENGTH

ASSOCIATED KITS: PKTS1(XX)

PICTURE IS AN APPROXIMATE REPRESENTATION. NOT TO EXACT SCALE OR PROPORTION. ALL MEASUREMENTS IN INCHES. BUSHING DIAMETERS (TOP ROW) ARE OPTIMAL AND SHOULD VARY BY NO MORE THAN .002" WHEN NEW.

ID NUMBER PKTSTECBU **TYPE:** BUSHING

NOTES:

NUMBER OF PARTS 3

THRU HOLE STANDARD(0.248")

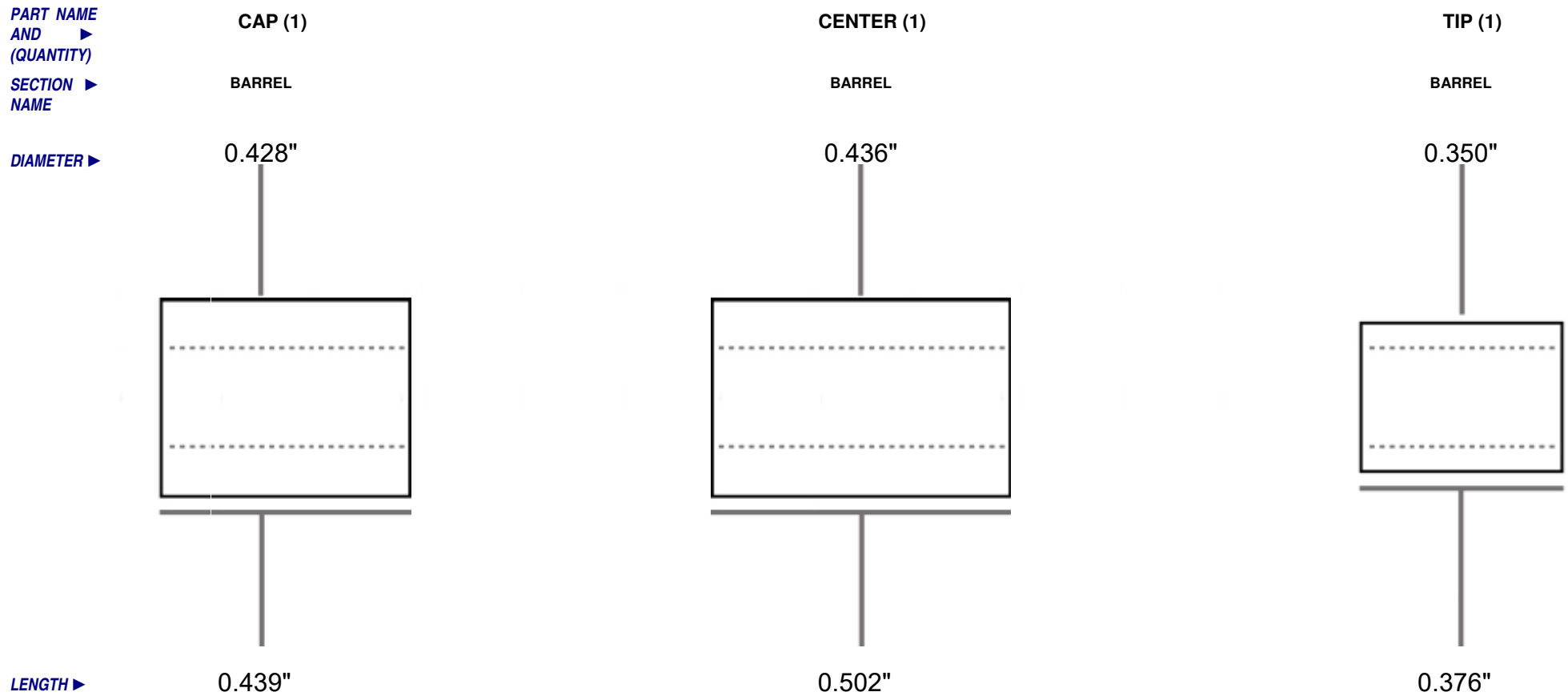

ASSOCIATED PKTSTEC(XX)
KITS:

PICTURE IS AN APPROXIMATE REPRESENTATION. NOT TO EXACT SCALE OR PROPORTION. ALL MEASUREMENTS IN INCHES. BUSHING DIAMETERS (TOP ROW) ARE OPTIMAL AND SHOULD VARY BY NO MORE THAN .002" WHEN NEW.

ID NUMBER PKTYBTS **TYPE:** TRIMMING SLEEVE
NUMBER OF PARTS 2

NOTES: FITS STANDARD TUBES SIZED 15/32" (UPPER) AND 25/64" (LOWER)

THRU HOLE ACCEPTS 7MM TRIMMER SHAFT

PART NAME AND (QUANTITY)

UPPER (1)

LOWER (1)

SECTION NAME

BARREL

BARREL

DIAMETER

0.428"

0.356"

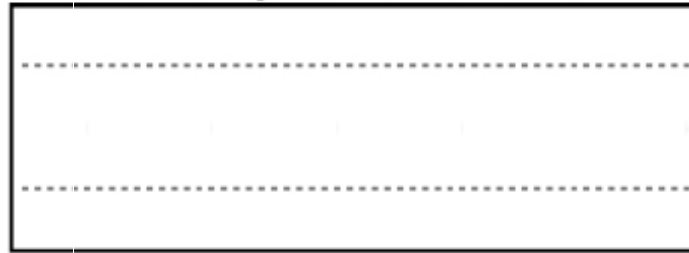

LENGTH

1.690"

1.937"

ASSOCIATED KITS:

PICTURE IS AN APPROXIMATE REPRESENTATION. NOT TO EXACT SCALE OR PROPORTION. ALL MEASUREMENTS IN INCHES. BUSHING DIAMETERS (TOP ROW) ARE OPTIMAL AND SHOULD VARY BY NO MORE THAN .002" WHEN NEW.

ID NUMBER PKTYBU

TYPE: BUSHING

NOTES:

NUMBER OF PARTS 3

THRU HOLE STANDARD(0.248")

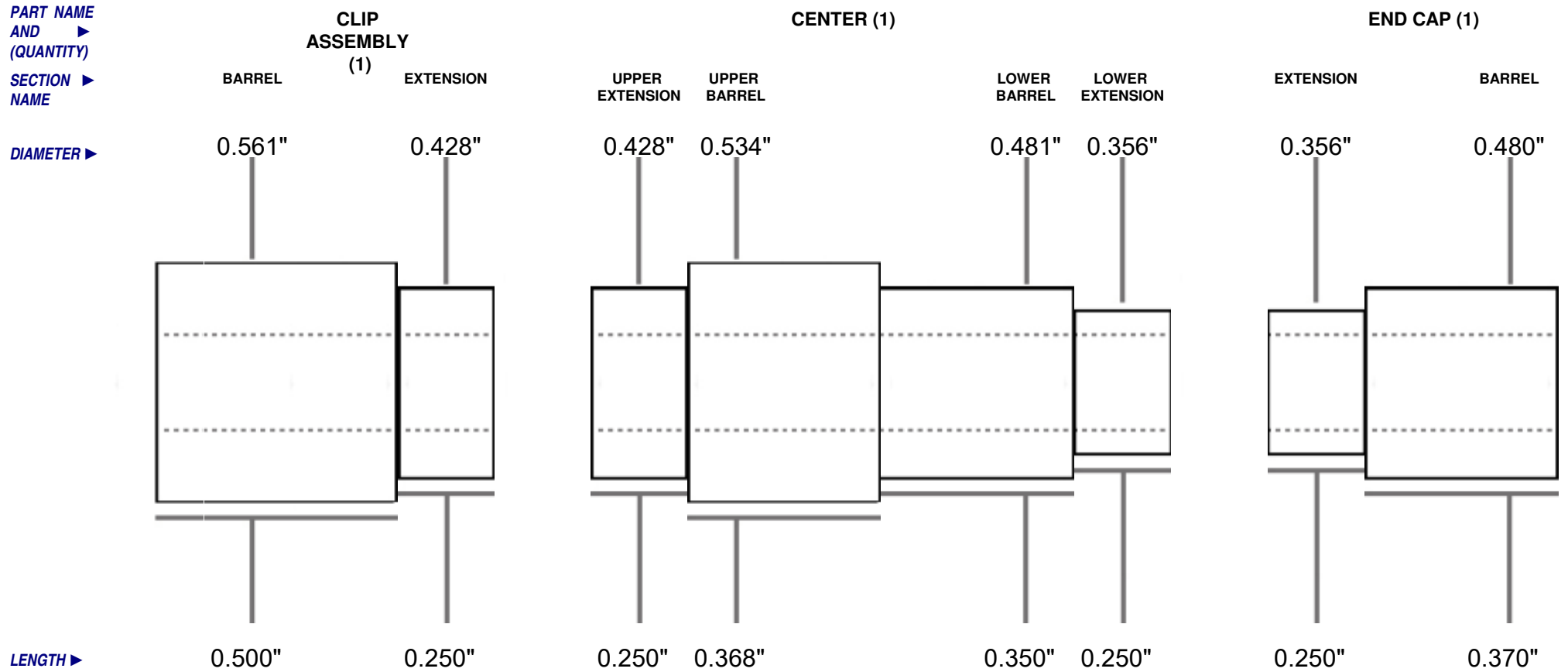

ASSOCIATED PKTYFP(XX), PKTYRB(XX)

KITS:

PICTURE IS AN APPROXIMATE REPRESENTATION. NOT TO EXACT SCALE OR PROPORTION. ALL MEASUREMENTS IN INCHES. BUSHING DIAMETERS (TOP ROW) ARE OPTIMAL AND SHOULD VARY BY NO MORE THAN .002" WHEN NEW.

ID NUMBER PKTYCEBU **TYPE:** BUSHING

NOTES: USED IN "BIG GRABBER" CLOSED END SYSTEM. ONE BUSHING IS USED FOR EACH BARREL

NUMBER OF PARTS 2

THRU HOLE STANDARD (0.248')

PART NAME AND (QUANTITY)
SECTION NAME

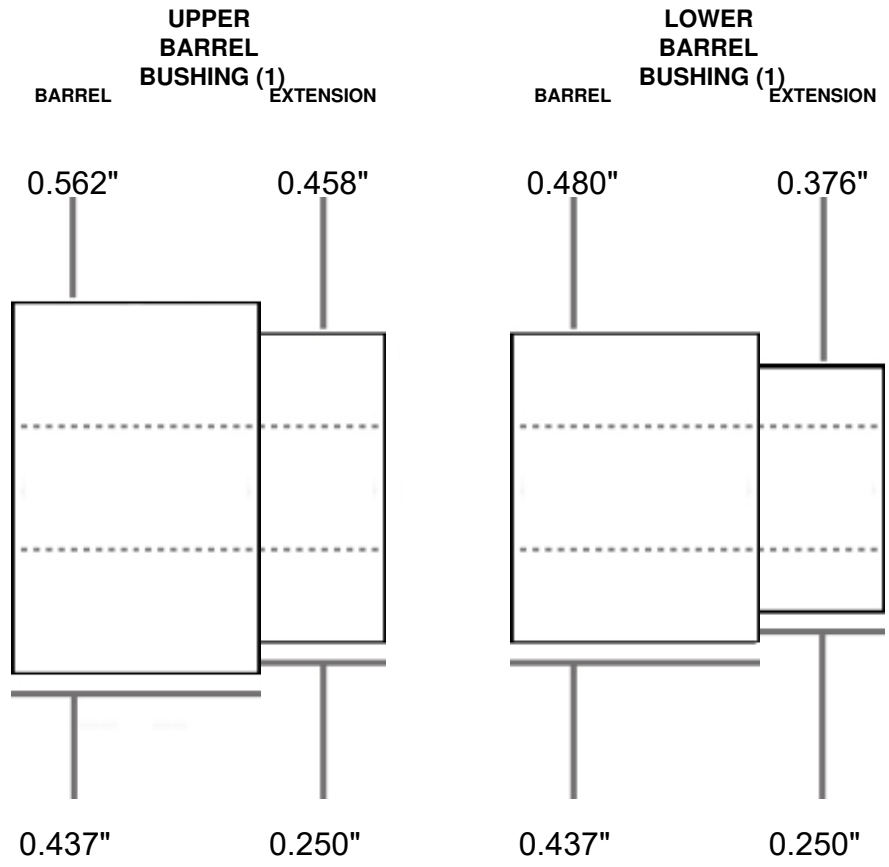

DIAMETER

LENGTH

ASSOCIATED PKTYCF(XX), PKTYCR(XX)

KITS:

PICTURE IS AN APPROXIMATE REPRESENTATION. NOT TO EXACT SCALE OR PROPORTION. ALL MEASUREMENTS IN INCHES. BUSHING DIAMETERS (TOP ROW) ARE OPTIMAL AND SHOULD VARY BY NO MORE THAN .002" WHEN NEW.

ID NUMBER PKVESBU

TYPE: BUSHING

NOTES: CAP AND TIP SAME SIZE

NUMBER OF PARTS 2

THRU HOLE STANDARD (0.248')

PART NAME AND (QUANTITY)

SECTION NAME

DIAMETER

CAP/TIP (2)

BARREL EXTENSION

0.474" 0.360"

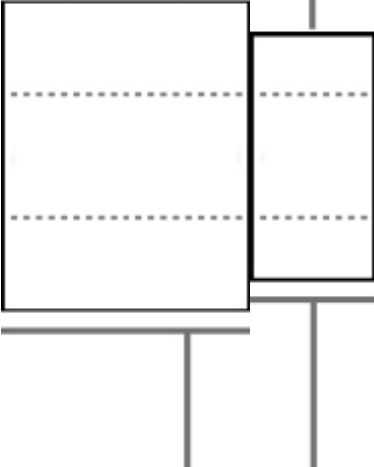

LENGTH

0.438" 0.250"

ASSOCIATED KITS: PK4X(XX), PKVEP(XX), PKVES(XX)

PICTURE IS AN APPROXIMATE REPRESENTATION. NOT TO EXACT SCALE OR PROPORTION. ALL MEASUREMENTS IN INCHES. BUSHING DIAMETERS (TOP ROW) ARE OPTIMAL AND SHOULD VARY BY NO MORE THAN .002" WHEN NEW.

ID NUMBER PKVICBU

TYPE: BUSHING

NOTES: TIP AND CAP ARE SAME DIMENSION

NUMBER OF PARTS 3

THRU HOLE STANDARD(0.248")

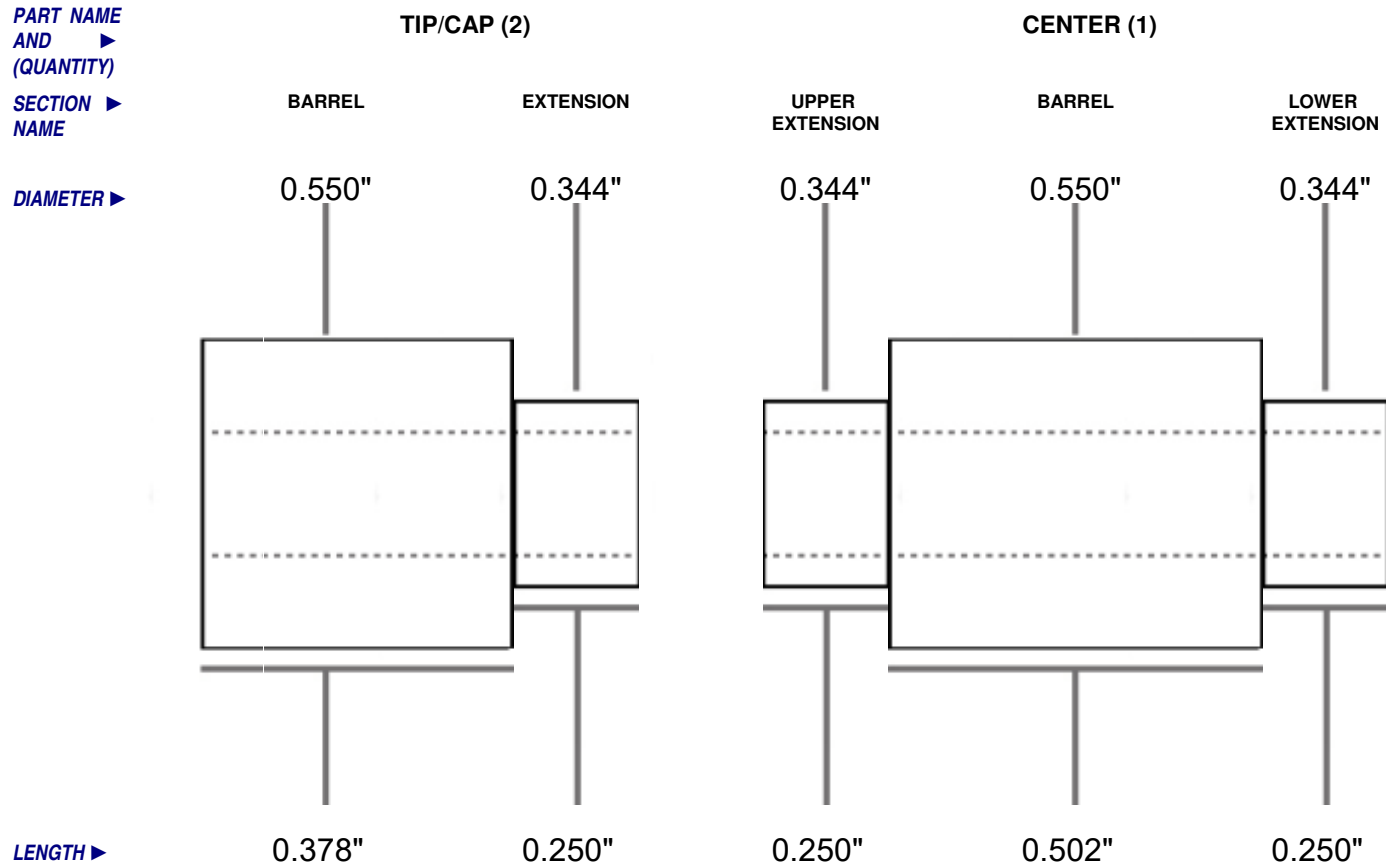

ASSOCIATED PKGAM(XX), PKGTP(XX), PKRISE(XX), PKSPP(XX), PKVIC(XX)

KITS:

PICTURE IS AN APPROXIMATE REPRESENTATION. NOT TO EXACT SCALE OR PROPORTION. ALL MEASUREMENTS IN INCHES. BUSHING DIAMETERS (TOP ROW) ARE OPTIMAL AND SHOULD VARY BY NO MORE THAN .002" WHEN NEW.

ID NUMBER PKVICRBU

TYPE: BUSHING

NOTES:

NUMBER OF PARTS 3

THRU HOLE STANDARD(0.248")

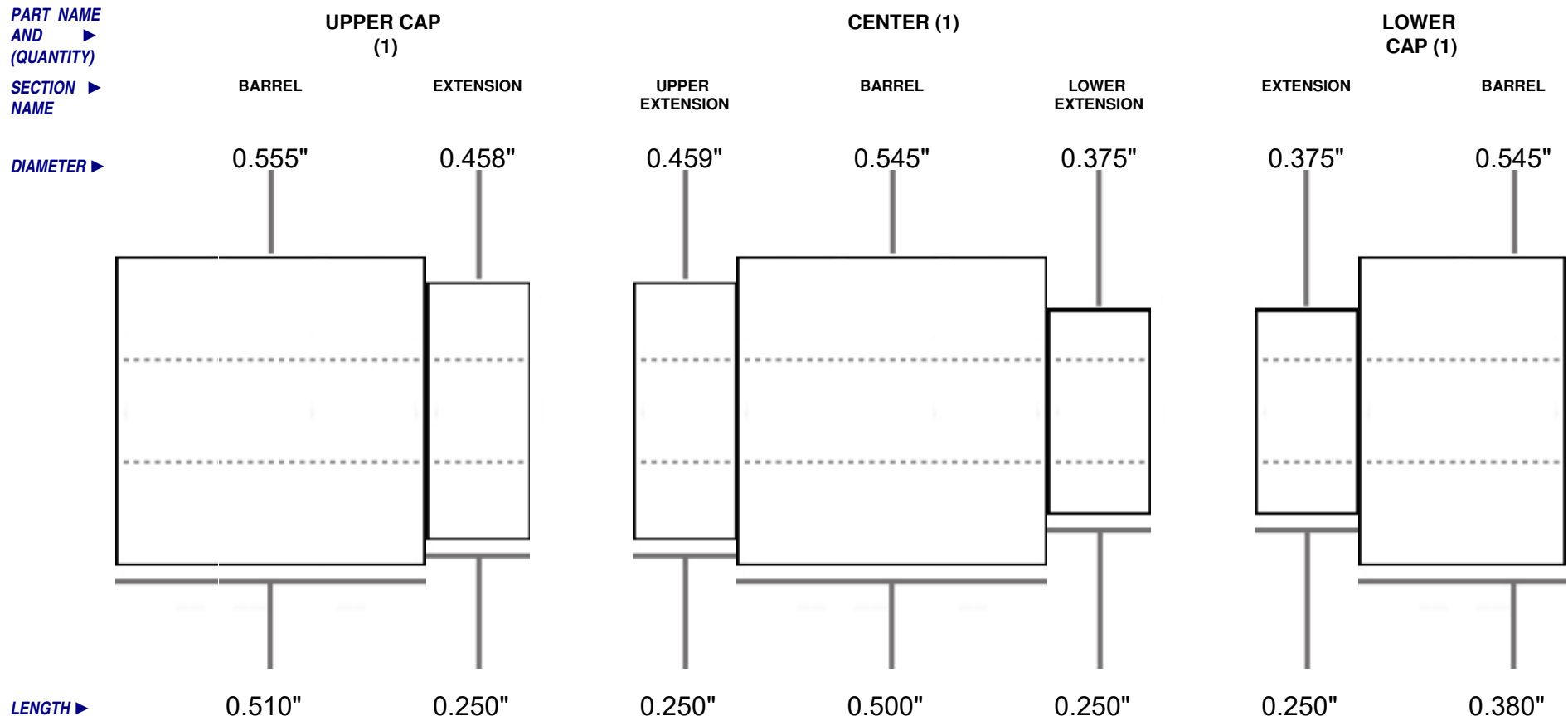

ASSOCIATED PKVICFP(XX), PKVICRB(XX)

KITS:

PICTURE IS AN APPROXIMATE REPRESENTATION. NOT TO EXACT SCALE OR PROPORTION. ALL MEASUREMENTS IN INCHES. BUSHING DIAMETERS (TOP ROW) ARE OPTIMAL AND SHOULD VARY BY NO MORE THAN .002" WHEN NEW.

ID NUMBER PKVPENBU

TYPE: BUSHING

NOTES:

NUMBER OF PARTS 4

THRU HOLE STANDARD(0.248")

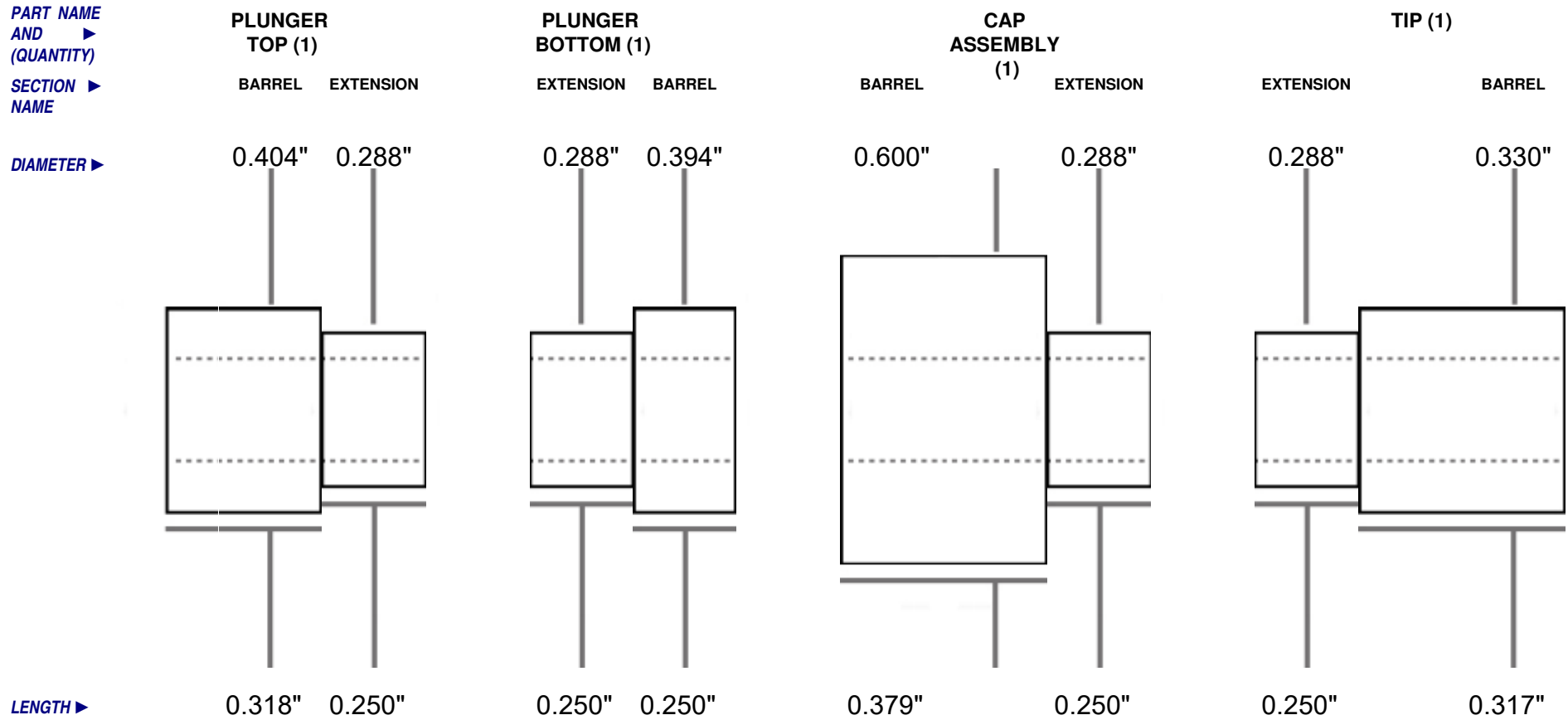

ASSOCIATED PKVPEN(XX)

KITS:

PICTURE IS AN APPROXIMATE REPRESENTATION. NOT TO EXACT SCALE OR PROPORTION. ALL MEASUREMENTS IN INCHES. BUSHING DIAMETERS (TOP ROW) ARE OPTIMAL AND SHOULD VARY BY NO MORE THAN .002" WHEN NEW.

ID NUMBER PKWDYBU

TYPE: BUSHING

NOTES:

NUMBER OF PARTS 2

THRU HOLE STANDARD (0.248')

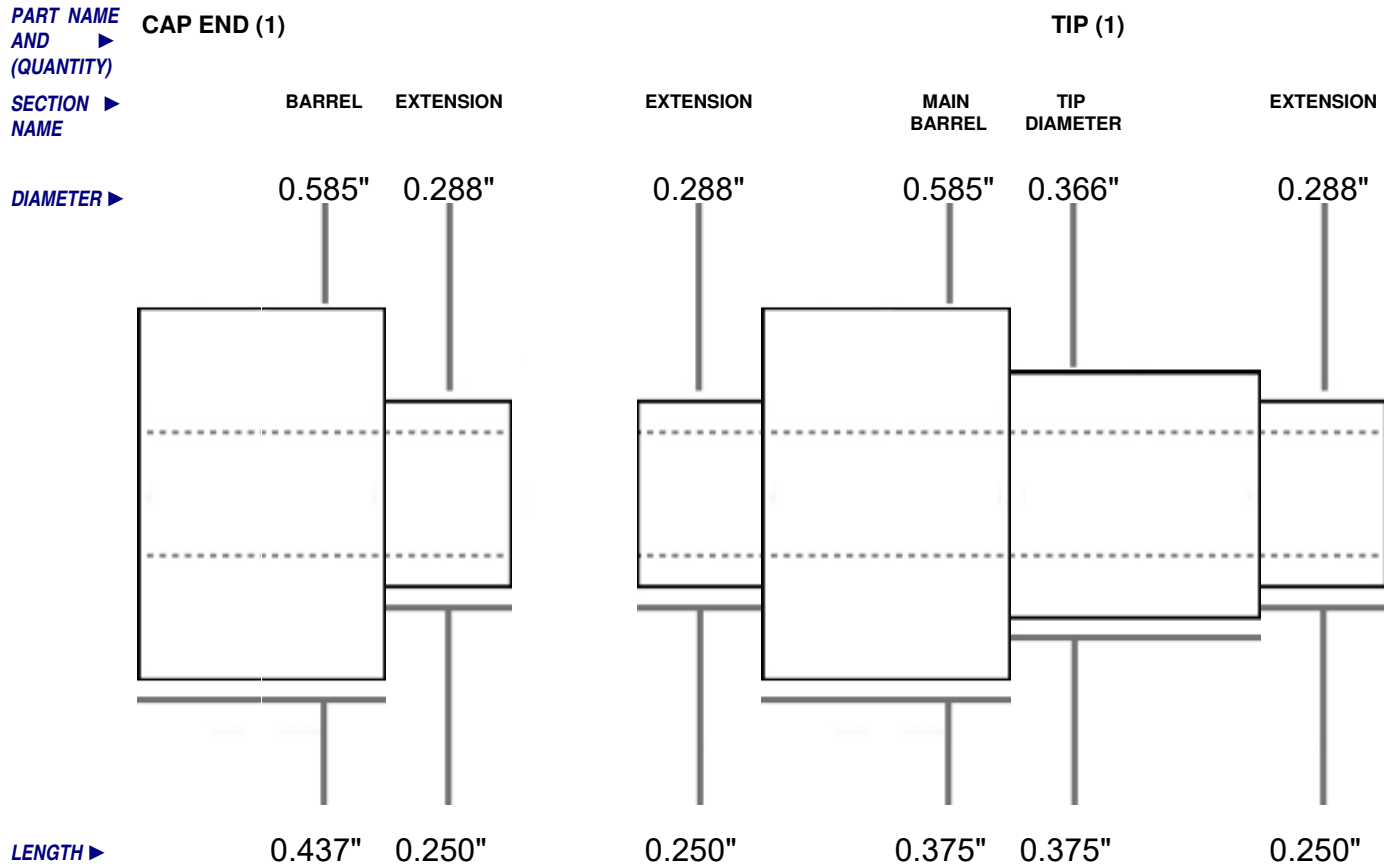

ASSOCIATED PKWDYL(XX), PKWDYP(XX)

KITS:

PICTURE IS AN APPROXIMATE REPRESENTATION. NOT TO EXACT SCALE OR PROPORTION. ALL MEASUREMENTS IN INCHES. BUSHING DIAMETERS (TOP ROW) ARE OPTIMAL AND SHOULD VARY BY NO MORE THAN .002" WHEN NEW.

ID NUMBER PKWESTBU **TYPE:** BUSHING

NOTES:

NUMBER OF PARTS 3

THRU HOLE STANDARD(0.248")

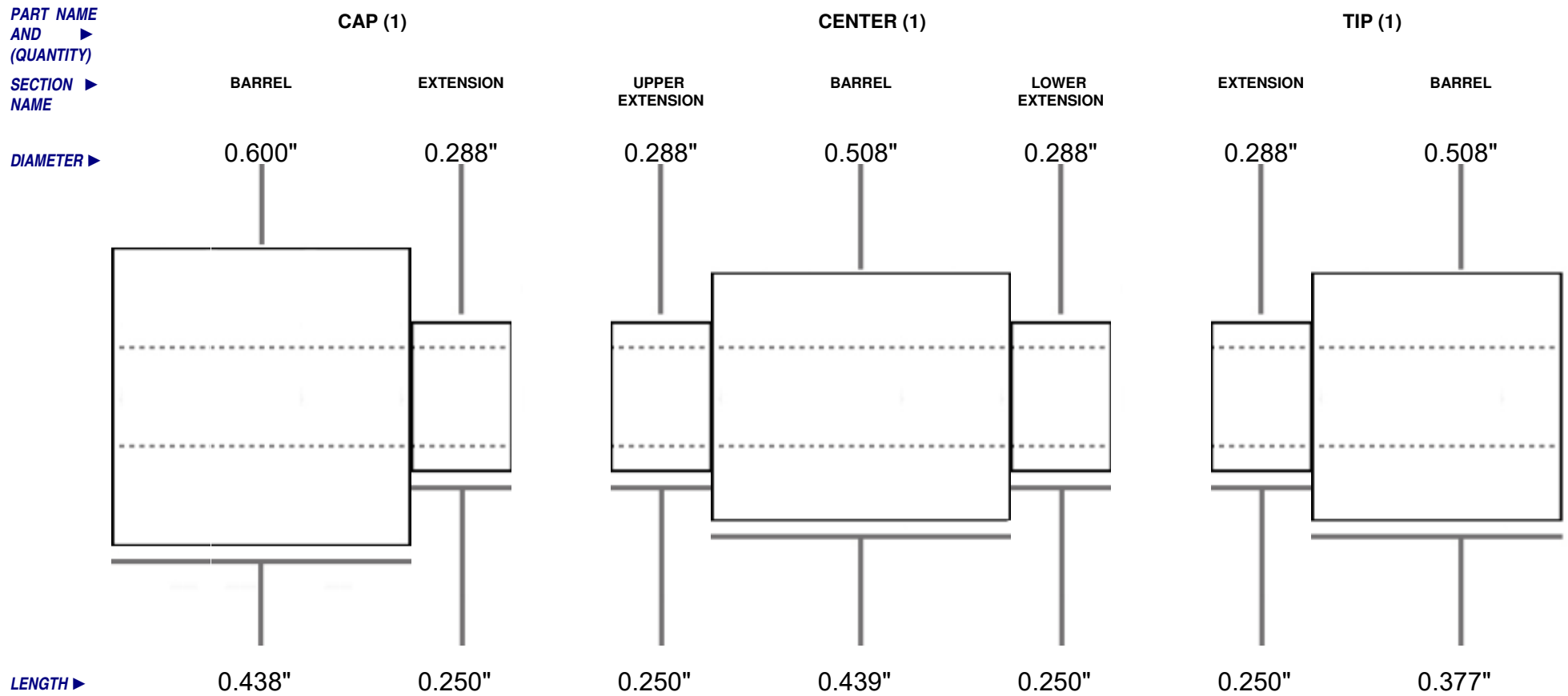

ASSOCIATED PKWEST(XX)
KITS:

PICTURE IS AN APPROXIMATE REPRESENTATION. NOT TO EXACT SCALE OR PROPORTION. ALL MEASUREMENTS IN INCHES. BUSHING DIAMETERS (TOP ROW) ARE OPTIMAL AND SHOULD VARY BY NO MORE THAN .002" WHEN NEW.

ID NUMBER PKXMBU

TYPE: BUSHING

NOTES:

NUMBER OF PARTS 3

THRU HOLE STANDARD(0.248")

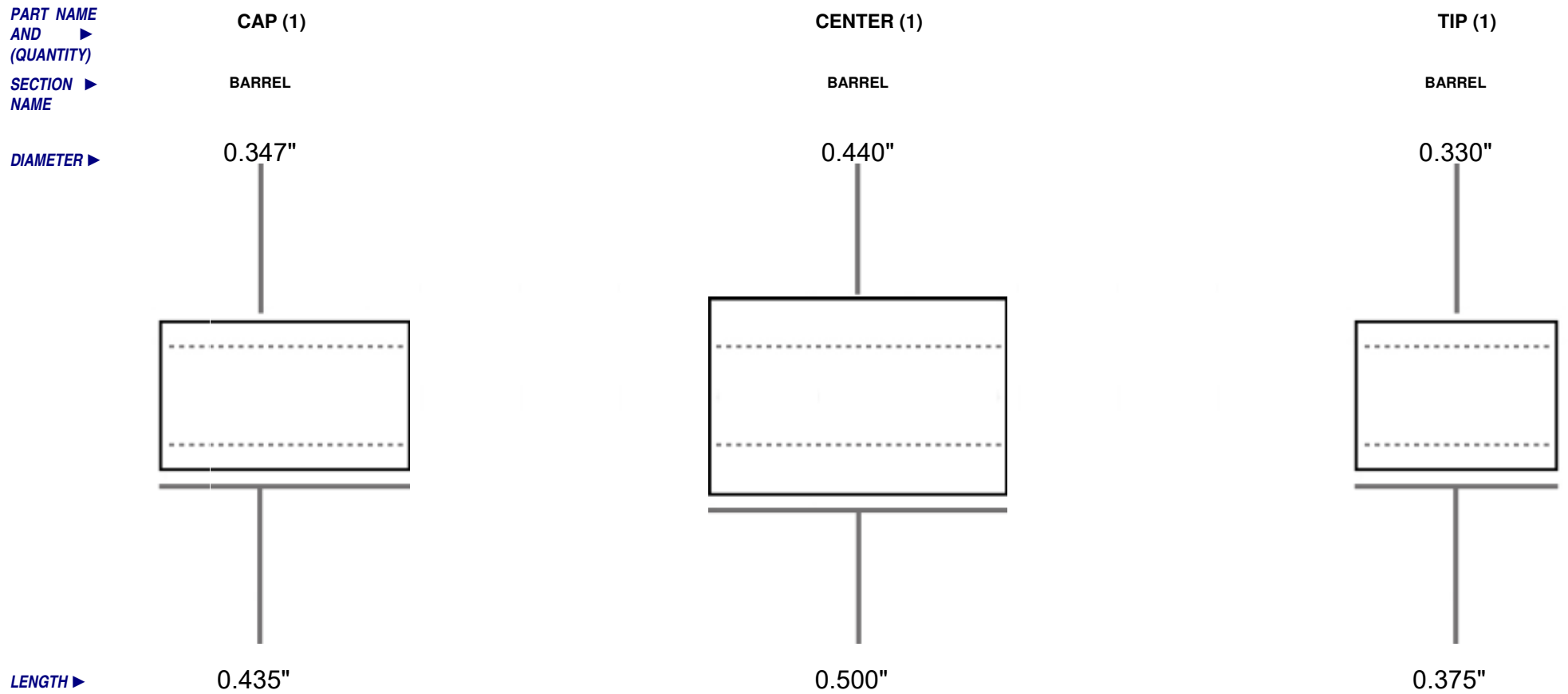

ASSOCIATED PKXM(XX), PKXMPL(XX)

KITS:

PICTURE IS AN APPROXIMATE REPRESENTATION. NOT TO EXACT SCALE OR PROPORTION. ALL MEASUREMENTS IN INCHES. BUSHING DIAMETERS (TOP ROW) ARE OPTIMAL AND SHOULD VARY BY NO MORE THAN .002" WHEN NEW.

ID NUMBER PKYOGABU

TYPE: BUSHING

NOTES:

NUMBER OF PARTS 3

THRU HOLE STANDARD (0.248')

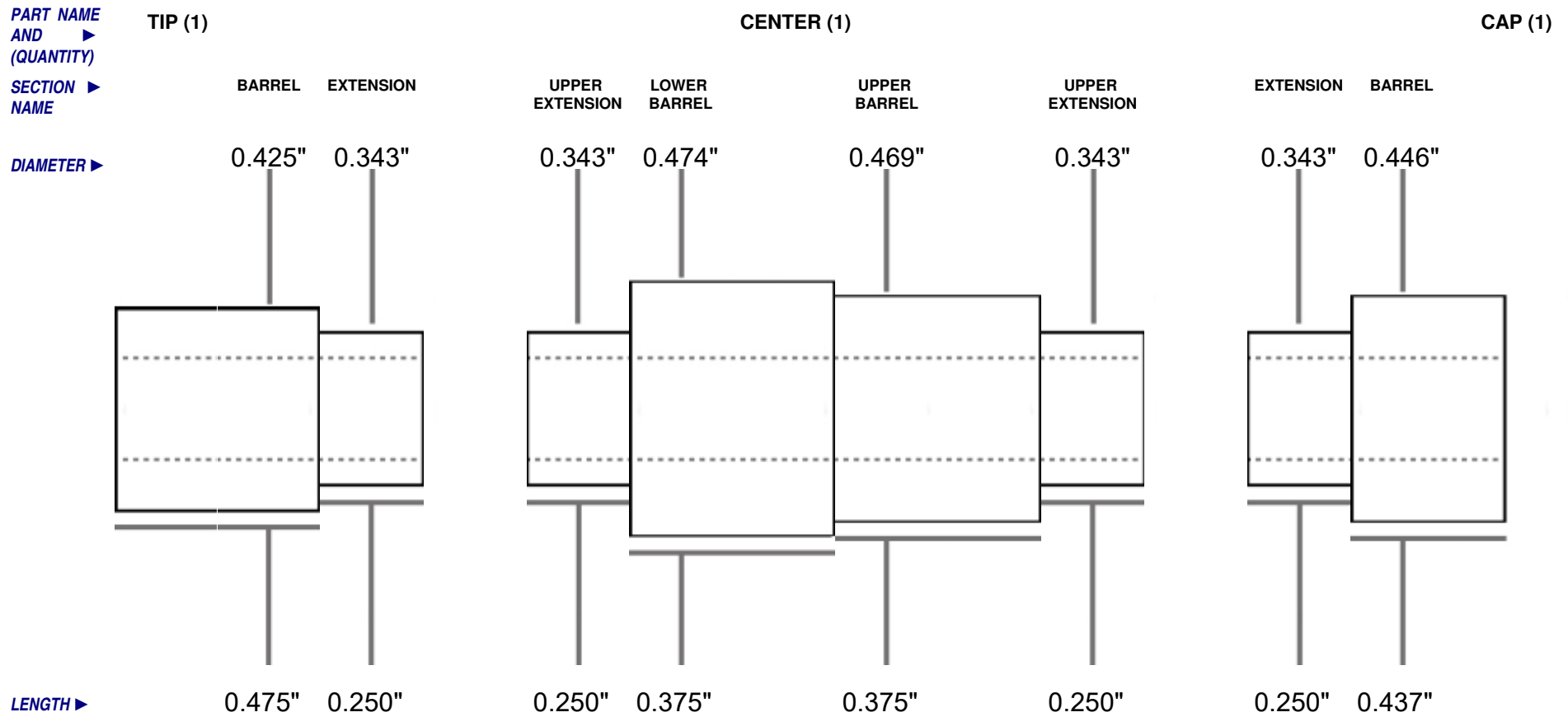

ASSOCIATED PKYOGA(XX)

KITS:

PICTURE IS AN APPROXIMATE REPRESENTATION. NOT TO EXACT SCALE OR PROPORTION. ALL MEASUREMENTS IN INCHES. BUSHING DIAMETERS (TOP ROW) ARE OPTIMAL AND SHOULD VARY BY NO MORE THAN .002" WHEN NEW.

ID NUMBER ZTRIMSET01 **TYPE:** TRIMMING SLEEVE

NOTES: COMES IN PKTRIMSET FITS INSIDE 8MM TUBES.
ACCEPTS 7MM TRIM SHAFT. NOT AVAILABLE SEPARATELY.

NUMBER OF PARTS 1

THRU HOLE ACCEPTS 7MM TRIMMER SHAFT

PART NAME AND (QUANTITY)

SLEEVE (1)

SECTION NAME

OUTER MEASURE

DIAMETER

0.288"



LENGTH

2.500"

ASSOCIATED KITS:

PICTURE IS AN APPROXIMATE REPRESENTATION. NOT TO EXACT SCALE OR PROPORTION. ALL MEASUREMENTS IN INCHES. BUSHING DIAMETERS (TOP ROW) ARE OPTIMAL AND SHOULD VARY BY NO MORE THAN .002" WHEN NEW.

ID NUMBER ZTRIMSET02 **TYPE:** TRIMMING SLEEVE
NUMBER OF PARTS 1

NOTES: COMES IN PKTRIMSET FITS INSIDE 1 1/32" TUBES.
ACCEPTS 7MM TRIM SHAFT. NOT AVAILABLE SEPARATELY.

THRU HOLE ACCEPTS 7MM TRIMMER SHAFT

PART NAME
AND ▶
(QUANTITY)
SECTION ▶
NAME

DIAMETER ▶

SLEEVE (1)

OUTER
MEASURE

0.312"



2.500"

LENGTH ▶

**ASSOCIATED
KITS:**

PICTURE IS AN APPROXIMATE REPRESENTATION. NOT TO EXACT SCALE OR PROPORTION. ALL MEASUREMENTS IN INCHES. BUSHING DIAMETERS (TOP ROW) ARE OPTIMAL AND SHOULD VARY BY NO MORE THAN .002" WHEN NEW.

ID NUMBER ZTRIMSET03 **TYPE:** TRIMMING SLEEVE

NOTES: COMES IN PKTRIMSET FITS INSIDE 3/8" TUBES.
ACCEPTS 7MM TRIM SHAFT. NOT AVAILABLE SEPARATELY.

NUMBER OF PARTS 1

THRU HOLE ACCEPTS 7MM TRIMMER SHAFT

PART NAME AND (QUANTITY)

SLEEVE (1)

SECTION NAME

OUTER MEASURE

DIAMETER

0.342"



LENGTH

0.250"

ASSOCIATED KITS:

PICTURE IS AN APPROXIMATE REPRESENTATION. NOT TO EXACT SCALE OR PROPORTION. ALL MEASUREMENTS IN INCHES. BUSHING DIAMETERS (TOP ROW) ARE OPTIMAL AND SHOULD VARY BY NO MORE THAN .002" WHEN NEW.

ID NUMBER ZTRIMSET04 **TYPE:** TRIMMING SLEEVE

NOTES: COMES IN PKTRIMSET FITS INSIDE 10MM AND 25/64" TUBES. ACCEPTS 7MM TRIM SHAFT. NOT AVAILABLE SEPARATELY.

NUMBER OF PARTS 1

THRU HOLE ACCEPTS 7MM TRIMMER SHAFT

PART NAME AND (QUANTITY)

SLEEVE (1)

SECTION NAME

OUTER MEASURE

DIAMETER

0.360"

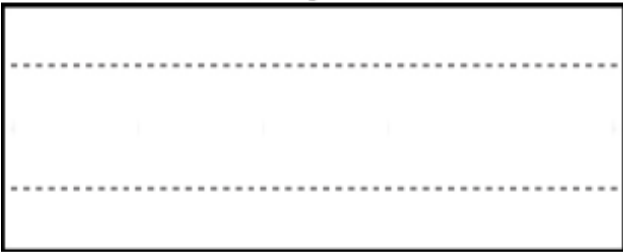

LENGTH

2.500"

ASSOCIATED KITS:

PICTURE IS AN APPROXIMATE REPRESENTATION. NOT TO EXACT SCALE OR PROPORTION. ALL MEASUREMENTS IN INCHES. BUSHING DIAMETERS (TOP ROW) ARE OPTIMAL AND SHOULD VARY BY NO MORE THAN .002" WHEN NEW.

ID NUMBER ZTRIMSET05 **TYPE:** TRIMMING SLEEVE

NOTES: COMES IN PKTRIMSET FITS INSIDE 10.5MM AND 27/64" TUBES. ACCEPTS 7MM TRIM SHAFT. NOT AVAILABLE SEPARATELY.

NUMBER OF PARTS 1

THRU HOLE ACCEPTS 7MM TRIMMER SHAFT

PART NAME AND (QUANTITY)

SLEEVE (1)

SECTION NAME

OUTER MEASURE

DIAMETER

0.377"

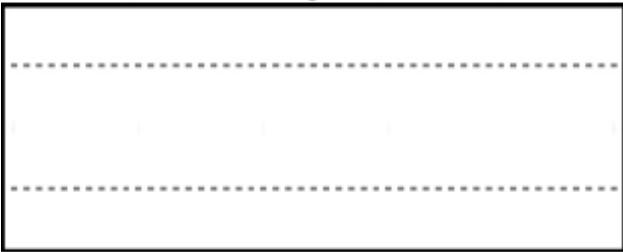

LENGTH

2.500"

ASSOCIATED KITS:

PICTURE IS AN APPROXIMATE REPRESENTATION. NOT TO EXACT SCALE OR PROPORTION. ALL MEASUREMENTS IN INCHES. BUSHING DIAMETERS (TOP ROW) ARE OPTIMAL AND SHOULD VARY BY NO MORE THAN .002" WHEN NEW.

ID NUMBER ZTRIMSET06 **TYPE:** TRIMMING SLEEVE

NOTES: COMES IN PKTRIMSET FITS INSIDE 15/32" TUBES.
ACCEPTS 7MM TRIM SHAFT. NOT AVAILABLE SEPARATELY.

NUMBER OF PARTS 1

THRU HOLE ACCEPTS 7MM TRIMMER SHAFT

**PART NAME
AND** ▶
(QUANTITY)

SLEEVE (1)

SECTION ▶
NAME

OUTER
MEASURE

DIAMETER ▶

0.428"

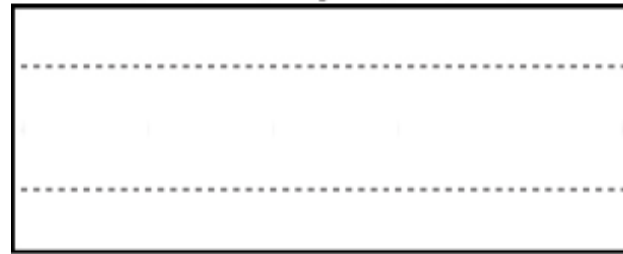

LENGTH ▶

2.500"

**ASSOCIATED
KITS:**

PICTURE IS AN APPROXIMATE REPRESENTATION. NOT TO EXACT SCALE OR PROPORTION. ALL MEASUREMENTS IN INCHES. BUSHING DIAMETERS (TOP ROW) ARE OPTIMAL AND SHOULD VARY BY NO MORE THAN .002" WHEN NEW.

ID NUMBER ZTRIMSET07 **TYPE:** TRIMMING SLEEVE

NOTES: COMES IN PKTRIMSET FITS INSIDE 31/64" AND 12.5MM TUBES. ACCEPTS 7MM TRIM SHAFT. NOT AVAILABLE SEPARATELY.

NUMBER OF PARTS 1

THRU HOLE ACCEPTS 7MM TRIMMER SHAFT

PART NAME AND (QUANTITY)

SECTION NAME

DIAMETER

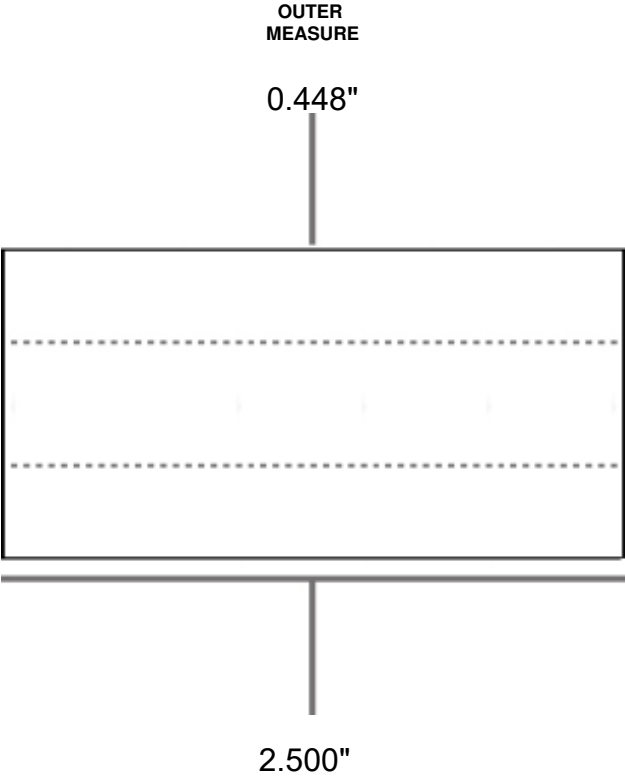

LENGTH

ASSOCIATED KITS:

PICTURE IS AN APPROXIMATE REPRESENTATION. NOT TO EXACT SCALE OR PROPORTION. ALL MEASUREMENTS IN INCHES. BUSHING DIAMETERS (TOP ROW) ARE OPTIMAL AND SHOULD VARY BY NO MORE THAN .002" WHEN NEW.

ID NUMBER ZTRIMSET08 **TYPE:** TRIMMING SLEEVE
NUMBER OF PARTS 1

NOTES: COMES IN PKTRIMSET FITS INSIDE 33/64" TUBES.
ACCEPTS 7MM TRIM SHAFT. NOT AVAILABLE SEPARATELY.

THRU HOLE ACCEPTS 7MM TRIMMER SHAFT

PART NAME
AND ▶
(QUANTITY)
SECTION ▶
NAME

DIAMETER ▶

SLEEVE (1)

OUTER
MEASURE

0.532"

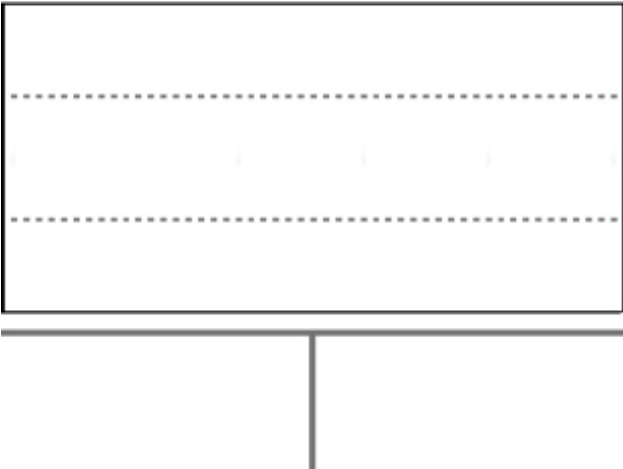

LENGTH ▶

2.500"

ASSOCIATED
KITS:

PICTURE IS AN APPROXIMATE REPRESENTATION. NOT TO EXACT SCALE OR PROPORTION. ALL MEASUREMENTS IN INCHES. BUSHING DIAMETERS (TOP ROW) ARE OPTIMAL AND SHOULD VARY BY NO MORE THAN .002" WHEN NEW.

ID NUMBER ZTRIMSET09 **TYPE:** TRIMMING SLEEVE

NOTES: COMES IN PKTRIMSET FITS INSIDE 9/16" AND 37/64" TUBES. ACCEPTS 7MM TRIM SHAFT. NOT AVAILABLE SEPARATELY.

NUMBER OF PARTS 1

THRU HOLE ACCEPTS 7MM TRIMMER SHAFT

PART NAME AND (QUANTITY)

SLEEVE (1)

SECTION NAME

OUTER MEASURE

DIAMETER

0.532"

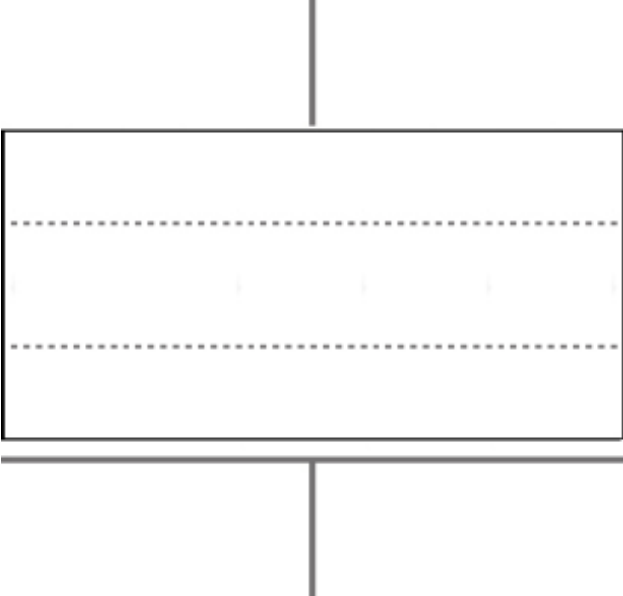

LENGTH

2.500"

ASSOCIATED KITS:

KIT INDEX

ALPHABETIZED BY PRODUCT ID

<u>KIT ID AND DESCRIPTION</u>	<u>BUSHING ID</u>	<u>KIT ID AND DESCRIPTION</u>	<u>BUSHING ID</u>
BS1(XX) - CLASSIC BOTTLE STOPPER.....	PK-BS1-MJ	PK10-RP2(XX) - TRADITIONAL ROLLERBALL.....	PK10-BUSH3
BS10S(XX) - STAINLESS STEEL STOPPER.....	PK-BS1-MJ	PK30M(XX) - 30 CALIBER CARTRIDGE PEN.....	PKM-BUSH3
BS11GS(XX) - GEAR SHIFT BOTTLE STOPPER.....	BS11GSBU	PK4X(XX) - 4 IN 1 MULTIFUNCTION PEN.....	PKVESBU
BS12GA(XX) - SHOTGUN BOTTLE STOPPER.....	BS12GABU	PK50BA(XX) - 50 CAL BOLT ACTION SOLID TIP.....	PK50BABU
BS12S(XX) - TEARDROP STAINLESS STEEL.....	PK-BS1-MJ	PK50BA(XX)2 - 50 CAL BOLT ACTION DIY TIP.....	PK50BABU
BS14S(XX) - CONE STAINLESS STEEL.....	PK-BS1-MJ	PK50BPX(XX) - 50 CALIBER BALLPOINT FLIP.....	PK50RBU
BS15(XX) - POCKET CORKSCREW.....	BS15BU	PK50CAL(XX) - 50 CALIBER MACHINE GUN CARTRIDGE.....	PK50CALBU
BS2(XX) - CHROME AND CORK BOTTLE STOPPER.....	PK-BS1-MJ	PK50CALBS(XX) - CROSS STYLE 50 CAL WITH BOTTLE OPENER.....	PK50CALBU
BS21(XX) - DISC TOP STANDARD CONE BOTTLE STOPPER.....	PKDCMBS	PK50CALP(XX) - 50 CALIBER PARKER STYLE CARTRIDGE.....	PK50CALPBU
BS22(XX) - DISC TOP STANDARD TEARDROP BOTTLE STOPPER.....	PKDCMBS	PK50RBX(XX) - 50 CALIBER ROLLER FLIP.....	PK50RBU
BS23S(XX) - DISC TOP MINI CONE BOTTLE STOPPER.....	PKDCMBS	PKA1(XX) - KNIGHTS ARMOR.....	PKMAJSQBU
BS24S(XX) - DISC TOP MINI TEARDROP BOTTLE STOPPER.....	PKDCMBS	PKAB(XX) - AMERICAN BEAUTY TWIST PEN.....	PKABBU
BS25X(XX) - CHROME CORKSCREW/BOTTLE OPENER.....	BS25XBU	PKANV(XX) - ANVIL EDC KIT.....	PKANVBU
BS27(XX) - 50 CALIBER BOTTLE STOPPER.....	PK-BS1-MJ	PKANVX(XX) - ANVIL PENCIL KIT.....	PKANVBU
BS28(XX) - CORK EXTRACTOR.....	PKBS28CBU	PKAPB(XX) - APOLLO BALLPOINT.....	PKAPBBU
BS3(XX) - ROUND CORKSCREW/ STOPPER.....	PK-BS1-MJ	PKAPCF(XX) - APOLLO FOUNTAIN CLOSED.....	PKAPCEBU
BS5(XX) - SILICONE BOTTLE STOPPER.....	PK-BS1-MJ	PKAPCR(XX) - APOLLO ROLLERBALL CLOSED.....	PKAPCEBU
BS6(XX) - T-HANDLE CORKSCREW.....	BS6-BU	PKAPFIL(XX) - AMERICAN PRIDE FILAGREE TWIST.....	PKAPFILBU
BS7(XX) - T-HANDLE CORKSCREW/STOPPER.....	BS6-BU	PKAPFP2(XX) - APOLLO INFINITY FOUNTAIN PEN.....	PKAPR2BU
BS7LP(XX) - LOW PROFILE STOPPER/CORKSCREW.....	PK-BS1-MJ	PKAPRB2(XX) - APOLLO INFINITY ROLLERBALL.....	PKAPR2BU
BS8(XX) - VINTAGE BOTTLE STOPPER.....	PK-BS1-MJ	PKART(XX)B - ART DECO BALLPOINT.....	PKMAJSQBU
BS9A(XX) - PERFECT SEAL BOTTLE STOPPER.....	PK-BS1-MJ	PKART(XX)F - ART DECO FOUNTAIN.....	PKARTBU
BSLED(XX) - LED BOTTLE STOPPER.....	BSLEDBU	PKART(XX)R - ART DECO ROLLERBALL.....	PKARTBU
BSN-(XX) - RUTH NILES BOTTLESTOPPERS.....	PKBSBU	PKATHN(XX) - AROMATHERAPY NECKLACE.....	PKATHNBU
KSEG(XX) - EGGOSCOPE.....	KSEG-M	PKATHP(XX) - AROMATHERAPY PEN.....	PKPUTBU
KSSP(XX) - STEAMPUNK KALEIDOSCOPE.....	PKSPKSBU	PKATOM(XX) - PERFUME ATOMIZER.....	PKATOM-BU
KSWAND(XX) - WAND KALEIDOSCOPE.....	KSEG-M	PKATOM2(XX) - PURSE STYLE ATOMIZER.....	PKATOM-BU
MCM-CF(XX) - COMFORT PEN NON-PRESS.....	PKM-BUSH3	PKATOMKC(XX) - KEY CHAIN ATOMIZER.....	PKATOMKCBU
MCM-CH(XX) - DIVA CHARM NON-PRESS KIT.....	PKCHPENBU	PKAUTO(XX) - SEMI-AUTO RIFLE PEN.....	PKAUTOBU
MCM-EX(XX) - EXECUTIVE NON-PRESS PEN.....	PKEXEC-BU	PKAUX(XX) - AUX ADAPTER KEYCHAIN.....	PKATHNBU
PHANG2(XX) - HANDY HANDBAG HANGER.....	PKDCM125	PKBASE(XX) - BASEBALL PEN.....	PKBASEBU
PK10-FP2(XX) - TRADITIONAL FOUNTAIN.....	PK10-BUSH3	PKBCM(XX) - BREAST CANCER AWARENESS MINI.....	PKBCMBU

<u>KIT ID AND DESCRIPTION</u>	<u>BUSHING ID</u>
PKBCP(XX) - BREAST CANCER AWARENESS PEN.....	PKBCPBUBU
PKBEGLERI(XX) - BEGLERI KIT.....	PKBEGBUBU
PKBEL(XX) - BELLA TWIST PEN.....	PKBELBUBU
PKBELL(XX) - BRASS DINNER BELL.....	PKM-BUSH3
PKBFPCLCH(XX) - BUFFALO BULLET PENCIL.....	PKEXEC-BU
PKBHOLD(XX) - BRACELET ASSISTANT.....	PKBHOLDBU
PKBIG(XX) - BIG BEN CIGAR TWIST.....	PKBIG-BU
PKBIGC(XX) - BIG BEN CLICK PENCILS.....	PKBIG-BU
PKBIGCP(XX) - BIG BEN CLICK PEN.....	PKBIG-BU
PKBIGFP2(XX) - BIG BEN FOUNTAIN PEN.....	PKBIG-BU
PKBIGRP2(XX) - BIG BEN ROLLERBALL.....	PKBIG-BU
PKBIGST(XX) - BIG BEN STYLUS PEN.....	PKBIG-BU
PKBIGTT(XX) - BIG BEN TWO-TONE CIGAR TWIST.....	PKBIG-BU
PKBIRD(XX) - BIRD PEN.....	PKFEDBUBU
PKBLPEN(XX) - THE BLING.....	PKBCPBUBU
PKBMF(XX) - BALL MARK FIX KIT.....	PKDCM100
PKBPN(XX) - BOTTLE OPENER.....	PKRAHANBU
PKBPNKC(XX) - BOTTLE OPENER KEYCHAIN.....	PKABBU
PKBROCK(XX) - CIGAR PUNCH.....	PKGABU
PKBULPEN(XX) - BULLET MINI PEN.....	PKBULPENBU
PKCAM(XX) - CAMEO TWIST PEN.....	PKCAMBU
PKCAT(XX) - CAT TWIST PEN.....	PKSHAKEBU
PKCCP(XX) - CREDIT CARD PEN.....	PKM-BUSH3
PKCEO(XX) - CEO TWIST PEN.....	PKCEOBU
PKCFUN(XX) - COMFORT FUNLINE PEN.....	PKCFBUSH
PKCFPCL(XX) - COMFORT PENCIL.....	PKCFBUSH
PKCFPEN(XX) - COMFORT PEN.....	PKCFBUSH
PKCHPEN(XX) - DIVA CHARM.....	PKCHPENBU
PKCK(XX) - CHALK HOLDER.....	PKCKBUBU
PKCLBA(XX) - CLIP BOLT ACTION KIT.....	PKCHPENBU
PKCLFP(XX) - CLARION DEMONSTRATOR FOUNTAIN PEN.....	PKCLFPBUBU
PKCLPEN(XX) - CLIP ON PEN.....	PKCLBUBU
PKCMF(XX) - CAMERON FOUNTAIN PEN.....	PKCMRBU
PKCMR(XX) - CAMERON ROLLERBALL.....	PKCMRBU
PKCON(XX) - CONCAVA TWIST PEN.....	PKCONBUBU

<u>KIT ID AND DESCRIPTION</u>	<u>BUSHING ID</u>
PKCORP(XX) - CORTONA STANDARD.....	PKCORBUBU
PKCORS(XX) - CORTANA STYLUS.....	PKCORBUBU
PKCOS(XX) - COSMOPOLITAN TWIST PEN.....	PKCP3000BU
PKCP24(XX) - 30 CALIBER CLICK PEN.....	PKCP2400BU
PKCP25(XX) - 30 CALIBER PENCIL.....	PKCP2400BU
PKCP30(XX) - 30 CALIBER TWIST PEN.....	PKCP3000BU
PKCP35(XX) - 30 CALLIBER LETTER OPENER.....	PKCP3000BU
PKCP36(XX) - 30 CALIBER MAGNIFIER.....	PKCP3000BU
PKCP38(XX) - 30 CALIBER LONGWOOD.....	PKCP3000BU
PKCP60(XX) - OVER & UNDER SHOTGUN.....	PKCP6000BU
PKCP61(XX) - OVER & UNDER FOUNTAIN.....	PKCP6000BU
PKCP70(XX) - MAGNUM BULLET CARTRIDGE.....	PKCP7000BU
PKCP75(XX) - MAGNUM BOLT ACTION BULLET CARTRIDGE.....	PKCP7000BU
PKCP80(XX) - 30 CALIBER BOLT ACTION.....	PKCP3000BU
PKCP81(XX) - BOLT ACTION PENCIL.....	PKCP3000BU
PKCP82(XX) - MINI BOLT ACTON.....	PKCP3000BU
PKCP8AE(XX) - EAGLE BOLT ACTION.....	PKCP3000BU
PKCP8AR(XX) - SALUTE THE TROOPS BOLT ACTION.....	PKCP3000BU
PKCP8DH(XX) - DEER HUNTER BOLT ACTION.....	PKCP3000BU
PKCP8SL(XX) - STATUE OF LIBERTY BOLT ACTION.....	PKCP3000BU
PKCP90(XX) - 30 CALIBER ROLLERBALL.....	PKCP9000BU
PKCPEN(XX) - CELTIC PEN.....	PKGAFBUBU
PKCPENF(XX) - CELTIC FOUNTAIN PEN.....	PKCPENRBU
PKCPENR(XX) - CELTIC ROLLERBALL.....	PKCPENRBU
PKCROCHET(XX) - CROCHET HOOK KIT.....	PKSRBUBU
PKCRONEC(XX) - CROCHET NECKLACE KIT.....	PKSRBUBU
PKCSCOOP(XX) - ONE TABLESPOON COFFEE SCOOP.....	PKCSCOOPBU
PKCSCOOP2(XX) - COFFEE SCOOP 2TBS.....	PKCSCOOPBU
PKCTPEN(XX) - SHIMMERING CRYSTAL PEN.....	PKCTPENBU
PKCWPEN(XX) - CIVIL WAR PEN.....	PKCWPENBU
PKDART1(XX) - STEEL POINT DART.....	PKM-BUSH3
PKDART2(XX) - ELECTRONIC POINT DART.....	PKM-BUSH3
PKDBF(XX) - NOUVEAU SCEPTRE FOUNTAIN.....	PKDBBUBA
PKDBN(XX) - NOUVEAU SCEPTRE BALLPOINT.....	PKMAJSQBU
PKDBR(XX) - NOUVEAU SCEPTRE ROLLER.....	PKDBBUBA

KIT ID AND DESCRIPTION**BUSHING ID**

PKDET2(XX) - DETACHABLE KEY CHAIN BOLT ACTION.....	PKDET2BU
PKDETACH(XX) - DETACHABLE KEY CHAIN.....	PKM-BUSH3
PKDOG(XX) - DOG CLICK.....	PKMAJSQBU
PKDRA(XX) - DRAGON TWIST.....	PKDRABU
PKDRF(XX) - DRAGON FOUNTAIN PEN.....	PKDRRBU
PKDRIP7(XX) - DRIP TIP 7MM.....	PKDRIP7BU
PKDRIP8(XX) - DRIP TIP 8MM.....	PKDRIP8BU
PKDRR(XX) - DRAGON ROLLERBALL.....	PKDRRBU
PKDSTY(XX) - DISC STYLUS PEN.....	PKDSTYBU
PKDU(XX) - DUCHESS.....	PKCFBUSH
PKDUN(XX) - DUCHESS MINI NECKLACE.....	PKCFBUSH
PKDUSLIM(XX) - DURACLICK SLIM KIT.....	PKDUSLIMBU
PKDUX(XX) - DUCHESS MINL.....	PKCFBUSH
PKDVN(XX) - DEVIN CLICK PEN.....	PK10-BUSH3
PKDWE(XX) - CAKE SERVER.....	PKDWBU
PKDWF(XX) - CAKE KNIFE.....	PKDWBU
PKDWG(XX) - CHEESE KNIFE.....	PKDWBU
PKDWH(XX) - CHEESE FORK.....	PKDWBU
PKDWJ(XX) - SERVING SPOON.....	PKDWBU
PKDWK(XX) - SERVING FORK.....	PKDWBU
PKDWL(XX) - PASTA SERVER.....	PKDWBU
PKEDCD(XX) - DURA CLICK EDC PEN.....	PKSPCL3BU
PKEDCDPL(XX) - DURA CLICK EDC PENCIL.....	PKSPCL3BU
PKEDCL(XX) - EVERYDAY CLASSIC.....	PKSPCL3BU
PKEL2F(XX) - CLASSIC ELITE FOUNTAIN.....	PKPAR10-B2
PKEL2R(XX) - CLASSIC ELITE ROLLERBALL.....	PKPAR10-B2
PKELP(XX) - CLASSIC ELITE PETITE FOUNTAIN FLOW.....	PKPAR10-B2
PKEXECF(XX) - EXECUTIVE FOUNTAIN PEN.....	PKEXECRBU
PKEXEC-PCL(XX) - EXECUTIVE PENCIL.....	PKEXEC-BU
PKEXEC-PEN(XX) - EXECUTIVE PEN.....	PKEXEC-BU
PKEXECCR(XX) - EXECUTIVE ROLLERBALL.....	PKEXECCRBU
PKEXECST(XX) - EXECUTIVE STYLUS PEN.....	PKEXEC-BU
PKEZPEN(XX) - E-Z GRIP GELWRITER PEN.....	PKEZBU
PKFAL(XX) - FALCON PEN.....	PKCP3000BU
PKFBALL(XX) - FOOTBALL TWIST PEN.....	PKFBALLBU

KIT ID AND DESCRIPTION**BUSHING ID**

PKFC(XX) - FLASH DRIVE.....	PKFCBU
PKFED(XX) - FEDERAL TWIST PEN.....	PKFEDBU
PKFIL(XX) - FILIGREE PEN.....	PKFILBU
PKFIRE(XX) - FIREMAN PEN.....	PKFIREBU
PKFLIP2(XX) - FLIP STYLUS V2.....	PKFPBU
PKFLY(XX) - FLY FISHING TWIST PEN.....	PKPPENBU
PKFLYF(XX) - FLY FISHING FOUNTAIN.....	PKFLYRBU
PKFLYR(XX) - FLY FISHING ROLLERBALL.....	PKFLYRBU
PKFNEC(XX) - FANCY NECKLACE PEN.....	PKMAGNECUBU
PKFP40(XX) - VERTEX CLICK PEN.....	PKFPBU
PKFP41(XX) - VERTEX PENCIL.....	PKFPBU
PKFP45(XX) - VERTEX BOLT ACTION.....	PKFP4500BU
PKFP50(XX) - MAGNETIC VERTEX ROLLERBALL.....	PKFP5000BU
PKFP51(XX) - MAGNETIC VERTEX FOUNTAIN PEN.....	PKFP5000BU
PKFP55(XX) - VERTEX SUPREME ROLLERBALL.....	PKGRAD2BU
PKFP56(XX) - VERTEX SUPREME FOUNTAIN.....	PKGRAD2BU
PKFPEN(XX) - FILLIBELLE TWIST PEN.....	PKFPENBU
PKGA(XX) - GATSBY TWIST BIMETAL.....	PKGABU
PKGAF(XX) - GATSBY GRANDE.....	PKGAFBU
PKGAM(XX) - WILD CARD TWIST.....	PKVICBU
PKGAPEN(XX) - GATSBY TWIST.....	PKGABU
PKGAPENC(XX) - GATSBY CLICK.....	PKGABU
PKGAPF(XX) - GATSBY FOUNTAIN PEN.....	PKEXECCRBU
PKGAPR(XX) - GATSBY ROLLERBALL.....	PKEXECCRBU
PKGDR(XX) - GUARDIAN JR CLICK PEN.....	PKGDRBU
PKGDPEN(XX) - GUARDIAN CLICK PEN.....	PKGDPENBU
PKGDRB(XX) - GUARDIAN ROLLERBALL.....	PKGDRBBU
PKGEAR(XX) - GEAR SHIFT PEN.....	PKMAJSQBU
PKGOLF(XX) - GOLF PENCIL.....	PKGOLFBU
PKGRAD(XX) - GRADUATE TWIST.....	PKGRADBUBU
PKGRAF(XX) - GRADUATE FOUNTAIN MAGNETIC.....	PKGRAD2BU
PKGRAP(XX) - POST GRADUATE TWIST.....	PKGRAPBU
PKGRAR(XX) - GRADUATE ROLLERBALL MAGNETIC.....	PKGRAD2BU
PKGREN(XX) - GRENADE CLICK PEN.....	PKGRENBU
PKGRIND7(BC)(XX) - 4" LARGE HANDLE SALT & PEPPER GRINDER.....	PKGRIND7BU

KIT ID AND DESCRIPTION**BUSHING ID**

PKGRIND71(XX) - 6" LARGE HANDLE SALT & PEPPER GRINDER.....	PKGRIND7BU
PKGRIND8(XX) - ONE HANDED PRESS TOP PEPPER MILL.....	PKGRIND8BU
PKGRINDPT(XX) - MINI PRESS TOP MILL.....	PKDCMPT
PKGRIUL(XX) - LARGE UPSIDE DOWN PEPPERMILL.....	PKGRIND7BU
PKGTP(XX) - GOTHICA PEN.....	PKVICBU
PKGVCL(XX) - GROOVE CLICK PEN KIT.....	PKM-BUSH3
PKGVTW(XX) - GROOVE TWIST PEN KIT.....	PKM-BUSH3
PKHG(XX) - HOURGLASS PEN.....	PKHGBU
PKHGUN(XX) - SEMI-AUTO PISTOL PEN KIT.....	PKABBU
PKHPEF(XX) - FAITH FOUNTAIN PEN.....	PKHPRBU
PKHPEN(XX) - FAITH TWIST PEN.....	PKHPENBU
PKHPER(XX) - FAITH ROLLERBALL.....	PKHPRBU
PKISCOOP(XX) - ICE CREAM SCOOP.....	PKISCOOPBU
PKJPEN(XX) - COMPSON.....	PKJPENBU
PKKEY(XX) - KEYCHAIN.....	PKM-BUSH3
PKKHANG(XX) - KEYS IN REACH.....	PKDCM100
PKKN(XX) - KNURLED GT PEN.....	PKKNBU
PKKNST(XX) - KNURL GT STYLUS.....	PKKNBU
PKKPCL(XX) - STRATUS CLICK PENCIL.....	PKCHPENBU
PKKPEN(XX) - STRATUS.....	PKCHPENBU
PKL70(XX) - OXFORD TWIST.....	PKJPENBU
PKL75(XX) - OXFORD ROLLERBALL.....	PKL750BU
PKL76(XX) - OXFORD RB V2.....	PKL760BU
PKLEV(XX) - LEVER ACTION RIFLE PEN.....	PKLEVBU
PKLEV(XX)X - LEVER ACTION W/GUNSTOCK.....	PKLEVBU
PKLO(XX) - LETTER OPENER.....	PKM-BUSH3
PKLO2(XX) - DELUXE LETTER OPENER.....	PKMONT-BU
PKLONGPCL(XX) - LONGWOOD PENCIL.....	PKLONGBU
PKLONGPEN(XX) - LONGWOOD PEN.....	PKLONGBU
PKLPULLF(XX) - FANCY LIGHT PULL.....	PKLPULLFBU
PKLSPEN(XX) - LIPSTICK PEN.....	PKLSBU
PK-LTPULL(XX) - LIGHT PULL.....	PKM-BUSH3
PKMAF(XX) - MAJESTIC FOUNTAIN.....	PKMAJBU
PKMAF(XX)JR - MAJESTIC JUNIOR FOUNTAIN.....	PKMAJRBU
PKMAG(XX) - MAGNIFYING GLASS.....	PKM-BUSH3

KIT ID AND DESCRIPTION**BUSHING ID**

PKMAGNEC(XX) - MAGNETIC NECKLACE PEN.....	PKMAGNECBU
PKMAJ(XX) - MAJESTIC ROLLERBALL.....	PKMAJBU
PKMAJ(XX)JR - MAJESTIC JUNIOR ROLLERBALL.....	PKMAJRBU
PKMAJCF(XX) - MAJESTIC JR FOUNTAIN CLOSED.....	PKMJRCBU
PKMAJCR(XX) - MAJESTIC JR CLOSED ROLLERBALL.....	PKMJRCBU
PKMAJLO(XX) - MAJESTIC LETTER OPENER.....	PKMAJLOBU
PKMAJSQ(XX) - MAJESTIC SQUIRE.....	PKMAJSQBU
PKMAY(XX) - MAYAN TWIST.....	PKMAYBU
PKMBX(XX) - PILL BOX.....	PKDCM1916
PKMGH(XX) - MAGNETIC GLASSES HOLDER.....	PKDCMBS
PKMINCLK(XX) - MINI CLICK PEN.....	PKMINCLKBU
PKMINI(XX) - MINI KEY CHAIN PEN.....	PKM-BUSH3
PKMONT(XX) - DESIGNER TENON.....	PKMONT-BU
PKMONT2(XX) - DESIGNER NO TENON.....	PKMONT2-BU
PKMONT2PAR(XX) - PREMIUM DESIGNER NO TENON.....	PKMONTPRBU
PKMONT3(XX) - DESIGNER PENCIL NO TENON.....	PKMONT3BU
PKMONT-BU -	PKMONT-BUX
PKMONT-FP(DD) - DESIGNER FOUNTAIN V1.....	PKMONT3BU
PKMONTLO6(XX) - DESIGNER NT LETTER OPENER.....	PKMONT2-BU
PKMONT-RP(DD) - DESIGNER ROLLERBALL V1.....	PKMONT3BU
PKMONTRP2(XX) - DESIGNER ROLLERBALL.....	PKMONT3BU
PKMOON(XX) - MOON PEN.....	PKMOONBU
PKMOT(XX) - MOTORCYCLE PEN.....	PKPT100BU
PKMPL(XX) - MECHANICAL PENCIL KIT.....	PKFPBU
PKMSCUP(XX) - MEASURING CUP SET.....	PKABBU
PKMSPN(XX) - 4PC MEASURING SPOON SET.....	PKMSPBU
PKMT7(XX) - METALLO 7MM PEN.....	PKMT7BU
PKMTAG(XX) - MONTAGUE TWIST PEN.....	PKGAFBU
PKMTFUN(XX) - DESIGNER FUNLINE.....	PKMONT-BU
PKMTMIN(XX) - DESIGNER MINI.....	PKMONT2-BU
PKMUS(XX) - MUSIC TWIST PEN.....	PKMUSBU
PKMUSF(XX) - MUSIC FOUNTAIN PEN.....	PKMUSRBU
PKMUSR(XX) - MUSIC ROLLERBALL.....	PKMUSRBU
PKNAUT(XX) - NAUTICAL TWIST PEN.....	PKMAJSQBU
PKOL2FP(XX) - OLYMPIAN FOUNTAIN PEN.....	PKOL2BU

<u>KIT ID AND DESCRIPTION</u>	<u>BUSHING ID</u>
PKOL2RB(XX) - OLYMPIAN ROLLERBALL.....	PKOL2BU
PKOLCF(XX) - OLYMPIAN FOUNTAIN CLOSED.....	PKOLCEBU
PKOLCR(XX) - OLYMPIAN CLOSED ROLLERBALL.....	PKOLCEBU
PKORN(XX) - CHRISTMAS TREE ORNAMENT.....	PKM-BUSH3
PKPAR10F(XX) - CLASSIC FOUNTAIN.....	PKPAR10-B2
PKPAR10R(XX) - CLASSIC ROLLERBALL.....	PKPAR10-B2
PKPARK-(XX) - CLASSIC TWIST.....	PKPARK-BU
PKPARK-LO(XX) - CLASSIC LETTER OPENER.....	PKPARK-BU
PKPATDS(XX) - PATRIZIO EUROPEO.....	PKPATDSBU
PKPATPCL(XX) - PATRIZIO PENCIL.....	PKPATPENBU
PKPATPEN(XX) - PATRIZIO TWIST PEN.....	PKPATPENBU
PK-PCL(XX) - SLIMLINE PENCIL.....	PKM-BUSH3
PK-PCLXX(XX) - SLIMLINE PRO PENCIL.....	PK-PENXXBU
PKPCU(XX) - CUE ROLLERBALL KIT.....	PKPCUBU
PK-PEN(XX) - SLIMLINE PEN.....	PKM-BUSH3
PK-PENXX(XX) - SLIMLINE PRO.....	PK-PENXXBU
PKPERF(XX) - PERFUME PEN.....	PKPERF-BU
PKPHANG(XX) - PURSE HANGER.....	PKPHANGM
PKPIR(XX) - PIRATE TWIST PEN.....	PKPIRBU
PKPLI2(XX) - PENLIGHT KEY CHAIN (discontinued).....	PKPLI2-BU
PKPLI3(XX) - LED FLASHLIGHT.....	PKPLI-BU
PKPLIX(XX) - FLASHLIGHT KITS.....	PKPLI-BU
PKPOLICE(XX) - POLICE PEN.....	PKPOLICEBU
PKPOLPCL(XX) - POLARIS PENCIL.....	PK-POLBU
PKPOLPEN(XX) - POLARIS TWIST PEN.....	PK-POLBU
PKPOWPCL(XX) - POWER PENCIL.....	PKPOWBU
PKPOWPEN(XX) - POWER PEN.....	PKPOWBU
PKPPEN(XX) - AMERICAN PATRIOT PEN.....	PKPPENBU
PKPPFP(XX) - PATRIOT FOUNTAIN PEN.....	PKPPRBBU
PKPPRB(XX) - PATRIOT ROLLERBALL PEN.....	PKPPRBBU
PKRPEN(XX) - PRINCESS.....	PKRPENBU
PKPT100F(XX) - PRESIMO FOUNTAIN.....	PKPT100BU
PKPT100R(XX) - PRESIMO ROLLERBALL.....	PKPT100BU
PKPURSE(XX) - MINI PURSE PEN.....	PKPURSEBU
PKPUTCH(XX) - TELESCOPING MAGNETIC PICKUP TOOL.....	PKPUTBU

<u>KIT ID AND DESCRIPTION</u>	<u>BUSHING ID</u>
PKPWMAG(XX) - PAPERWEIGHT MAGNIFIER.....	PKDCM200
PKRABHKIT2(XX) - MONARCH SHAVING BRUSH.....	PKTOOL2BU
PKRAHAN(XX) - MACH3 RAZOR HANDLE.....	PKRAHANBU
PKRAHANMJ(XX) - MAJESTIC RAZOR HANDLE.....	PKMAJSQBU
PKRAHANX(XX) - FUSION RAZOR KIT.....	PKRAHANBU
PKRAMAG(XX) - MAGNUM MACH3 RAZOR HANDLE.....	PKCP7000BU
PKRASAF(XX) - SAFETY RAZOR.....	PKRAHANBU
PKRASAF2(XX) - SPEED DIAL SAFETY RAZOR.....	PKRASAF2BU
PKRASTB(XX) - PREMIUM BRUSH AND RAZOR STAND.....	PKRASTBU
PKRASTE(XX) - CHROME DELUXE RAZOR/ BRUSH STAND.....	PKRASTBU
PKRASTF(XX) - DELUXE SINGLE BATHROOM STAND.....	PKRASTBU
PKRAW(XX) - RAW METAL ROLLERBALL.....	PKMAJSQBU
PKRAWF(XX) - RAW METAL FOUNTAIN PEN.....	PKMAJSQBU
PKRB10(XX) - ROLLESTER.....	PKCHPENBU
PKREV(XX) - REVOLVER CLICK PEN.....	PKREVBUBU
PKRISE(XX) - PHOENIX RISING TWIST PEN.....	PKVICBU
PKRPEN(XX) - SPARTAN.....	PKMAJSQBU
PKRYL(XX) - CROWN JEWEL.....	PKNICK-BU
PKSANDP(XX) - SALT AND PEPPER SHAKERS.....	PKSANDPBU
PKSAPEN(XX) - SHOCK ABSORBER PEN.....	PKSAPENBU
PKSC-LO(XX) - SCULPTURED LETTER OPENER.....	PKSC-BU
PKSC-MAG(XX) - SCULPTURED MAGNIFIER.....	PKSC-BU
PKSC-PEN(XX)V1 - SCULPTURED PEN V1.....	PKSC-BU
PKSC-PEN(XX)V2 - SCULPTURED PEN V2.....	PKSC-BU
PKSCRATCH(XX) - SCRATCH AWL.....	PKM-BUSH3
PKSDPEN(XX) - 3-IN-1 SCREWDRIVER PEN.....	PKSDPENBU
PKSECRET(XX) - SECRET COMPARTMENT KEY CHAIN.....	PK10-BUSH3
PKSEGLO(XX) - SEGMENTED LETTER OPENER.....	PKSEGPENBU
PKSEGMAG(XX) - SEGMENTED MAGNIFIER.....	PKSEGPENBU
PKSEGPEN(XX) - SEGMENTED PEN.....	PKSEGPENBU
PKSEPILL(XX) - SECRET COMPARTMENT PILL BOX.....	PKSEPILLBU
PKSER(XX) - SERPENT PEN.....	PKSERBU
PKSEWHIST(XX) - SECRET COMPARTMENT WHISTLE KEY CHAIN.....	PK10-BUSH3
PKSHA(XX) - SHAKE PEN.....	PKSHAKEBU
PKSKEY(XX) - SKELETON KEY PEN.....	PKGAFBU

<u>KIT ID AND DESCRIPTION</u>	<u>BUSHING ID</u>
PKSKULL(XX) - SKULL TWIST PEN.....	PKSKULLBU
PKSKULLF(XX) - SKULL FOUNTAIN KIT.....	PKSKULLRBU
PKSKULLR(XX) - SKULL ROLLERBALL.....	PKSKULLRBU
PKSLFUN(XX) - FUNLINE PEN.....	PKM-BUSH3
PKSLFUPL(XX) - FUNLINE PENCIL.....	PKM-BUSH3
PKSLX(XX) - CHIC-LINE.....	PKM-BUSH3
PKSLX(XX)2 - CHIC LINE V2.....	PKM-BUSH3
PKSP(XX) - STEAMPUMP KIT.....	PKSPBU
PKSPCL(XX) - WORKSHOP PENCIL.....	PKSPCLBU
PKSPCL2(XX) - DELUX SKETCH PEN/PENCIL.....	PKSPCL2BU
PKSPCL3(XX) - MINI SKETCH PENCIL.....	PKSPCL3BU
PKSPDR(XX) - SPIDER TWIST PEN KIT.....	PKSPDRBU
PKSPEN(XX) - CURVADO.....	PKSPENBU
PKSPP(XX) - STEAMPUNK BOLT ACTION.....	PKVICBU
PKSPRT(XX) - MOBILE DEVICE SUPPORT STYLUS.....	PKSPRTBU
PKSR1(XX) - SEAM RIPPER.....	PKSRBU
PKSR2(XX) - DOUBLE SEAM RIPPER.....	PKSRBU
PKSR3(XX) - STILETTO KIT.....	PKSRBU
PKSR4(XX) - SEAM RIPPER STILLETO COMBO.....	PKSRBU
PKSRN(XX) - SEAM RIPPER NECKLACE.....	PKSRBU
PKSRNT(XX) - NEEDLE THREADER KIT.....	PKSRBU
PKSTANDY(XX) - SINGLE PEN STAND KIT.....	PKSTANDYBU
PKSTPEN(XX) - STARLET STEM PEN.....	PKM-BUSH3
PKSW(XX) - SOUTHWEST TWIST PEN.....	PKSWPBU
PKSWST(XX) - SOUTHWEST MESA TWIST.....	PKCHPENBU
PKSWXR(XX) - SOUTHWEST ROLLERBALL.....	PKMAJRBU
PKTANK(XX) - TANK PEN.....	PKTANKBU
PKTAT(XX) - POTATO MASHER KIT.....	PK-BS1-MJ
PKTBHAN(XX) - TOOTHBRUSH.....	PKRAHANBU
PKTEACH(XX) - TEACHERS PEN.....	PKM-BUSH3
PKTOOL(XX) - MINI KEY CHAIN SCREWDRIVER.....	PK10-BUSH3
PKTOP2(XX) - SPINNING TOP.....	PK10-BUSH3
PKTPC(XX) - MINI TELESCOPING CLIP STYLUS PEN.....	PKM-BUSH3
PKTPEN(XX) - BOLT ACTION TEC-PEN.....	PKTPENBU
PKTPN(XX) - MINI TELESCOPING NECKLACE STYLUS PEN.....	PKM-BUSH3

<u>KIT ID AND DESCRIPTION</u>	<u>BUSHING ID</u>
PKTS1(XX) - KEYCHAIN PEN WITH STYLUS.....	PKTS100BU
PKTS2(XX) - MINI TOUCH STYLUS WITH PLUG.....	PKM-BUSH3
PKTS3(XX) - 3 IN 1 FLIP LED STYLUS PEN.....	PKCKBU
PKTSCP(XX) - MINI TOUCH STYLUS STYLUS PEN.....	PKM-BUSH3
PKTSPEN(XX) - PEN STYLUS.....	PKM-BUSH3
PKTST(XX) - STYLUS.....	PKM-BUSH3
PKTSTEC(XX) - TOUCH STYLUS TEC PEN.....	PKTSTECBU
PKTUD(XX) - TUDOR TWIST PEN.....	PKKNBU
PKTYCF(XX) - CLOSED TYCOON FOUNTAIN.....	PKTYCEBU
PKTYCR(XX) - CLOSED TYCOON ROLLERBALL.....	PKTYCEBU
PKTYFP(XX) - TYCOON FOUNTAIN.....	PKTYBU
PKTYRB(XX) - TYCOON ROLLERBALL.....	PKTYBU
PKVEP(XX) - VESPER STANDARD.....	PKVESBU
PKVES(XX) - VESPER STYLUS.....	PKVESBU
PKVIC(XX) - VICTORIAN TWIST.....	PKVICBU
PKVICFP(XX) - VICTORIAN FOUNTAIN.....	PKVICRBU
PKVICRB(XX) - VICTORIAN ROLLERBALL.....	PKVICRBU
PKVPEN(XX) - APEX SE CLICK PEN.....	PKVPENBU
PKWDYL(XX) - WOODY PENCIL.....	PKWDYBU
PKWDYP(XX) - WOODY PEN.....	PKWDYBU
PKWEST(XX) - COWBOY/WESTERN TWIST PEN.....	PKWESTBU
PK-WHIST(XX) - KEY CHAIN WHISTLE.....	PKATHNBU
PKXM(XX) - TRIMLINE PEN.....	PKXMBU
PKXMPL(XX) - TRIMLINE PENCIL.....	PKXMBU
PKYOGA(XX) - YOGA TWIST PEN.....	PKYOGABU
PKYOYO(XX) - YO YO.....	PK10-BUSH3

BUSHING INDEX

ALPHABETIZED BY BUSHING ITEM NUMBER..
EACH BUSHING IS FOLLOWED BY KITS THAT USE IT.

BS11GSBU	KIT ID# AND DESCRIPTION
	BS11GS(XX) - GEAR SHIFT BOTTLE STOPPER
BS12GABU	KIT ID# AND DESCRIPTION
	BS12GA(XX) - SHOTGUN BOTTLE STOPPER
BS15BU	KIT ID# AND DESCRIPTION
	BS15(XX) - POCKET CORKSCREW
BS25XBU	KIT ID# AND DESCRIPTION
	BS25X(XX) - CHROME CORKSCREW/BOTTLE OPENER
BS6-BU	KIT ID# AND DESCRIPTION
	BS7(XX) - T-HANDLE CORKSCREW/STOPPER BS6(XX) - T-HANDLE CORKSCREW
BSLEDBU	KIT ID# AND DESCRIPTION
	BSLED(XX) - LED BOTTLE STOPPER
KSEG-M	KIT ID# AND DESCRIPTION
	KSWAND(XX) - WAND KALEIDOSCOPE KSEG(XX) - EGGOSCOPE
PK10-BUSH3	KIT ID# AND DESCRIPTION
	PK10-FP2(XX) - TRADITIONAL FOUNTAIN PK10-RP2(XX) - TRADITIONAL ROLLERBALL PKSEWHIST(XX) - SECRET COMPARTMENT WHISTLE KEY CHAIN PKTOP2(XX) - SPINNING TOP PKDVN(XX) - DEVIN CLICK PEN PKSECRET(XX) - SECRET COMPARTMENT KEY CHAIN PKTOOL(XX) - MINI KEY CHAIN SCREWDRIVER PKYOYO(XX) - YO YO
PK50BABU	KIT ID# AND DESCRIPTION
	PK50BA(XX) - 50 CAL BOLT ACTION SOLID TIP PK50BA(XX)2 - 50 CAL BOLT ACTION DIY TIP

PK50CALBU	KIT ID# AND DESCRIPTION
	PK50CALBS(XX) - CROSS STYLE 50 CAL WITH BOTTLE OPENER PK50CAL(XX) - 50 CALIBER MACHINE GUN CARTRIDGE
PK50CALPBU	KIT ID# AND DESCRIPTION
	PK50CALP(XX) - 50 CALIBER PARKER STYLE CARTRIDGE
PK50RBU	KIT ID# AND DESCRIPTION
	PK50BPX(XX) - 50 CALIBER BALLPOINT FLIP PK50RBX(XX) - 50 CALIBER ROLLER FLIP
PKABBU	KIT ID# AND DESCRIPTION
	PKAB(XX) - AMERICAN BEAUTY TWIST PEN PKHGUN(XX) - SEMI-AUTO PISTOL PEN KIT PKMSCUP(XX) - MEASURING CUP SET PKBPNKC(XX) - BOTTLE OPENER KEYCHAIN
PKANVBU	KIT ID# AND DESCRIPTION
	PKANV(XX) - ANVIL EDC KIT PKANVX(XX) - ANVIL PENCIL KIT
PKAPBBU	KIT ID# AND DESCRIPTION
	PKAPB(XX) - APOLLO BALLPOINT
PKAPCEBU	KIT ID# AND DESCRIPTION
	PKAPCF(XX) - APOLLO FOUNTAIN CLOSED PKAPCR(XX) - APOLLO ROLLERBALL CLOSED
PKAPFILBU	KIT ID# AND DESCRIPTION
	PKAPFIL(XX) - AMERICAN PRIDE FILAGREE TWIST
PKAPR2BU	KIT ID# AND DESCRIPTION
	PKAPFP2(XX) - APOLLO INFINITY FOUNTAIN PEN PKAPRB2(XX) - APOLLO INFINITY ROLLERBALL
PKARTBU	KIT ID# AND DESCRIPTION
	PKART(XX)F - ART DECO FOUNTAIN PKART(XX)R - ART DECO ROLLERBALL

PKATHNBU	KIT ID# AND DESCRIPTION
	PK-WHIST(XX) - KEY CHAIN WHISTLE
	PKAUX(XX) - AUX ADAPTER KEYCHAIN
	PKATHN(XX) - AROMATHERAPY NECKLACE
PKATOM-BU	KIT ID# AND DESCRIPTION
	PKATOM2(XX) - PURSE STYLE ATOMIZER
	PKATOM(XX) - PERFUME ATOMIZER
PKATOMKCBU	KIT ID# AND DESCRIPTION
	PKATOMKC(XX) - KEY CHAIN ATOMIZER
PKAUTOBU	KIT ID# AND DESCRIPTION
	PKAUTO(XX) - SEMI-AUTO RIFLE PEN
PKBASEBU	KIT ID# AND DESCRIPTION
	PKBASE(XX) - BASEBALL PEN
PKBCMBU	KIT ID# AND DESCRIPTION
	PKBCM(XX) - BREAST CANCER AWARENESS MINI
PKBCPBU	KIT ID# AND DESCRIPTION
	PKBCP(XX) - BREAST CANCER AWARENESS PEN
	PKBLPEN(XX) - THE BLING
PKBEGBU	KIT ID# AND DESCRIPTION
	PKBEGLERI(XX) - BEGLERI KIT
PKBELBU	KIT ID# AND DESCRIPTION
	PKBEL(XX) - BELLA TWIST PEN
PKBHOLDBU	KIT ID# AND DESCRIPTION
	PKBHOLD(XX) - BRACELET ASSISTANT
PKBIG-BU	KIT ID# AND DESCRIPTION
	PKBIG(XX) - BIG BEN CIGAR TWIST
	PKBIGTT(XX) - BIG BEN TWO-TONE CIGAR TWIST
	PKBIGST(XX) - BIG BEN STYLUS PEN
	PKBIGRP2(XX) - BIG BEN ROLLERBALL
	PKBIGFP2(XX) - BIG BEN FOUNTAIN PEN
	PKBIGC(XX) - BIG BEN CLICK PENCILS
	PKBIGCP(XX) - BIG BEN CLICK PEN

PK-BS1-MJ	KIT ID# AND DESCRIPTION
	BS12S(XX) - TEARDROP STAINLESS STEEL
	BS8(XX) - VINTAGE BOTTLE STOPPER
	BS9A(XX) - PERFECT SEAL BOTTLE STOPPER
	BS7LP(XX) - LOW PROFILE STOPPER/CORKSCREW
	BS1(XX) - CLASSIC BOTTLE STOPPER
	BS10S(XX) - STAINLESS STEEL STOPPER
	BS14S(XX) - CONE STAINLESS STEEL
	BS5(XX) - SILICONE BOTTLE STOPPER
	BS3(XX) - ROUND CORKSCREW/ STOPPER
	BS2(XX) - CHROME AND CORK BOTTLE STOPPER
	BS27(XX) - 50 CALIBER BOTTLE STOPPER
	PKTAT(XX) - POTATO MASHER KIT
PKBS28CBU	KIT ID# AND DESCRIPTION
	BS28(XX) - CORK EXTRACTOR
PKBSBU	KIT ID# AND DESCRIPTION
	BSN-(XX) - RUTH NILES BOTTLESTOPPERS
PKBULPENBU	KIT ID# AND DESCRIPTION
	PKBULPEN(XX) - BULLET MINI PEN
PKCAMBU	KIT ID# AND DESCRIPTION
	PKCAM(XX) - CAMEO TWIST PEN
PKCEOBU	KIT ID# AND DESCRIPTION
	PKCEO(XX) - CEO TWIST PEN
PKCFBUSH	KIT ID# AND DESCRIPTION
	PKCFFUN(XX) - COMFORT FUNLINE PEN
	PKCFPCL(XX) - COMFORT PENCIL
	PKDU(XX) - DUCHESS
	PKCFPEN(XX) - COMFORT PEN
	PKDUX(XX) - DUCHESS MINI
	PKDUN(XX) - DUCHESS MINI NECKLACE
PKCHPENBU	KIT ID# AND DESCRIPTION
	PKCLBA(XX) - CLIP BOLT ACTION KIT

PKCHPENBU	KIT ID# AND DESCRIPTION
	PKCHPEN(XX) - DIVA CHARM
	PKKPEN(XX) - STRATUS
	PKSWST(XX) - SOUTHWEST MESA TWIST
	MCM-CH(XX) - DIVA CHARM NON-PRESS KIT
	PKRB10(XX) - ROLLESTER
	PKKPCL(XX) - STRATUS CLICK PENCIL
PKCKBU	KIT ID# AND DESCRIPTION
	PKCK(XX) - CHALK HOLDER
	PKTS3(XX) - 3 IN 1 FLIP LED STYLUS PEN
PKCLBU	KIT ID# AND DESCRIPTION
	PKCLPEN(XX) - CLIP ON PEN
PKCLFPBU	KIT ID# AND DESCRIPTION
	PKCLFP(XX) - CLARION DEMONSTRATOR FOUNTAIN PEN
PKCMRBU	KIT ID# AND DESCRIPTION
	PKCMR(XX) - CAMERON ROLLERBALL
	PKCMF(XX) - CAMERON FOUNTAIN PEN
PKCONBU	KIT ID# AND DESCRIPTION
	PKCON(XX) - CONCAVA TWIST PEN
PKCORBU	KIT ID# AND DESCRIPTION
	PKCORP(XX) - CORTONA STANDARD
	PKCORS(XX) - CORTANA STYLUS
PKCP2400BU	KIT ID# AND DESCRIPTION
	PKCP24(XX) - 30 CALIBER CLICK PEN
	PKCP25(XX) - 30 CALIBER PENCIL
PKCP3000BU	KIT ID# AND DESCRIPTION
	PKCP36(XX) - 30 CALIBER MAGNIFIER
	PKCP8SL(XX) - STATUE OF LIBERTY BOLT ACTION
	PKCP8DH(XX) - DEER HUNTER BOLT ACTION
	PKCP8AR(XX) - SALUTE THE TROOPS BOLT ACTION
	PKCP8AE(XX) - EAGLE BOLT ACTION
	PKCP82(XX) - MINI BOLT ACTON

PKCP3000BU	KIT ID# AND DESCRIPTION
	PKCP81(XX) - BOLT ACTION PENCIL
	PKCP80(XX) - 30 CALIBER BOLT ACTION
	PKCP38(XX) - 30 CALIBER LONGWOOD
	PKCP35(XX) - 30 CALLIBER LETTER OPENER
	PKCP30(XX) - 30 CALIBER TWIST PEN
	PKCOS(XX) - COSMOPOLITAN TWIST PEN
	PKFAL(XX) - FALCON PEN
PKCP6000BU	KIT ID# AND DESCRIPTION
	PKCP61(XX) - OVER & UNDER FOUNTAIN
	PKCP60(XX) - OVER & UNDER SHOTGUN
PKCP7000BU	KIT ID# AND DESCRIPTION
	PKCP70(XX) - MAGNUM BULLET CARTRIDGE
	PKCP75(XX) - MAGNUM BOLT ACTION BULLET CARTRIDGE
	PKRAMAG(XX) - MAGNUM MACH3 RAZOR HANDLE
PKCP9000BU	KIT ID# AND DESCRIPTION
	PKCP90(XX) - 30 CALIBER ROLLERBALL
PKCPENRBU	KIT ID# AND DESCRIPTION
	PKCPENF(XX) - CELTIC FOUNTAIN PEN
	PKCPENR(XX) - CELTIC ROLLERBALL
PKCSCOOPBU	KIT ID# AND DESCRIPTION
	PKCSCOOP(XX) - ONE TABLESPOON COFFEE SCOOP
	PKCSCOOP2(XX) - COFFEE SCOOP 2TBS
PKCTPENBU	KIT ID# AND DESCRIPTION
	PKCTPEN(XX) - SHIMMERING CRYSTAL PEN
PKCWPENBU	KIT ID# AND DESCRIPTION
	PKCWPEN(XX) - CIVIL WAR PEN
PKDBBUA	KIT ID# AND DESCRIPTION
	PKDBF(XX) - NOUVEAU SCEPTRE FOUNTAIN
	PKDBR(XX) - NOUVEAU SCEPTRE ROLLER
PKDCM100	KIT ID# AND DESCRIPTION
	PKBMF(XX) - BALL MARK FIX KIT

PKDCM100	KIT ID# AND DESCRIPTION PKKHANG(XX) - KEYS IN REACH
PKDCM125	KIT ID# AND DESCRIPTION PHANG2(XX) - HANDY HANDBAG HANGER
PKDCM1916	KIT ID# AND DESCRIPTION PKMBX(XX) - PILL BOX
PKDCM200	KIT ID# AND DESCRIPTION PKPWMAG(XX) - PAPERWEIGHT MAGNIFIER
PKDCMBS	KIT ID# AND DESCRIPTION BS22(XX) - DISC TOP STANDARD TEARDROP BOTTLE STOPPER BS24S(XX) - DISC TOP MINI TEARDROP BOTTLE STOPPER BS21(XX) - DISC TOP STANDARD CONE BOTTLE STOPPER PKMGH(XX) - MAGNETIC GLASSES HOLDER BS23S(XX) - DISC TOP MINI CONE BOTTLE STOPPER
PKDCMPT	KIT ID# AND DESCRIPTION PKGRINDPT(XX) - MINI PRESS TOP MILL
PKDET2BU	KIT ID# AND DESCRIPTION PKDET2(XX) - DETACHABLE KEY CHAIN BOLT ACTION
PKDRABU	KIT ID# AND DESCRIPTION PKDRA(XX) - DRAGON TWIST
PKDRIP7BU	KIT ID# AND DESCRIPTION PKDRIP7(XX) - DRIP TIP 7MM
PKDRIP8BU	KIT ID# AND DESCRIPTION PKDRIP8(XX) - DRIP TIP 8MM
PKDRRBU	KIT ID# AND DESCRIPTION PKDRR(XX) - DRAGON ROLLERBALL PKDRF(XX) - DRAGON FOUNTAIN PEN
PKDSTYBU	KIT ID# AND DESCRIPTION PKDSTY(XX) - DISC STYLUS PEN
PKDUSLIMBU	KIT ID# AND DESCRIPTION PKDUSLIM(XX) - DURACLICK SLIM KIT
PKDWBU	KIT ID# AND DESCRIPTION PKDWF(XX) - CAKE KNIFE

PKDWBU	KIT ID# AND DESCRIPTION PKDWL(XX) - PASTA SERVER PKDWK(XX) - SERVING FORK PKDWG(XX) - CHEESE KNIFE PKDWE(XX) - CAKE SERVER PKDWH(XX) - CHEESE FORK PKDWJ(XX) - SERVING SPOON
PKEXEC-BU	KIT ID# AND DESCRIPTION PKBFPCLCH(XX) - BUFFALO BULLET PENCIL PKEXEC-PCL(XX) - EXECUTIVE PENCIL PKEXEC-PEN(XX) - EXECUTIVE PEN PKEXECST(XX) - EXECUTIVE STYLUS PEN MCM-EX(XX) - EXECUTIVE NON-PRESS PEN
PKEXECRBU	KIT ID# AND DESCRIPTION PKEXECF(XX) - EXECUTIVE FOUNTAIN PEN PKEXECR(XX) - EXECUTIVE ROLLERBALL PKGAPR(XX) - GATSBY ROLLERBALL PKGAPF(XX) - GATSBY FOUNTAIN PEN
PKEZBU	KIT ID# AND DESCRIPTION PKEZPEN(XX) - E-Z GRIP GELWRITER PEN
PKFBALLBU	KIT ID# AND DESCRIPTION PKFBALL(XX) - FOOTBALL TWIST PEN
PKFCBU	KIT ID# AND DESCRIPTION PKFC(XX) - FLASH DRIVE
PKFEDBU	KIT ID# AND DESCRIPTION PKFED(XX) - FEDERAL TWIST PEN PKBIRD(XX) - BIRD PEN
PKFILBU	KIT ID# AND DESCRIPTION PKFIL(XX) - FILIGREE PEN
PKFIREBU	KIT ID# AND DESCRIPTION PKFIRE(XX) - FIREMAN PEN

PKFLYRBU	<i>KIT ID# AND DESCRIPTION</i>
	PKFLYF(XX) - FLY FISHING FOUNTAIN
	PKFLYR(XX) - FLY FISHING ROLLERBALL
PKFP4500BU	<i>KIT ID# AND DESCRIPTION</i>
	PKFP45(XX) - VERTEX BOLT ACTION
PKFP5000BU	<i>KIT ID# AND DESCRIPTION</i>
	PKFP50(XX) - MAGNETIC VERTEX ROLLERBALL
	PKFP51(XX) - MAGNETIC VERTEX FOUNTAIN PEN
PKFPBU	<i>KIT ID# AND DESCRIPTION</i>
	PKFP41(XX) - VERTEX PENCIL
	PKFP40(XX) - VERTEX CLICK PEN
	PKFLIP2(XX) - FLIP STYLUS V2
	PKMPL(XX) - MECHANICAL PENCIL KIT
PKFPENBU	<i>KIT ID# AND DESCRIPTION</i>
	PKFPEN(XX) - FILLIBELLE TWIST PEN
PKGABU	<i>KIT ID# AND DESCRIPTION</i>
	PKBROCK(XX) - CIGAR PUNCH
	PKGA(XX) - GATSBY TWIST BIMETAL
	PKGAPEN(XX) - GATSBY TWIST
	PKGAPENC(XX) - GATSBY CLICK
PKGAFBU	<i>KIT ID# AND DESCRIPTION</i>
	PKSKEY(XX) - SKELETON KEY PEN
	PKCPEN(XX) - CELTIC PEN
	PKMTAG(XX) - MONTAGUE TWIST PEN
	PKGAF(XX) - GATSBY GRANDE
PKGDJRBU	<i>KIT ID# AND DESCRIPTION</i>
	PKGDJR(XX) - GUARDIAN JR CLICK PEN
PKGDPENBU	<i>KIT ID# AND DESCRIPTION</i>
	PKGDPEN(XX) - GUARDIAN CLICK PEN
PKGDRBBU	<i>KIT ID# AND DESCRIPTION</i>
	PKGDRB(XX) - GUARDIAN ROLLERBALL

PKGOLFBU	<i>KIT ID# AND DESCRIPTION</i>
	PKGOLF(XX) - GOLF PENCIL
PKGRAD2BU	<i>KIT ID# AND DESCRIPTION</i>
	PKFP55(XX) - VERTEX SUPREME ROLLERBALL
	PKGRAF(XX) - GRADUATE FOUNTAIN MAGNETIC
	PKFP56(XX) - VERTEX SUPREME FOUNTAIN
	PKGRAR(XX) - GRADUATE ROLLERBALL MAGNETIC
PKGRADBU	<i>KIT ID# AND DESCRIPTION</i>
	PKGRAD(XX) - GRADUATE TWIST
PKGRAPBU	<i>KIT ID# AND DESCRIPTION</i>
	PKGRAP(XX) - POST GRADUATE TWIST
PKGRENBU	<i>KIT ID# AND DESCRIPTION</i>
	PKGREN(XX) - GRENADE CLICK PEN
PKGRIND7BU	<i>KIT ID# AND DESCRIPTION</i>
	PKGRIND71(XX) - 6" LARGE HANDLE SALT & PEPPER GRINDER
	PKGRIND7(BC)(XX) - 4" LARGE HANDLE SALT & PEPPER GRINDER
	PKGRIUL(XX) - LARGE UPSIDE DOWN PEPPERMILL
PKGRIND8BU	<i>KIT ID# AND DESCRIPTION</i>
	PKGRIND8(XX) - ONE HANDED PRESS TOP PEPPER MILL
PKHGBU	<i>KIT ID# AND DESCRIPTION</i>
	PKHG(XX) - HOURGLASS PEN
PKHPENBU	<i>KIT ID# AND DESCRIPTION</i>
	PKHPEN(XX) - FAITH TWIST PEN
PKHPRBU	<i>KIT ID# AND DESCRIPTION</i>
	PKHPEF(XX) - FAITH FOUNTAIN PEN
	PKHPER(XX) - FAITH ROLLERBALL
PKISCOOPBU	<i>KIT ID# AND DESCRIPTION</i>
	PKISCOOP(XX) - ICE CREAM SCOOP
PKJPENBU	<i>KIT ID# AND DESCRIPTION</i>
	PKJPEN(XX) - COMPSON
	PKL70(XX) - OXFORD TWIST
PKKNBU	<i>KIT ID# AND DESCRIPTION</i>
	PKKNST(XX) - KNURL GT STYLUS

PKKNBU	KIT ID# AND DESCRIPTION
	PKKN(XX) - KNURLED GT PEN
	PKTUD(XX) - TUDOR TWIST PEN
PKL750BU	KIT ID# AND DESCRIPTION
	PKL75(XX) - OXFORD ROLLERBALL
PKL760BU	KIT ID# AND DESCRIPTION
	PKL76(XX) - OXFORD RB V2
PKLEVB	KIT ID# AND DESCRIPTION
	PKLEV(XX) - LEVER ACTION RIFLE PEN
	PKLEV(XX)X - LEVER ACTION W/GUNSTOCK
PKLONGBU	KIT ID# AND DESCRIPTION
	PKLONGPEN(XX) - LONGWOOD PEN
	PKLONGPCL(XX) - LONGWOOD PENCIL
PKLPULLFBU	KIT ID# AND DESCRIPTION
	PKLPULLF(XX) - FANCY LIGHT PULL
PKLSBU	KIT ID# AND DESCRIPTION
	PKLSPEN(XX) - LIPSTICK PEN
PKMAGNECBU	KIT ID# AND DESCRIPTION
	PKMAGNEC(XX) - MAGNETIC NECKLACE PEN
	PKFNEC(XX) - FANCY NECKLACE PEN
PKMAJBU	KIT ID# AND DESCRIPTION
	PKMAJ(XX) - MAJESTIC ROLLERBALL
	PKMAF(XX) - MAJESTIC FOUNTAIN
PKMAJJRBU	KIT ID# AND DESCRIPTION
	PKMAJ(XX)JR - MAJESTIC JUNIOR ROLLERBALL
	PKSWXR(XX) - SOUTHWEST ROLLERBALL
	PKMAF(XX)JR - MAJESTIC JUNIOR FOUNTAIN
PKMAJLOBU	KIT ID# AND DESCRIPTION
	PKMAJLO(XX) - MAJESTIC LETTER OPENER
PKMAJSQBU	KIT ID# AND DESCRIPTION
	PKRAWF(XX) - RAW METAL FOUNTAIN PEN
	PKRAW(XX) - RAW METAL ROLLERBALL

PKMAJSQBU	KIT ID# AND DESCRIPTION
	PKDBN(XX) - NOUVEAU SCEPTRE BALLPOINT
	PKRAHANMJ(XX) - MAJESTIC RAZOR HANDLE
	PKMAJSQ(XX) - MAJESTIC SQUIRE
	PKRPEN(XX) - SPARTAN
	PKART(XX)B - ART DECO BALLPOINT
	PKGEAR(XX) - GEAR SHIFT PEN
	PKDOG(XX) - DOG CLICK
	PKA1(XX) - KNIGHTS ARMOR
	PKNAUT(XX) - NAUTICAL TWIST PEN
PKMAYBU	KIT ID# AND DESCRIPTION
	PKMAY(XX) - MAYAN TWIST
PKM-BUSH3	KIT ID# AND DESCRIPTION
	PKSCRATCH(XX) - SCRATCH AWL
	PKDART1(XX) - STEEL POINT DART
	PKDART2(XX) - ELECTRONIC POINT DART
	PKSTPEN(XX) - STARLET STEM PEN
	PKSLX(XX)2 - CHIC LINE V2
	PKCCP(XX) - CREDIT CARD PEN
	PKSLFUPL(XX) - FUNLINE PENCIL
	PKSLFUN(XX) - FUNLINE PEN
	PKORN(XX) - CHRISTMAS TREE ORNAMENT
	PKBELL(XX) - BRASS DINNER BELL
	PKSLX(XX) - CHIC-LINE
	PKTEACH(XX) - TEACHERS PEN
	PKLO(XX) - LETTER OPENER
	PK-LTPULL(XX) - LIGHT PULL
	PKTST(XX) - STYLUS
	PKKEY(XX) - KEYCHAIN
	PKTSPEN(XX) - PEN STYLUS
	PKMAG(XX) - MAGNIFYING GLASS

PKM-BUSH3	KIT ID# AND DESCRIPTION
	PKMINI(XX) - MINI KEY CHAIN PEN
	PKTS2(XX) - MINI TOUCH STYLUS WITH PLUG
	PKDETACH(XX) - DETACHABLE KEY CHAIN
	PK30M(XX) - 30 CALIBER CARTRIDGE PEN
	MCM-CF(XX) - COMFORT PEN NON-PRESS
	PKTPC(XX) - MINI TELESCOPING CLIP STYLUS PEN
	PK-PCL(XX) - SLIMLINE PENCIL
	PK-PEN(XX) - SLIMLINE PEN
	PKTSCCP(XX) - MINI TOUCH STYLUS STYLUS PEN
	PKTPN(XX) - MINI TELESCOPING NECKLACE STYLUS PEN
	PKGVC(XX) - GROOVE CLICK PEN KIT
	PKGVTW(XX) - GROOVE TWIST PEN KIT
PKMINCLKBU	KIT ID# AND DESCRIPTION
	PKMINCLK(XX) - MINI CLICK PEN
PKMJJRCBU	KIT ID# AND DESCRIPTION
	PKMAJCR(XX) - MAJESTIC JR CLOSED ROLLERBALL
	PKMAJCF(XX) - MAJESTIC JR FOUNTAIN CLOSED
PKMONT2-BU	KIT ID# AND DESCRIPTION
	PKMTMIN(XX) - DESIGNER MINI
	PKMONTLO6(XX) - DESIGNER NT LETTER OPENER
	PKMONT2(XX) - DESIGNER NO TENON
PKMONT3BU	KIT ID# AND DESCRIPTION
	PKMONTRP2(XX) - DESIGNER ROLLERBALL
	PKMONT-RP(DD) - DESIGNER ROLLERBALL V1
	PKMONT-FP(DD) - DESIGNER FOUNTAIN V1
	PKMONT3(XX) - DESIGNER PENCIL NO TENON
PKMONT-BU	KIT ID# AND DESCRIPTION
	PKMTFUN(XX) - DESIGNER FUNLINE
	PKLO2(XX) - DELUXE LETTER OPENER
	PKMONT(XX) - DESIGNER TENON

PKMONT-BUX	KIT ID# AND DESCRIPTION
	PKMONT-BU -
PKMONTPRBU	KIT ID# AND DESCRIPTION
	PKMONT2PAR(XX) - PREMIUM DESIGNER NO TENON
PKMOONBU	KIT ID# AND DESCRIPTION
	PKMOON(XX) - MOON PEN
PKMSPBU	KIT ID# AND DESCRIPTION
	PKMSPN(XX) - 4PC MEASURING SPOON SET
PKMT7BU	KIT ID# AND DESCRIPTION
	PKMT7(XX) - METALLO 7MM PEN
PKMUSBU	KIT ID# AND DESCRIPTION
	PKMUS(XX) - MUSIC TWIST PEN
PKMUSRBU	KIT ID# AND DESCRIPTION
	PKMUSF(XX) - MUSIC FOUNTAIN PEN
	PKMUSR(XX) - MUSIC ROLLERBALL
PKNICK-BU	KIT ID# AND DESCRIPTION
	PKRYL(XX) - CROWN JEWEL
PKOL2BU	KIT ID# AND DESCRIPTION
	PKOL2FP(XX) - OLYMPIAN FOUNTAIN PEN
	PKOL2RB(XX) - OLYMPIAN ROLLERBALL
PKOLCEBU	KIT ID# AND DESCRIPTION
	PKOLCF(XX) - OLYMPIAN FOUNTAIN CLOSED
	PKOLCR(XX) - OLYMPIAN CLOSED ROLLERBALL
PKPAR10-B2	KIT ID# AND DESCRIPTION
	PKEL2F(XX) - CLASSIC ELITE FOUNTAIN
	PKPAR10R(XX) - CLASSIC ROLLERBALL
	PKEL2R(XX) - CLASSIC ELITE ROLLERBALL
	PKPAR10F(XX) - CLASSIC FOUNTAIN
	PKELP(XX) - CLASSIC ELITE PETITE FOUNTAIN FLOW
PKPARK-BU	KIT ID# AND DESCRIPTION
	PKPARK-LO(XX) - CLASSIC LETTER OPENER
	PKPARK-(XX) - CLASSIC TWIST

PKPATDSBU	KIT ID# AND DESCRIPTION PKPATDS(XX) - PATRIZIO EUROPEO
PKPATPENBU	KIT ID# AND DESCRIPTION PKPATPCL(XX) - PATRIZIO PENCIL PKPATPEN(XX) - PATRIZIO TWIST PEN
PKPCUBU	KIT ID# AND DESCRIPTION PKPCU(XX) - CUE ROLLERBALL KIT
PK-PENXXBU	KIT ID# AND DESCRIPTION PK-PCLXX(XX) - SLIMLINE PRO PENCIL PK-PENXX(XX) - SLIMLINE PRO
PKPERF-BU	KIT ID# AND DESCRIPTION PKPERF(XX) - PERFUME PEN
PKPHANGM	KIT ID# AND DESCRIPTION PKPHANG(XX) - PURSE HANGER
PKPIRBU	KIT ID# AND DESCRIPTION PKPIR(XX) - PIRATE TWIST PEN
PKPLI2-BU	KIT ID# AND DESCRIPTION PKPLI2(XX) - PENLIGHT KEY CHAIN (discontinued)
PKPLI-BU	KIT ID# AND DESCRIPTION PKPLI3(XX) - LED FLASHLIGHT PKPLIX(XX) - FLASHLIGHT KITS
PK-POLBU	KIT ID# AND DESCRIPTION PKPOLPCL(XX) - POLARIS PENCIL PKPOLPEN(XX) - POLARIS TWIST PEN
PKPOLICEBU	KIT ID# AND DESCRIPTION PKPOLICE(XX) - POLICE PEN
PKPOWBU	KIT ID# AND DESCRIPTION PKPOWPCL(XX) - POWER PENCIL PKPOWPEN(XX) - POWER PEN
PKPPENBU	KIT ID# AND DESCRIPTION PKPPEN(XX) - AMERICAN PATRIOT PEN PKFLY(XX) - FLY FISHING TWIST PEN

PKPPRBBU	KIT ID# AND DESCRIPTION PKPPRB(XX) - PATRIOT ROLLERBALL PEN PKPPFP(XX) - PATRIOT FOUNTAIN PEN
PKPRPENBU	KIT ID# AND DESCRIPTION PKPRPEN(XX) - PRINCESS
PKPT100BU	KIT ID# AND DESCRIPTION PKPT100R(XX) - PRESIMO ROLLERBALL PKPT100F(XX) - PRESIMO FOUNTAIN PKMOT(XX) - MOTORCYCLE PEN
PKPURSEBU	KIT ID# AND DESCRIPTION PKPURSE(XX) - MINI PURSE PEN
PKPUTBU	KIT ID# AND DESCRIPTION PKATHP(XX) - AROMATHERAPY PEN PKPUTCH(XX) - TELESCOPING MAGNETIC PICKUP TOOL
PKRAHANBU	KIT ID# AND DESCRIPTION PKRAHANX(XX) - FUSION RAZOR KIT PKBPN(XX) - BOTTLE OPENER PKRAHAN(XX) - MACH3 RAZOR HANDLE PKRASAF(XX) - SAFETY RAZOR PKTBHAN(XX) - TOOTHBRUSH
PKRASAF2BU	KIT ID# AND DESCRIPTION PKRASAF2(XX) - SPEED DIAL SAFETY RAZOR
PKRASTBU	KIT ID# AND DESCRIPTION PKRASTB(XX) - PREMIUM BRUSH AND RAZOR STAND PKRASTE(XX) - CHROME DELUXE RAZOR/ BRUSH STAND PKRASTF(XX) - DELUXE SINGLE BATHROOM STAND
PKREVB	KIT ID# AND DESCRIPTION PKREV(XX) - REVOLVER CLICK PEN
PKSANDPBU	KIT ID# AND DESCRIPTION PKSANDP(XX) - SALT AND PEPPER SHAKERS
PKSAPENBU	KIT ID# AND DESCRIPTION PKSAPEN(XX) - SHOCK ABSORBER PEN

PKSC-BU	KIT ID# AND DESCRIPTION
	PKSC-PEN(XX)V1 - SCULPTURED PEN V1
	PKSC-MAG(XX) - SCULPTURED MAGNIFIER
	PKSC-LO(XX) - SCULPTURED LETTER OPENER
	PKSC-PEN(XX)V2 - SCULPTURED PEN V2
PKSDPENBU	KIT ID# AND DESCRIPTION
	PKSDPEN(XX) - 3-IN-1 SCREWDRIVER PEN
PKSEGPENBU	KIT ID# AND DESCRIPTION
	PKSEGMAG(XX) - SEGMENTED MAGNIFIER
	PKSEGLO(XX) - SEGMENTED LETTER OPENER
	PKSEGPEN(XX) - SEGMENTED PEN
PKSEPILLBU	KIT ID# AND DESCRIPTION
	PKSEPILL(XX) - SECRET COMPARTMENT PILL BOX
PKSERBU	KIT ID# AND DESCRIPTION
	PKSER(XX) - SERPENT PEN
PKSHAKEBU	KIT ID# AND DESCRIPTION
	PKSHA(XX) - SHAKE PEN
	PKCAT(XX) - CAT TWIST PEN
PKSKULLBU	KIT ID# AND DESCRIPTION
	PKSKULL(XX) - SKULL TWIST PEN
PKSKULLRBU	KIT ID# AND DESCRIPTION
	PKSKULLF(XX) - SKULL FOUNTAIN KIT
	PKSKULLR(XX) - SKULL ROLLERBALL
PKSPBU	KIT ID# AND DESCRIPTION
	PKSP(XX) - STEAMPUMP KIT
PKSPCL2BU	KIT ID# AND DESCRIPTION
	PKSPCL2(XX) - DELUX SKETCH PEN/PENCIL
PKSPCL3BU	KIT ID# AND DESCRIPTION
	PKEDCDPL(XX) - DURA CLICK EDC PENCIL
	PKEDCD(XX) - DURA CLICK EDC PEN
	PKSPCL3(XX) - MINI SKETCH PENCIL
	PKEDCL(XX) - EVERYDAY CLASSIC

PKSPCLBU	KIT ID# AND DESCRIPTION
	PKSPCL(XX) - WORKSHOP PENCIL
PKSPDRBU	KIT ID# AND DESCRIPTION
	PKSPDR(XX) - SPIDER TWIST PEN KIT
PKSPENBU	KIT ID# AND DESCRIPTION
	PKSPEN(XX) - CURVADO
PKSPKSBU	KIT ID# AND DESCRIPTION
	KSSP(XX) - STEAMPUNK KALEIDOSCOPE
PKSPRTBU	KIT ID# AND DESCRIPTION
	PKSPRT(XX) - MOBILE DEVICE SUPPORT STYLUS
PKSRBU	KIT ID# AND DESCRIPTION
	PKCRONEC(XX) - CROCHET NECKLACE KIT
	PKCROCHET(XX) - CROCHET HOOK KIT
	PKSR2(XX) - DOUBLE SEAM RIPPER
	PKSR3(XX) - STILETTO KIT
	PKSR1(XX) - SEAM RIPPER
	PKSR4(XX) - SEAM RIPPER STILLETO COMBO
	PKSRN(XX) - SEAM RIPPER NECKLACE
	PKSRNT(XX) - NEEDLE THREADER KIT
PKSTANDYBU	KIT ID# AND DESCRIPTION
	PKSTANDY(XX) - SINGLE PEN STAND KIT
PKSWPBU	KIT ID# AND DESCRIPTION
	PKSW(XX) - SOUTHWEST TWIST PEN
PKTANKBU	KIT ID# AND DESCRIPTION
	PKTANK(XX) - TANK PEN
PKTOOL2BU	KIT ID# AND DESCRIPTION
	PKRABHKIT2(XX) - MONARCH SHAVING BRUSH
PKTPENBU	KIT ID# AND DESCRIPTION
	PKTPEN(XX) - BOLT ACTION TEC-PEN
PKTS100BU	KIT ID# AND DESCRIPTION
	PKTS1(XX) - KEYCHAIN PEN WITH STYLUS
PKTSTECBU	KIT ID# AND DESCRIPTION
	PKTSTEC(XX) - TOUCH STYLUS TEC PEN

PKTYBU	<i>KIT ID# AND DESCRIPTION</i>
	PKTYRB(XX) - TYCOON ROLLERBALL
	PKTYFP(XX) - TYCOON FOUNTAIN
PKTYCEBU	<i>KIT ID# AND DESCRIPTION</i>
	PKTYCF(XX) - CLOSED TYCOON FOUNTAIN
	PKTYCR(XX) - CLOSED TYCOON ROLLERBALL
PKVESBU	<i>KIT ID# AND DESCRIPTION</i>
	PKVEP(XX) - VESPER STANDARD
	PKVES(XX) - VESPER STYLUS
	PK4X(XX) - 4 IN 1 MULTIFUNCTION PEN
PKVICBU	<i>KIT ID# AND DESCRIPTION</i>
	PKGAM(XX) - WILD CARD TWIST
	PKRISE(XX) - PHOENIX RISING TWIST PEN
	PKSPP(XX) - STEAMPUNK BOLT ACTION
	PKVIC(XX) - VICTORIAN TWIST
	PKGTP(XX) - GOTHICA PEN
PKVICRBU	<i>KIT ID# AND DESCRIPTION</i>
	PKVICFP(XX) - VICTORIAN FOUNTAIN
	PKVICRB(XX) - VICTORIAN ROLLERBALL
PKVPENBU	<i>KIT ID# AND DESCRIPTION</i>
	PKVPEN(XX) - APEX SE CLICK PEN
PKWDYBU	<i>KIT ID# AND DESCRIPTION</i>
	PKWDYL(XX) - WOODY PENCIL
	PKWDYP(XX) - WOODY PEN
PKWESTBU	<i>KIT ID# AND DESCRIPTION</i>
	PKWEST(XX) - COWBOY/WESTERN TWIST PEN
PKXMBU	<i>KIT ID# AND DESCRIPTION</i>
	PKXM(XX) - TRIMLINE PEN
	PKXMPL(XX) - TRIMLINE PENCIL
PKYOGABU	<i>KIT ID# AND DESCRIPTION</i>
	PKYOGA(XX) - YOGA TWIST PEN

DIA.	BUSHING	SECTION	DIA.	BUSHING	SECTION	DIA.	BUSHING	SECTION
0"	PK-BS1-MJ	BASE INTERNAL THREAD 1" X 8TPI	0.287"	PKPOWBU	TIP EXTENSION	0.288"	PKGOLFBU	END BUSHING EXTENSION
0.25"	PKDCMPT	CHUCK MANDREL SHAFT	0.288"	PK50BABU	CENTER TIP BASE EXTENSION	0.288"	PKGRAPBU	CENTER LOWER EXTENSION
0.25"	PKDCMPT	CHUCK MANDREL THREADED SHAFT 1/4X20	0.288"	PK50BABU	TIP EXTENSION	0.288"	PKGRAPBU	TIP EXTENSION
0.274"	PKLONGBU	CENTER BUSHING EXTENSION	0.288"	PK50CALPBU	END EXTENSION	0.288"	PKHGBU	CAP EXTENSION
0.274"	PKMONT3BU	CAP EXTENSION	0.288"	PKANVBU	CAP EXTENSION	0.288"	PKHGBU	TIP EXTENSION
0.274"	PKMONT3BU	CENTER LOWER EXTENSION	0.288"	PKANVBU	TIP EXTENSION	0.288"	PKHPENBU	CAP EXTENSION
0.274"	PKMONT3BU	CENTER UPPER EXTENSION	0.288"	PKAPBBU	CENTERBAND LOWER EXTENSION	0.288"	PKHPENBU	CENTERBAND LOWER EXTENSION
0.274"	PKMONT3BU	TIP EXTENSION	0.288"	PKAPBBU	TIP EXTENSION	0.288"	PKHPENBU	CENTERBAND UPPER EXTENSION
0.28"	PKPERF-BU	CAP/END EXTENSION	0.288"	PKATHNBU	END BUSHING EXTENSION	0.288"	PKHPENBU	TIP EXTENSION
0.28"	PKPERF-BU	CENTER LOWER EXTENSION	0.288"	PKBCPBU	CENTER LOWER EXTENSION	0.288"	PKMONTPRBU	CAP EXTENSION
0.28"	PKPERF-BU	CENTER UPPER EXTENSION	0.288"	PKBCPBU	TIP EXTENSION	0.288"	PKMONTPRBU	CENTER LOWER EXTENSION
0.287"	PKCP2400BU	CAP/TIP EXTENSION	0.288"	PKCAMBU	CENTER LOWER EXTENSION	0.288"	PKMONTPRBU	CENTER UPPER EXTENSION
0.287"	PKMAGNECBU	CENTER LOWER EXTENSION	0.288"	PKCAMBU	TIP EXTENSION	0.288"	PKMONTPRBU	TIP EXTENSION
0.287"	PKMAGNECBU	LOWER CAP EXTENSION	0.288"	PKCORBU	TIP/CAP EXTENSION	0.288"	PKMOONBU	CENTER EXTENSION
0.287"	PKMAYBU	CAP EXTENSION	0.288"	PKCTPENBU	CAP EXTENSION	0.288"	PKMOONBU	TIP EXTENSION
0.287"	PKMAYBU	CENTERBAND LOWER EXTENSION	0.288"	PKCTPENBU	TIP EXTENSION	0.288"	PKMUSBU	CAP EXTENSION
0.287"	PKMAYBU	CENTERBAND UPPER EXTENSION	0.288"	PKDRIP8BU	END BUSHING EXTENSION	0.288"	PKMUSBU	CENTER LOWER EXTENSION
0.287"	PKMAYBU	TIP EXTENSION	0.288"	PKFPENBU	CAP EXTENSION	0.288"	PKMUSBU	CENTER UPPER EXTENSION
0.287"	PKPOWBU	CAP EXTENSION	0.288"	PKFPENBU	CENTER UPPER EXTENSION	0.288"	PKMUSBU	TIP EXTENSION
0.287"	PKPOWBU	CENTER LOWER EXTENSION	0.288"	PKGDRBU	CAP/TIP EXTENSION	0.288"	PKPCUBU	CENTER LOWER EXTENSION
0.287"	PKPOWBU	CENTER UPPER EXTENSION	0.288"	PKGDPENBU	END BUSHINGS EXTENSION	0.288"	PKPCUBU	STYLUS TIP EXTENSION

DIA.	BUSHING	SECTION	DIA.	BUSHING	SECTION	DIA.	BUSHING	SECTION
0.288"	PKPRPENBU	CENTER LOWER EXTENSION	0.288"	PKWESTBU	CENTER LOWER EXTENSION	0.316"	PKCAMBU	TIP BARREL
0.288"	PKPRPENBU	TIP EXTENSION	0.288"	PKWESTBU	CENTER UPPER EXTENSION	0.322"	PKGRADBU	TIP BARREL
0.288"	PKSC-BU	CAP EXTENSION	0.288"	PKWESTBU	TIP EXTENSION	0.33"	PKBCMBU	TIP BARREL
0.288"	PKSC-BU	CENTER LOWER EXTENSION	0.29"	PKEZBU	CAP EXTENSION	0.33"	PKCFBUSH	CAP BARREL
0.288"	PKSC-BU	CENTER UPPER EXTENSION	0.29"	PKEZBU	CENTER LOWER EXTENSION	0.33"	PKCLBU	TIP BARREL
0.288"	PKSC-BU	TIP EXTENSION	0.29"	PKEZBU	CENTER UPPER EXTENSION	0.33"	PKCONBU	TIP BARREL
0.288"	PKSPCL3BU	TOP/BOTTOM EXTENSION	0.29"	PKEZBU	TIP EXTENSION	0.33"	PKLONGBU	TIP BARREL
0.288"	PKSPENBU	CAP / TIP EXTENSION	0.29"	PKPARK-BU	CAP EXTENSION	0.33"	PKVPENBU	TIP BARREL
0.288"	PKSPENBU	CENTER LOWER EXTENSION	0.29"	PKPARK-BU	CENTER LOWER EXTENSION	0.33"	PKXMBU	TIP BARREL
0.288"	PKSPENBU	CENTER UPPER EXTENSION	0.29"	PKPARK-BU	CENTER UPPER EXTENSION	0.333"	PKM-BUSH3	STANDARD BUSHING BARREL
0.288"	PKSRBU	BLADE END EXTENSION	0.29"	PKPARK-BU	TIP EXTENSION	0.335"	PKCEOBU	END BUSHING EXTENSION
0.288"	PKSRBU	CAP END EXTENSION	0.29"	PK-PENXXBU	CAP/TIP EXTENSION	0.34"	PKEXEC-BU	CAP/TIP EXTENSION
0.288"	PKTPENBU	CAP/TIP EXTENSION	0.29"	PK-PENXXBU	CENTERBAND LOWER EXTENSION	0.342"	PKBULPENBU	TIP BARREL
0.288"	PKVPENBU	CAP ASSEMBLY EXTENSION	0.29"	PK-PENXXBU	CENTERBAND UPPER EXTENSION	0.342"	PK-POLBU	CAP EXTENSION
0.288"	PKVPENBU	PLUNGER BOTTOM EXTENSION	0.31"	PKNICK-BU	CAP/TIP EXTENSION	0.342"	PK-POLBU	TIP EXTENSION
0.288"	PKVPENBU	PLUNGER TOP EXTENSION	0.311"	PKDCM1916	MANDREL SHAFT	0.343"	PKBASEBU	CAP EXTENSION
0.288"	PKVPENBU	TIP EXTENSION	0.312"	PKDCM100	MANDREL SHAFT	0.343"	PKBASEBU	TIP EXTENSION
0.288"	PKWDYBU	CAP END EXTENSION	0.312"	PKDCM125	MANDREL SHANK	0.343"	PKCP3000BU	CAP/TIP BUSHING EXTENSION
0.288"	PKWDYBU	TIP EXTENSION	0.312"	PKDCM200	CHUCK MANDREL SHAFT	0.343"	PKCWPENBU	CAP EXTENSION
0.288"	PKWDYBU	TIP EXTENSION	0.312"	PKDCMBS	CHUCK MANDREL SHAFT	0.343"	PKFEDBU	CAP EXTENSION
0.288"	PKWESTBU	CAP EXTENSION	0.312"	PKPHANGM	DRILL CHUCK MANDREL SHAFT	0.343"	PKFEDBU	TIP EXTENSION

DIA.	BUSHING	SECTION	DIA.	BUSHING	SECTION	DIA.	BUSHING	SECTION
0.343"	pkgradbu	CAP EXTENSION	0.344"	PKVICBU	CENTER LOWER EXTENSION	0.345"	PKPPENBU	CENTER LOWER EXTENSION
0.343"	PKGREATBU	CAP EXTENSION	0.344"	PKVICBU	CENTER UPPER EXTENSION	0.345"	PKPPENBU	CENTER UPPER EXTENSION
0.343"	PKGREATBU	CENTER LOWER EXTENSION	0.344"	PKVICBU	TIP/CAP EXTENSION	0.345"	PKPPENBU	TIP/CAP EXTENSION
0.343"	PKGREATBU	CENTER UPPER EXTENSION	0.345"	PK50BABU	BACK END CARTRIDGE BACK EXTENSION	0.345"	PKPURSEBU	CAP EXTENSION
0.343"	PKGREATBU	TIP EXTENSION	0.345"	PK50BABU	CENTER CARTRIDGE FRONT EXTENSION	0.345"	PKPURSEBU	CENTER LOWER EXTENSION
0.343"	PKPIRBU	CENTER LOWER EXTENSION	0.345"	PK50RBU	CAP/TIP EXTENSION	0.345"	PKPURSEBU	CENTER UPPER EXTENSION
0.343"	PKPIRBU	CENTER UPPER EXTENSION	0.345"	PKAPBBU	CAP EXTENSION	0.345"	PKPURSEBU	TIP EXTENSION
0.343"	PKPIRBU	END EXTENSION	0.345"	PKAPBBU	CENTERBAND UPPER EXTENSION	0.345"	PKSKULLBU	CAP/TIP BUSHING EXTENSION
0.343"	PKPOLICEBU	CAP EXTENSION	0.345"	PKBCPBU	CAP EXTENSION	0.345"	PKSKULLBU	CENTERBAND LOWER EXTENSION
0.343"	PKPOLICEBU	TIP EXTENSION	0.345"	PKBCPBU	CENTER UPPER EXTENSION	0.345"	PKSKULLBU	CENTERBAND UPPER EXTENSION
0.343"	PKYOGABU	CAP EXTENSION	0.345"	PKCAMBU	CAP EXTENSION	0.345"	PKSPRTBU	HOLDER END EXTENSION
0.343"	PKYOGABU	CENTER UPPER EXTENSION	0.345"	PKCAMBU	CENTER UPPER EXTENSION	0.345"	PKSPRTBU	STYLUS END EXTENSION
0.343"	PKYOGABU	CENTER UPPER EXTENSION	0.345"	PKCHPENBU	TIP/CAP EXTENSION	0.345"	PKSWPBU	CAP EXTENSION
0.343"	PKYOGABU	TIP EXTENSION	0.345"	PKCWPENBU	TIP EXTENSION	0.345"	PKSWPBU	CAP EXTENSION
0.344"	PKABBU	END EXTENSION	0.345"	PKDRABU	CAP EXTENSION	0.345"	PKSWPBU	CENTER LOWER EXTENSION
0.344"	PKFILBU	CENTER EXTENSION	0.345"	PKDRABU	CENTER LOWER EXTENSION	0.345"	PKSWPBU	CENTER UPPER EXTENSION
0.344"	PKFILBU	TIP EXTENSION	0.345"	PKDRABU	CENTER UPPER EXTENSION	0.345"	PKSWPBU	TIP EXTENSION
0.344"	PKFPBU	CAP/TIP EXTENSION	0.345"	PKDRABU	TIP EXTENSION	0.345"	PKTANKBU	CAP / TIP EXTENSION
0.344"	PKGAFBU	CAP/TIP EXTENSION	0.345"	PKGRADBU	CENTERBAND UPPER EXTENSION	0.347"	PKXMBU	CAP BARREL
0.344"	PKJPENBU	CAP EXTENSION	0.345"	PKKNBU	TIP/CAP EXTENSION	0.35"	PKBCMBU	CENTER LOWER BARREL
0.344"	PKJPENBU	TIP EXTENSION	0.345"	PKMAJSQBU	CAP/TIP EXTENSION	0.35"	PKDUSLIMBU	BUSHING BARREL

DIA.	BUSHING	SECTION	DIA.	BUSHING	SECTION	DIA.	BUSHING	SECTION
0.35"	PKFPENBU	TIP BARREL	0.36"	PK10-BUSH3	CENTER UPPER EXTENSION	0.36"	PKMINCLKBU	CAP EXTENSION
0.35"	PKTSTECBU	TIP BARREL	0.36"	PKAUTOBU	END BUSHING EXTENSION	0.36"	PKMINCLKBU	TIP EXTENSION
0.355"	PKCP7000BU	CAP/TIP EXTENSION	0.36"	PKBELBU	CAP EXTENSION	0.36"	PKMONT-BU	TIP BARREL
0.355"	PKCTPENBU	TIP BARREL	0.36"	PKBELBU	TIP EXTENSION	0.36"	PKMT7BU	END BUSHING BARREL
0.356"	PKGRAPBU	CAP EXTENSION	0.36"	PKBIG-BU	CAP EXTENSION	0.36"	PKPCUBU	CAP EXTENSION
0.356"	PKGRAPBU	CENTER UPPER EXTENSION	0.36"	PKBIG-BU	CENTER LOWER EXTENSION	0.36"	PKPCUBU	CENTER UPPER EXTENSION
0.356"	PKHGBU	TIP BARREL	0.36"	PKBIG-BU	CENTER UPPER EXTENSION	0.36"	PKPRPENBU	CAP EXTENSION
0.356"	PKTYBU	END CAP EXTENSION	0.36"	PKBIG-BU	TIP EXTENSION	0.36"	PKPRPENBU	CENTER UPPER EXTENSION
0.357"	PKL760BU	CAP/TIP EXTENSION	0.36"	PKBULPENBU	CAP BARREL	0.36"	PKPT100BU	TIP/CAP EXTENSION
0.357"	PKMONT2-BU	TIP BARREL	0.36"	PKFBALLBU	CAP EXTENSION	0.36"	PKPUTBU	CENTER LOWER EXTENSION
0.357"	PKTYBU	CENTER LOWER EXTENSION	0.36"	PKFBALLBU	CENTER LOWER EXTENSION	0.36"	PKPUTBU	CENTER UPPER EXTENSION
0.358"	PKMONT3BU	TIP BARREL	0.36"	PKFBALLBU	CENTER UPPER EXTENSION	0.36"	PKPUTBU	END BUSHINGS EXTENSION
0.359"	PKPAR10-B2	CENTER LOWER EXTENSION	0.36"	PKFBALLBU	TIP EXTENSION	0.36"	PKRASAF2BU	TOP/BOTTOM EXTENSION
0.359"	PKPAR10-B2	CENTER UPPER EXTENSION	0.36"	PKFIREBU	CAP EXTENSION	0.36"	PKREVBU	END BUSHING EXTENSION
0.359"	PKPAR10-B2	LOWER CAP EXTENSION	0.36"	PKFIREBU	TIP EXTENSION	0.36"	PKSDPENBU	CAP / CENTER EXTENSION
0.359"	PKPAR10-B2	UPPER CAP EXTENSION	0.36"	PKFP4500BU	END BUSHING EXTENSION	0.36"	PKSPBU	TIP EXTENSION
0.359"	PKSHAKEBU	CENTER BUSHING LOWER EXTENSION	0.36"	PKGRENBU	CAP EXTENSION	0.36"	PKSPBU	UPPER ASSEMBLY EXTENSION
0.359"	PKSHAKEBU	CENTER BUSHING UPPER EXTENSION	0.36"	PKGRENBU	TIP EXTENSION	0.36"	PKVESBU	CAP/TIP EXTENSION
0.359"	PKSHAKEBU	END BUSHING EXTENSION	0.36"	PKGRIND8BU	BODY BUSHING EXTENSION	0.362"	PKCP9000BU	CAP/TIP EXTENSION
0.36"	PK10-BUSH3	CAP/TIP EXTENSION	0.36"	PKLEVBU	CENTER EXTENSION	0.363"	PKL750BU	CAP/TIP EXTENSION
0.36"	PK10-BUSH3	CENTER LOWER EXTENSION	0.36"	PKLEVBU	TIP EXTENSION	0.366"	PKWDYBU	TIP TIP DIAMETER

DIA.	BUSHING	SECTION	DIA.	BUSHING	SECTION	DIA.	BUSHING	SECTION
0.367"	PKGOLFBU	END BUSHING BARREL	0.375"	PKMUSRBU	CENTER LOWER EXTENSION	0.376"	PKMAJRBUB	CENTER LOWER EXTENSION
0.368"	PK50BABU	TIP BARREL	0.375"	PKMUSRBU	LOWER CAP EXTENSION	0.376"	PKMAJRBUB	END CAP EXTENSION
0.368"	PK50CALPBU	END BARREL	0.375"	PKPATDSBU	TIP BARREL	0.376"	PKMJRCBU	LOWER BARREL BUSHING EXTENSION
0.369"	PK50CALBU	TIP BARREL	0.375"	PKSERBU	CAP EXTENSION	0.376"	PKOLCEBU	LOWER BARREL BUSHING EXTENSION
0.369"	PKMONTPRBU	TIP BARREL	0.375"	PKSERBU	CENTER LOWER EXTENSION	0.376"	PKPPRBUB	CAP EXTENSION
0.37"	PKCLBU	CAP BARREL	0.375"	PKSERBU	CENTER UPPER EXTENSION	0.376"	PKPPRBUB	CENTER LOWER EXTENSION
0.37"	PKPOWBU	TIP BARREL	0.375"	PKSERBU	TIP EXTENSION	0.376"	PKPPRBUB	CENTER UPPER EXTENSION
0.373"	PKATHNBU	END BUSHING BARREL	0.375"	PKSKULLRBU	CENTER LOWER EXTENSION	0.376"	PKPPRBUB	LOWER CAP EXTENSION
0.373"	PKSPCLBU	CENTER LOWER EXTENSION	0.375"	PKSKULLRBU	LOWER EXTENSION	0.376"	PKTYCEBU	LOWER BARREL BUSHING EXTENSION
0.373"	PKSPCLBU	CENTER UPPER EXTENSION	0.375"	PKSPDRBU	END BUSHING EXTENSION	0.377"	PKAPFILBU	CAP EXTENSION
0.374"	PKSPCL2BU	CAP EXTENSION	0.375"	PKSRBU	CAP END BARREL	0.377"	PKAPFILBU	CENTER LOWER EXTENSION
0.374"	PKSPCL2BU	TIP EXTENSION	0.375"	PKVICRBU	CENTER LOWER EXTENSION	0.377"	PKAPFILBU	CENTER UPPER EXTENSION
0.374"	PKSPCLBU	TIP/CAP EXTENSION	0.375"	PKVICRBU	LOWER CAP EXTENSION	0.377"	PKAPFILBU	TIP EXTENSION
0.375"	PK-BS1-MJ	POST 3/8 X 16TPI SCREW	0.376"	PKAPCEBU	LOWER BLANK EXTENSION	0.377"	PKARTBU	CENTER LOWER EXTENSION
0.375"	PKCMRBU	CENTER LOWER EXTENSION	0.376"	PKDBBUA	CENTER LOWER EXTENSION	0.377"	PKARTBU	LOWER CAP EXTENSION
0.375"	PKCMRBU	LOWER CAP EXTENSION	0.376"	PKDBBUA	END CAP EXTENSION	0.377"	PKCPENRBU	CENTER LOWER EXTENSION
0.375"	PKCPENRBU	LOWER CAP EXTENSION	0.376"	PKDRRBU	CENTER LOWER EXTENSION	0.377"	PKEXECRBU	CENTER LOWER EXTENSION
0.375"	PKDET2BU	SWIVEL SIDE BUSHING BARREL	0.376"	PKDRRBU	TIP END EXTENSION	0.377"	PKEXECRBU	LOWER END EXTENSION
0.375"	PKFLYRBU	CENTER LOWER EXTENSION	0.376"	PKFP5000BU	TIP/ENDCAP EXTENSION	0.377"	PKGRAD2BU	CENTER LOWER EXTENSION
0.375"	PKFLYRBU	LOWER END EXTENSION	0.376"	PKHPRBU	CENTER LOWER EXTENSION	0.377"	PKGRAD2BU	LOWER CAP EXTENSION
0.375"	PKMAGNECBU	LOWER CAP BARREL	0.376"	PKHPRBU	LOWER CAP EXTENSION	0.38"	PKDET2BU	CLIP SIDE BUSHING BARREL

DIA.	BUSHING	SECTION	DIA.	BUSHING	SECTION	DIA.	BUSHING	SECTION
0.38"	PKPCUBU	STYLUS TIP BARREL	0.4"	PKMONT3BU	CAP BARREL	0.42"	PKCLBU	CENTER BARREL
0.38"	PKTS100BU	STYLUS END BARREL	0.4"	PKMONT3BU	CENTER LOWER BARREL	0.42"	PKDSTYBU	CENTER/END BARREL
0.382"	PKBCPBU	TIP BARREL	0.4"	PKPARK-BU	CENTER LOWER BARREL	0.42"	PKEEXEC-BU	CAP/TIP BARREL
0.384"	PKGABU	CAP/TIP BUSHING EXTENSION	0.4"	PKPARK-BU	TIP BARREL	0.42"	PKLONGBU	CAP BARREL
0.387"	PKPRPENBU	TIP BARREL	0.4"	PKRAHANBU	CAP/TIP BARREL	0.42"	PKLONGBU	CENTER BUSHING BARREL
0.388"	PKSAPENBU	CAP EXTENSION	0.4"	PKSPENBU	CAP / TIP BARREL	0.42"	PKMONT2-BU	CENTER LOWER BARREL
0.388"	PKSAPENBU	CENTER EXTENSION	0.401"	PKMONT-BUX	CENTER BUSHING TENON SIZER	0.42"	PKNICK-BU	CAP/TIP BARREL
0.389"	BS25XBU	END BUSHING HANDLE BARREL	0.402"	PKAPBBU	TIP BARREL	0.42"	PKPATPENBU	TIP BARREL
0.389"	PKPERF-BU	CAP/END BARREL	0.404"	PKVPENBU	PLUNGER TOP BARREL	0.422"	PKAPBBU	CENTERBAND LOWER BARREL
0.389"	PKPERF-BU	CENTER BARREL	0.405"	PKMONT-BU	CENTER TENON / LOWER BARREL	0.425"	PKCEOBU	END BUSHING BARREL
0.39"	BS6-BU	END TIP BARREL	0.407"	PKBCMBU	CAP BARREL	0.425"	PKEZBU	CAP BARREL
0.392"	PKGDRBBU	CENTER LOWER EXTENSION	0.407"	PKMONT2-BU	CAP BARREL	0.425"	PKEZBU	CENTER BARREL
0.392"	PKGDRBBU	END CAP EXTENSION	0.407"	PKMONT-BU	CAP BARREL	0.425"	PKEZBU	TIP BARREL
0.393"	PKANVBU	TIP BARREL	0.408"	PKBCPBU	CAP BARREL	0.425"	PKMONTPRBU	CENTER LOWER BARREL
0.393"	PKDRIP7BU	END BUSHINGS BARREL	0.41"	PKANVBU	CAP BARREL	0.425"	PK-PENXXBU	CAP/TIP BARREL
0.393"	PKMAGNECBU	CENTER UPPER EXTENSION	0.41"	PKFPENBU	CAP BARREL	0.425"	PK-PENXXBU	CENTERBAND BARREL
0.393"	PKMAGNECBU	UPPER CAP EXTENSION	0.41"	PKSEGPENBU	CAP/TIP BARREL	0.425"	PKPURSEBU	CAP BARREL
0.393"	PKSC-BU	CENTER LOWER BARREL	0.415"	PKMONTPRBU	CAP BARREL	0.425"	PKPURSEBU	TIP BARREL
0.393"	PKSC-BU	TIP BARREL	0.417"	PKCORBU	TIP/CAP BARREL	0.425"	PKTPENBU	CAP/TIP BARREL
0.394"	PKVPENBU	PLUNGER BOTTOM BARREL	0.417"	PKMONT-BUX	CENTER BUSHING LOWER TUBE	0.425"	PKYOGABU	TIP BARREL
0.398"	PKCTPENBU	CAP BARREL	0.42"	PKCFBUSH	TIP/CENTER BARREL	0.426"	PKMONT-BU	CENTER UPPER BARREL

DIA.	BUSHING	SECTION	DIA.	BUSHING	SECTION	DIA.	BUSHING	SECTION
0.427"	PKMAJBU	CENTER LOWER EXTENSION	0.433"	PKGRABDU	CENTERBAND LOWER BARREL	0.45"	PK10-BUSH3	CAP/TIP BARREL
0.427"	PKMAJBU	END CAP EXTENSION	0.434"	pkgradbu	CAP BARREL	0.45"	PK10-BUSH3	CENTER BARREL
0.428"	BS15BU	END CAP EXTENSION	0.435"	PKDWBU	DINING BUSHING BARREL	0.45"	PKCONBU	CENTERBAND LOWER BARREL
0.428"	BS15BU	UPPER EXTENSION	0.435"	PKSPCL3BU	TOP/BOTTOM BARREL	0.45"	PKCP6000BU	CENTER LOWER EXTENSION
0.428"	BS25XBU	END BUSHING OPENER EXTENSION	0.436"	PKTSTECBU	CENTER BARREL	0.45"	PKCP6000BU	END CAP EXTENSION
0.428"	BSLEDBU	BUTTON END EXTENSION	0.44"	PKBHOLDBU	END BUSHINGS BARREL	0.45"	PKPATDSBU	CAP BARREL
0.428"	BSLEDBU	STOPPER END EXTENSION	0.44"	PKJPENBU	CAP BARREL	0.45"	PK-POLBU	TIP BARREL
0.428"	PKTSTECBU	CAP BARREL	0.44"	PKMSPBU	CAP SIDE BARREL	0.45"	PKSHAKEBU	END BUSHING BARREL
0.428"	PKTYBU	CENTER UPPER EXTENSION	0.44"	PKPATDSBU	CENTER LOWER BARREL	0.451"	PKBASEBU	TIP BARREL
0.428"	PKTYBU	CLIP ASSEMBLY EXTENSION	0.44"	PKPATPENBU	CAP BARREL	0.451"	PKPLI-BU	CAP/TIP EXTENSION
0.429"	PKFEDBU	TIP BARREL	0.44"	PKPOLICEBU	TIP BARREL	0.451"	PKPLI-BU	CENTER LOWER EXTENSION
0.429"	PKMOONBU	TIP BARREL	0.44"	PKXMBU	CENTER BARREL	0.451"	PKPLI-BU	CENTER UPPER EXTENSION
0.43"	PKSCCOOPBU	STEP BUSHING TENON	0.442"	PKRPRBU	CENTER LOWER BARREL	0.452"	PKAPR2BU	CENTER LOWER EXTENSION
0.43"	PKPOWBU	CAP BARREL	0.443"	PKCAMBU	CENTER UPPER BARREL	0.452"	PKAPR2BU	END CAP EXTENSION
0.43"	PKPOWBU	CENTER BARREL	0.443"	PKPAR10-B2	CENTER LOWER BARREL	0.455"	PKATOMKCBU	BARREL TRIMMER SLEEVE OUTER DIAMETER
0.43"	PKPURSEBU	CENTER BARREL	0.443"	PKPAR10-B2	LOWER CAP BARREL	0.455"	PKFILBU	TIP BARREL
0.43"	PKSRBU	BLADE END BARREL	0.445"	PKBCPBU	CENTER LOWER BARREL	0.455"	PKMOONBU	CENTER BARREL
0.431"	PKHPENBU	TIP BARREL	0.445"	PKCHPENBU	TIP/CAP BARREL	0.456"	PKJPENBU	TIP BARREL
0.432"	PKISCOOPBU	HANDLE BUSHING TRIMMING EXTENSION	0.446"	PKOL2BU	CENTER LOWER EXTENSION	0.456"	PKSPRTBU	STYLUS END BARREL
0.432"	PKISCOOPBU	HANDLE BUSHING TURNING EXTENSION	0.446"	PKOL2BU	ENDCAP EXTENSION	0.457"	PKABBU	END BARREL
0.433"	PKFPBU	CAP/TIP BARREL	0.446"	PKYOGABU	CAP BARREL	0.457"	PKCPENRBU	CAP EXTENSION

DIA.	BUSHING	SECTION	DIA.	BUSHING	SECTION	DIA.	BUSHING	SECTION
0.458"	PKARTBU	CAP EXTENSION	0.458"	PKVICRBU	UPPER CAP EXTENSION	0.466"	PKCP2400BU	CAP/TIP BARREL
0.458"	PKARTBU	CENTER UPPER EXTENSION	0.459"	PKDBBUA	CENTER UPPER EXTENSION	0.466"	PKCP3000BU	CAP/TIP BUSHING BARREL
0.458"	PKCKBU	END BUSHING EXTENSION	0.459"	PKDBBUA	CLIP ASSEMBLY EXTENSION	0.466"	PKMINCLKBU	CAP BARREL
0.458"	PKCPENRBU	CENTER UPPER EXTENSION	0.459"	PKFP5000BU	TIP/ENDCAP BARREL	0.466"	PKMINCLKBU	TIP BARREL
0.458"	PKDRRBU	CENTER UPPER EXTENSION	0.459"	PKVICRBU	CENTER UPPER EXTENSION	0.467"	PKGREATBU	TIP BARREL
0.458"	PKDRRBU	UPPER END EXTENSION	0.46"	KSNECBU	END BUSHING EXTENSION	0.468"	PKFIREBU	TIP BARREL
0.458"	PKEXECRBU	CAP EXTENSION	0.46"	PKBIG-BU	TIP BARREL	0.468"	PKPCUBU	CAP BARREL
0.458"	PKEXECRBU	CENTER UPPER EXTENSION	0.46"	PKCLFPBU	END BUSHING EXTENSION	0.469"	PKBELBU	TIP BARREL
0.458"	PKGRAD2BU	CAP EXTENSION	0.46"	PKCMRBU	CAP EXTENSION	0.469"	PKYOGABU	CENTER UPPER BARREL
0.458"	PKGRAD2BU	CENTER UPPER EXTENSION	0.46"	PKCMRBU	CENTER UPPER EXTENSION	0.47"	PKGABU	CAP/TIP BUSHING BARREL
0.458"	PKHPRBU	CAP EXTENSION	0.46"	PKFLYRBU	CAP EXTENSION	0.47"	PKPATPENBU	CENTER BARREL
0.458"	PKHPRBU	CENTER UPPER EXTENSION	0.46"	PKFLYRBU	CENTER UPPER EXTENSION	0.47"	PKPPRBBU	CAP BARREL
0.458"	PKLSBU	CENTERBAND LOWER EXTENSION	0.46"	PKLSBU	SLEEVE OUTER DIAMETER	0.471"	PKSPBU	TIP BARREL
0.458"	PKLSBU	CENTERBAND UPPER EXTENSION	0.46"	PKMSPBU	SPOON SIDE BARREL	0.472"	PKAPFILBU	CENTER LOWER BARREL
0.458"	PKLSBU	END BUSHING EXTENSION	0.46"	PKMUSRBU	CAP/CLIP EXTENSION	0.472"	PKAPFILBU	TIP BARREL
0.458"	PKMAJRBUBU	CENTER UPPER EXTENSION	0.46"	PKMUSRBU	CENTER UPPER EXTENSION	0.472"	PKKNBU	TIP/CAP BARREL
0.458"	PKMAJRBUBU	CLIP ASSEMBLY EXTENSION	0.46"	PKSEGPENBU	CENTER/COUPLER BARREL	0.474"	PKVESBU	CAP/TIP BARREL
0.458"	PKMAJLOBU	END BUSHING EXTENSION	0.46"	PKSKULLRBU	CENTER UPPER EXTENSION	0.474"	PKYOGABU	CENTER LOWER BARREL
0.458"	PKMJJRBU	UPPER BARREL BUSHING EXTENSION	0.46"	PKSKULLRBU	UPPER EXTENSION	0.475"	PKBELBU	CAP BARREL
0.458"	PKOLCEBU	UPPER BARREL BUSHING EXTENSION	0.462"	PKATOMKCBU	END BUSHING EXTENSION	0.475"	PKGRAPBU	CENTER LOWER BARREL
0.458"	PKTYCEBU	UPPER BARREL BUSHING EXTENSION	0.466"	PKBCMBU	CENTER UPPER BARREL	0.475"	PKGRAPBU	TIP BARREL

DIA.	BUSHING	SECTION	DIA.	BUSHING	SECTION	DIA.	BUSHING	SECTION
0.475"	PKL750BU	CAP/TIP BARREL	0.484"	PKLEVBU	TIP BARREL	0.495"	PKAPFILBU	CENTER UPPER BARREL
0.475"	PKSDPENBU	CAP / CENTER BARREL	0.485"	PKCWPENBU	TIP BARREL	0.495"	PKCMRBU	LOWER CAP BARREL
0.475"	PKSDPENBU	TIP BARREL	0.485"	PKLPULLFBU	END BUSHING BARREL	0.495"	PKMAJSQBU	CAP/TIP BARREL
0.476"	PKBIG-BU	CAP BARREL	0.486"	PKFBALLBU	TIP BARREL	0.495"	PKPAR10-B2	CENTER UPPER BARREL
0.477"	PKCP9000BU	CAP/TIP BARREL	0.486"	PKPCUBU	CENTER LOWER BARREL	0.495"	PKPIRBU	END BARREL
0.478"	PKCAMBU	CENTER LOWER BARREL	0.487"	PKGREATBU	CENTER BARREL	0.495"	PK-POLBU	CAP BARREL
0.478"	PKL760BU	CAP/TIP BARREL	0.488"	PKPUTBU	CENTER BARREL	0.498"	PKSHAKEBU	CENTER BUSHING BARREL
0.48"	PKEXECRBU	CENTER LOWER BARREL	0.488"	PKPUTBU	END BUSHINGS BARREL	0.5"	BSLEDBU	BUTTON END BARREL
0.48"	PKEXECRBU	LOWER END BARREL	0.49"	PKBHOLDBU	CENTER BUSHING BARREL	0.5"	PKHPENBU	CENTERBAND BARREL
0.48"	PKGRIND8BU	BODY BUSHING BARREL	0.49"	PKFIREBU	CAP BARREL	0.5"	PKLEVBU	CENTER BARREL
0.48"	PKHGBU	CAP BARREL	0.49"	PKPARK-BU	CAP BARREL	0.5"	PKMAGNECBU	CENTER LOWER BARREL
0.48"	PKPATDSBU	CENTER UPPER BARREL	0.49"	PKPARK-BU	CENTER UPPER BARREL	0.5"	PKPCUBU	CENTER UPPER BARREL
0.48"	PKPPENBU	CENTER BARREL	0.49"	PKPRPENBU	CAP BARREL	0.5"	PKPPRBBU	CENTER LOWER BARREL
0.48"	PKPPENBU	TIP/CAP BARREL	0.491"	PKOL2BU	CENTER UPPER EXTENSION	0.5"	PKPPRBBU	LOWER CAP BARREL
0.48"	PKSC-BU	CAP BARREL	0.491"	PKOL2BU	CLIP ASSEMBLY EXTENSION	0.5"	PKPT100BU	TIP/CAP BARREL
0.48"	PKSC-BU	CENTER UPPER BARREL	0.492"	PKPAR10-B2	UPPER CAP BARREL	0.5"	PKSAPENBU	CAP BARREL
0.48"	PKSWPBU	CENTER UPPER BARREL	0.492"	PKPRPENBU	CENTER UPPER BARREL	0.5"	PKSPBU	UPPER ASSEMBLY BARREL
0.48"	PKTYBU	END CAP BARREL	0.492"	PKSERBU	TIP BARREL	0.5"	PKSPCL2BU	TIP BARREL
0.48"	PKTYCEBU	LOWER BARREL BUSHING BARREL	0.493"	PKDRIP8BU	END BUSHING BARREL	0.5"	PKSWPBU	CENTER LOWER BARREL
0.481"	PKTYBU	CENTER LOWER BARREL	0.494"	PKFP4500BU	END BUSHING BARREL	0.5"	PKSWPBU	TIP BARREL
0.483"	PKFEDBU	CAP BARREL	0.495"	PKAPFILBU	CAP BARREL	0.502"	PKFBALLBU	CENTER BARREL

DIA.	BUSHING	SECTION	DIA.	BUSHING	SECTION	DIA.	BUSHING	SECTION
0.505"	PK50RBU	CAP/TIP BARREL	0.515"	PKBASEBU	CAP BARREL	0.52"	PKCONBU	CENTERBAND UPPER BARREL
0.506"	PKAUTOBU	END BUSHING BARREL	0.515"	PKCPENRBU	CENTER LOWER BARREL	0.52"	PKHPRBU	CENTER LOWER BARREL
0.507"	PKWESTBU	TIP BARREL	0.515"	PKCPENRBU	LOWER CAP BARREL	0.52"	PKHPRBU	LOWER CAP BARREL
0.508"	PKGREATBU	CAP BARREL	0.515"	PKFBALLBU	CAP BARREL	0.521"	PKSEPILLBU	END BUSHING EXTENSION
0.508"	PKREVBUB	END BUSHING BARREL	0.515"	PKGRAPBU	CAP BARREL	0.522"	PKMONT2-BU	CENTER UPPER BARREL
0.508"	PKWESTBU	CENTER BARREL	0.515"	PKGRAPBU	CENTER UPPER BARREL	0.522"	PKMONT3BU	CENTER UPPER BARREL
0.51"	BS15BU	END CAP BARREL	0.515"	PKMAYBU	CENTERBAND BARREL	0.522"	PKMONTPRBU	CENTER UPPER BARREL
0.51"	PKPPRBBU	CENTER UPPER BARREL	0.515"	PKMAYBU	TIP BARREL	0.525"	PKCP7000BU	CAP/TIP BARREL
0.51"	PKSPCLBU	CENTER BARREL	0.516"	PKGRAD2BU	CENTER LOWER BARREL	0.525"	PKGAFBU	CAP/TIP BARREL
0.51"	PKSPCLBU	TIP/CAP BARREL	0.516"	PKGRAD2BU	LOWER CAP BARREL	0.525"	PKMUSBU	TIP BARREL
0.51"	PKTS100BU	CAP END BARREL	0.516"	PKGRADBU	CENTERBAND UPPER BARREL	0.528"	PKBIG-BU	CENTER LOWER BARREL
0.511"	PKAPBBU	CAP BARREL	0.516"	PKMAJJRBU	CENTER LOWER BARREL	0.528"	PKCPENRBU	CAP BARREL
0.511"	PKAPBBU	CENTERBAND UPPER BARREL	0.516"	PKMAJJRBU	END CAP BARREL	0.528"	PKSERBU	CENTER BARREL
0.511"	PKCAMBU	CAP BARREL	0.516"	PKMJJRCBU	LOWER BARREL BUSHING BARREL	0.53"	PKFPENBU	CENTER UPPER BARREL
0.511"	PKCMRBU	CENTER LOWER BARREL	0.517"	PKFLYRBU	CENTER LOWER BARREL	0.53"	PKGDRBBU	CENTER LOWER BARREL
0.512"	PKFILBU	CENTER BARREL	0.517"	PKFLYRBU	LOWER END BARREL	0.53"	PKGDRBBU	END CAP BARREL
0.513"	PKDBBUA	CENTER LOWER BARREL	0.517"	PKFPENBU	CENTER LOWER BARREL	0.53"	PKGRIND8BU	BUTTON BUSHING EXTENSION
0.513"	PKDBBUA	END CAP BARREL	0.518"	PKMONT-BUX	SIZING SLEEVE CENTERBAND DIAMETER	0.53"	PKPLI2-BU	TOP/BOTTOM EXTENSION
0.513"	PKSERBU	CAP BARREL	0.519"	PKPOLICEBU	CAP BARREL	0.53"	PKRASTBU	END BARREL BARREL
0.514"	PKARTBU	CENTER LOWER BARREL	0.52"	PKBCPBU	CENTER UPPER BARREL	0.531"	PKSKULLRBU	CENTER LOWER BARREL
0.514"	PKARTBU	LOWER CAP BARREL	0.52"	PKCONBU	CAP BARREL	0.531"	PKSPDRBU	END BUSHING BARREL

DIA.	BUSHING	SECTION	DIA.	BUSHING	SECTION	DIA.	BUSHING	SECTION
0.532"	PKAPCEBU	UPPER BLANK EXTENSION	0.545"	PKMAJBU	CENTER UPPER EXTENSION	0.553"	PKBS28CBU	END BUSHING BARREL
0.532"	PKAPR2BU	CENTER UPPER EXTENSION	0.545"	PKMAJBU	CLIP ASSEMBLY EXTENSION	0.554"	PKATOM-BU	CENTER BUSHING LOWER EXTENSION
0.532"	PKAPR2BU	CLIP ASSEMBLY EXTENSION	0.545"	PKVICRBU	CENTER BARREL	0.554"	PKATOM-BU	CENTER BUSHING UPPER EXTENSION
0.534"	PKTYBU	CENTER UPPER BARREL	0.545"	PKVICRBU	LOWER CAP BARREL	0.554"	PKATOM-BU	END BUSHINGS EXTENSION
0.535"	PKCP6000BU	CENTER UPPER EXTENSION	0.55"	PKCSCOOPBU	CAP BARREL	0.555"	PKAPR2BU	END CAP BARREL
0.535"	PKCP6000BU	CLIP ASSEMBLY EXTENSION	0.55"	PKCSCOOPBU	STEP BUSHING BARREL	0.555"	PKGDRBU	CAP/TIP BARREL
0.535"	PKGDRBBU	CENTER UPPER EXTENSION	0.55"	PKHPENBU	CAP BARREL	0.555"	PKHPRBU	CAP BARREL
0.535"	PKGDRBBU	CLIP ASSEMBLY EXTENSION	0.55"	PKMAJRB	CLIP ASSEMBLY BARREL	0.555"	PKSKULLRBU	LOWER BARREL
0.535"	PKMUSBU	CENTER LOWER BARREL	0.55"	PKMJRCBU	UPPER BARREL BUSHING BARREL	0.555"	PKVICRBU	UPPER CAP BARREL
0.538"	PKOL2BU	CENTER LOWER BARREL	0.55"	PKPIRBU	CENTER BARREL	0.561"	PKTYBU	CLIP ASSEMBLY BARREL
0.538"	PKOL2BU	ENDCAP BARREL	0.55"	PKRASAF2BU	TOP/BOTTOM BARREL	0.562"	PKISCOOPBU	HANDLE BUSHING TRIMMING BARREL
0.538"	PKOLCEBU	LOWER BARREL BUSHING BARREL	0.55"	PKSWPBU	CAP BARREL	0.562"	PKTYCEBU	UPPER BARREL BUSHING BARREL
0.54"	PKAPR2BU	CENTER LOWER BARREL	0.55"	PKSWPBU	CAP BARREL	0.563"	PKSAPENBU	CENTER BARREL
0.54"	PKDRABU	CENTER BARREL	0.55"	PKVICBU	CENTER BARREL	0.566"	PK50CALPBU	CENTER BARREL
0.54"	PKDRABU	TIP BARREL	0.55"	PKVICBU	TIP/CAP BARREL	0.568"	PK50BABU	CENTER TIP BASE BARREL
0.541"	PKCP6000BU	CENTER LOWER BARREL	0.551"	PKGRAD2BU	CAP BARREL	0.568"	PKFLYRBU	CAP BARREL
0.541"	PKCP6000BU	END CAP BARREL	0.551"	PKMUSRBU	CAP/CLIP BARREL	0.569"	PKCMRBU	CAP BARREL
0.544"	PKPLI-BU	CAP/TIP BARREL	0.551"	PKMUSRBU	CENTER LOWER BARREL	0.569"	PKCMRBU	CENTER UPPER BARREL
0.544"	PKPLI-BU	CENTER BARREL	0.551"	PKMUSRBU	LOWER CAP BARREL	0.57"	PKGRENBU	TIP BARREL
0.545"	PKEXECRBU	CAP BARREL	0.552"	PKARTBU	CAP BARREL	0.57"	PKMAJBU	END CAP BARREL
0.545"	PKEXECRBU	CENTER UPPER BARREL	0.553"	PKAPCEBU	LOWER BLANK BARREL	0.57"	PKMUSBU	CAP BARREL

DIA.	BUSHING	SECTION	DIA.	BUSHING	SECTION	DIA.	BUSHING	SECTION
0.571"	PK50CALBU	CENTER BARREL	0.591"	PKOL2BU	CLIP ASSEMBLY BARREL	0.625"	PKAPR2BU	CLIP ASSEMBLY BARREL
0.571"	PKCKBU	END BUSHING BARREL	0.592"	KSNECBU	END BUSHING BARREL	0.625"	PKBULPENBU	CENTER BARREL
0.571"	PKMAYBU	CAP BARREL	0.598"	PKMAJBU	CENTER LOWER BARREL	0.625"	PKCP6000BU	CENTER UPPER BARREL
0.572"	BS15BU	UPPER BARREL	0.6"	BS25XBU	CENTER BARREL	0.625"	PKCP6000BU	CLIP ASSEMBLY BARREL
0.575"	PKCPENRBU	CENTER UPPER BARREL	0.6"	BS25XBU	END BUSHING OPENER BARREL	0.625"	PKEZBU	CAP SLEEVE BARREL
0.575"	PKDBBUA	CENTER UPPER BARREL	0.6"	BS6-BU	CENTER CENTER BARREL	0.625"	PKGDPENBU	END BUSHINGS BARREL
0.575"	PKGRAD2BU	CENTER UPPER BARREL	0.6"	PKMAGNECBU	CENTER UPPER BARREL	0.625"	PKGDRBBU	CENTER UPPER BARREL
0.575"	PKMAJLOBU	END BUSHING BARREL	0.6"	PKMAGNECBU	UPPER CAP BARREL	0.625"	PKGDRBBU	CLIP ASSEMBLY BARREL
0.575"	PKSKULLBU	CAP/TIP BUSHING BARREL	0.6"	PKMUSBU	CENTER UPPER BARREL	0.628"	PKPLI2-BU	TOP/BOTTOM BARREL
0.575"	PKSKULLBU	CENTERBAND BARREL	0.6"	PKMUSRBU	CENTER UPPER BARREL	0.63"	PKSEPILLBU	END BUSHING BARREL
0.576"	PKBIG-BU	CENTER UPPER BARREL	0.6"	PKSPENBU	CENTER BARREL	0.638"	PKDRRBU	CENTER LOWER BARREL
0.576"	PKMAJJRBU	CENTER UPPER BARREL	0.6"	PKVPENBU	CAP ASSEMBLY BARREL	0.638"	PKDRRBU	TIP END BARREL
0.576"	PKSPCL2BU	CAP BARREL	0.6"	PKWESTBU	CAP BARREL	0.638"	PKSPRTBU	HOLDER END BARREL
0.58"	PKDRABU	CAP BARREL	0.603"	PKSKULLRBU	CENTER UPPER BARREL	0.64"	PKAPCEBU	UPPER BLANK BARREL
0.583"	PKFLYRBU	CENTER UPPER BARREL	0.603"	PKTANKBU	CAP / TIP BARREL	0.642"	PKAPR2BU	CENTER UPPER BARREL
0.583"	PKSKULLRBU	UPPER BARREL	0.607"	PKARTBU	CENTER UPPER BARREL	0.642"	PKOLCEBU	UPPER BARREL BUSHING BARREL
0.585"	PKCLFPBU	END BUSHING BARREL	0.61"	PKHPRBU	CENTER UPPER BARREL	0.647"	PKDBBUA	CLIP ASSEMBLY BARREL
0.585"	PKCWPENBU	CAP BARREL	0.615"	PKATOMKCBU	END BUSHING BARREL	0.65"	PKGRENBU	CAP BARREL
0.585"	PKDRRBU	UPPER END BARREL	0.623"	PKLSBU	CENTERBAND BARREL	0.65"	PKMAJBU	CENTER UPPER BARREL
0.585"	PKWDYBU	CAP END BARREL	0.623"	PKLSBU	END BUSHING BARREL	0.65"	PKMAJBU	CLIP ASSEMBLY BARREL
0.585"	PKWDYBU	TIP MAIN DIAMETER	0.623"	PKPCUBU	ANGLE SLEEVE BARREL	0.652"	PKDRRBU	CENTER UPPER BARREL

DIA.	BUSHING	SECTION	DIA.	BUSHING	SECTION	DIA.	BUSHING	SECTION
0.655"	PKFCBU	TRIM SLEEVE OUTER DIAMETER	0.806"	KSEG-M	END BUSHINGS EXTENSION	1.35"	PKSPKSBU	BASE BARREL
0.655"	PKOL2BU	CENTER UPPER BARREL	0.83"	PKISCOOPBU	HANDLE BUSHING TURNING BARREL	1.568"	PKDCM1916	MANDREL FACEPLATE
0.656"	PKATOM-BU	CENTER BUSHING BARREL	0.841"	BSLEDBU	STOPPER END BARREL	1.67"	PKSTANDYBU	TOP BARREL
0.656"	PKATOM-BU	END BUSHINGS BARREL	0.845"	PKLBALMBU	END BUSHING BARREL	1.83"	PKSTANDYBU	BOTTOM BARREL
0.658"	PKFCBU	END BUSHINGS EXTENSION	0.87"	PKGRIND8BU	BUTTON BUSHING BARREL	2"	PKDCM200	CHUCK MANDREL FACEPLATE
0.699"	PKLBALMBU	END BUSHING EXTENSION	0.873"	KSEG-M	END BUSHINGS BARREL			
0.699"	PKSPKSBU	BASE EXTENSION	0.875"	BS11GSBU	TOP RECESS BUSHING			
0.699"	PKSPKSBU	TOP EXTENSION	0.875"	PKEZBU	CAP SLEEVE SCREW HOLDER			
0.7"	PKMONT-BUX	SIZING SLEEVE HOLDER & SET SCREW	0.925"	PKDCM100	MANDREL FACEPLATE			
0.703"	PKBEGBU	END BARREL	0.93"	BS12GABU	SHORT BUSHING BEADING SIDE			
0.72"	BS12GABU	LONG BUSHING TENON SIDE	0.932"	PKTOOL2BU	CAP/TIP BARREL			
0.735"	PK50BABU	CENTER CARTRIDGE FRONT BARREL	0.96"	PK-BS1-MJ	SIZING DIAMETER BARREL			
0.74"	PKSTANDYBU	BOTTOM EXTENSION	0.985"	PKSANDPBU	END BUSHING EXTENSION			
0.74"	PKSTANDYBU	TOP EXTENSION	0.995"	PKDCMBS	CHUCK MANDREL FACEPLATE			
0.75"	PKPCUBU	ANGLE SLEEVE SCREW HOLDER	1.04"	PKDCMPT	CHUCK MANDREL FACEPLATE			
0.77"	PK50BABU	BACK END CARTRIDGE BACK BARREL	1.054"	PKGRIND7BU	TOP/BOTTOM EXTENSION			
0.78"	BS12GABU	SHORT BUSHING CYLINDER SIDE	1.125"	PKSANDPBU	END BUSHING BARREL			
0.78"	PKTOOL2BU	CAP/TIP EXTENSION	1.2"	PKSPKSBU	TOP BARREL			
0.8"	PKBSBU	CHUCK BUSHING OUTER DIAMETER	1.25"	PKDCM125	MANDREL FACEPLATE			
0.8"	PKFCBU	END BUSHINGS BARREL	1.26"	PKPHANGM	DRILL CHUCK MANDREL FACEPLATE			
0.802"	BS12GABU	LONG BUSHING CYLINDER SIDE	1.325"	PKGRIND7BU	TOP/BOTTOM FLANGE			